

View from Top side (Scale 2:1)

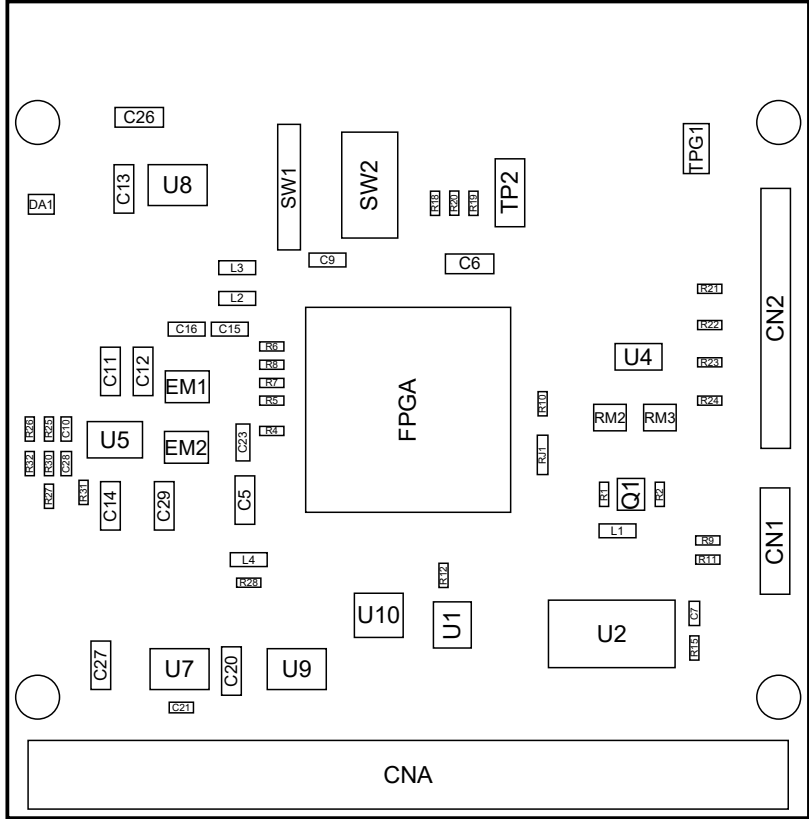

View from Bottom side (Scale 2:1)

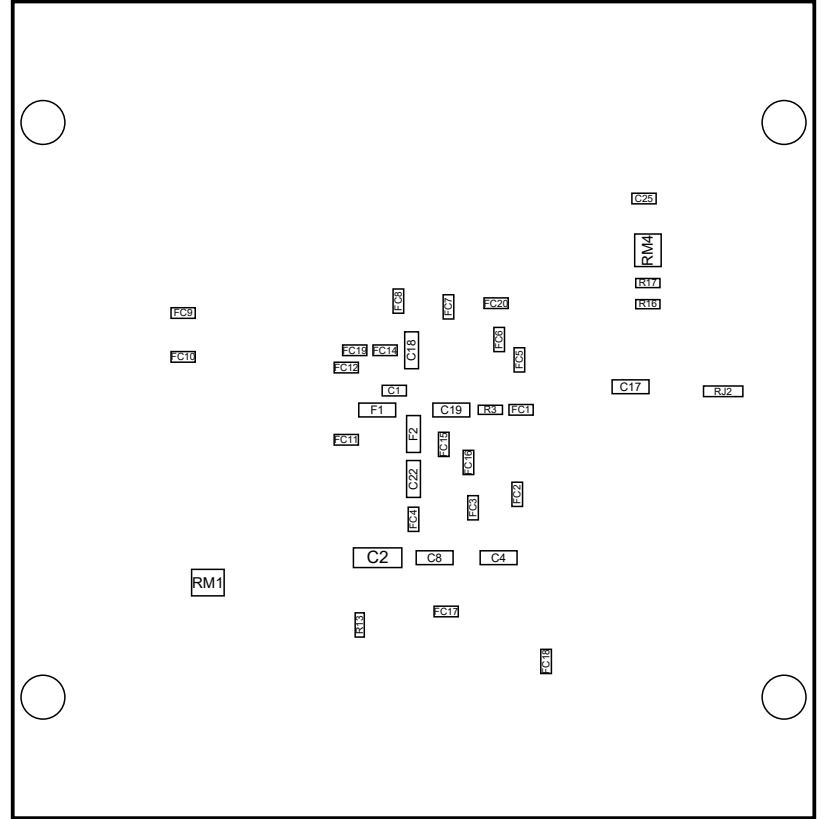

PCB Version : B



HuMANDATA LTD.
www.hdl.co.jp/ (Japan)
www2.hdl.co.jp/en/ (Global)

DSN	TITLE: XCM-308 PCB Drawing	
	DOC.No: PCB-XCM-308	REV B
	FILE:	DATE: 2023/03/20

Sheet: 1 / 2

Top Layer (Scale 1:1)

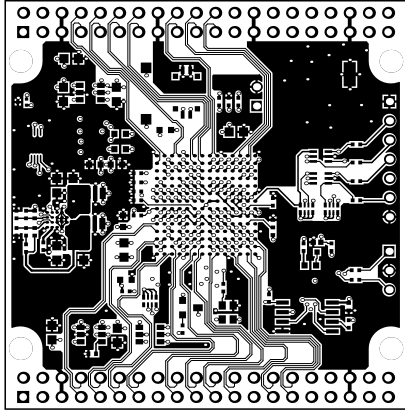

Signal Layer1 (Scale 1:1)

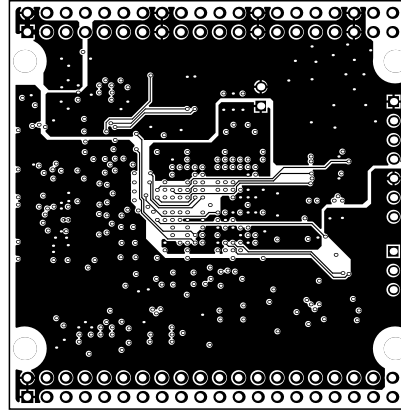

Internal Plane2 (Scale 1:1)

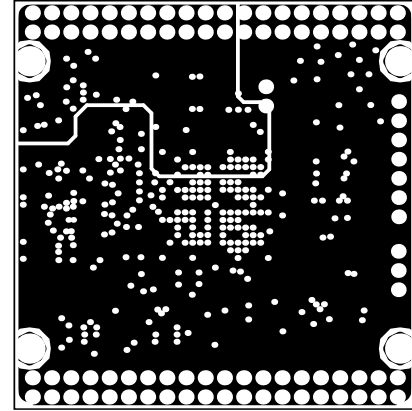

Internal Plane1 (Scale 1:1)

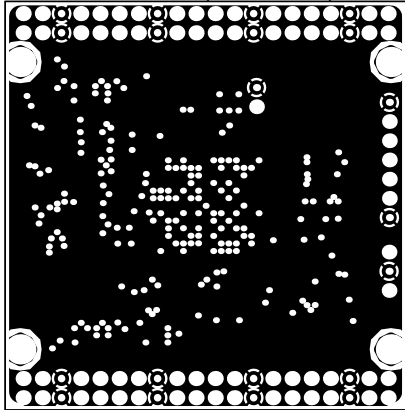

Signal Layer2 (Scale 1:1)

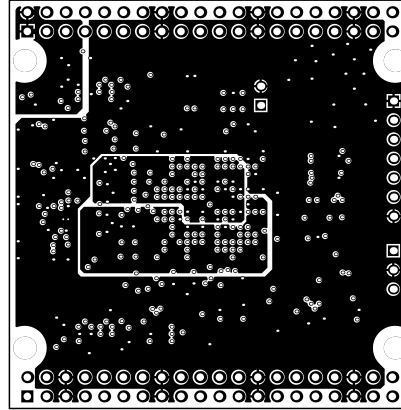

Bottom Layer (Scale 1:1)

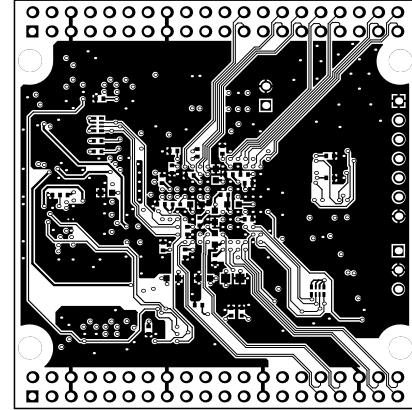

PCB Version : B

HUMANDATA

HuMANDATA LTD.
www.hdl.co.jp/ (Japan)
www2.hdl.co.jp/en/ (Global)

DSN

TITLE:

XCM-308 PCB Drawing

DOC.No:

PCB-XCM-308

REV

B

FILE:

DATE: 2023/03/20

Sheet: 2 / 2

V1_20191224