

View from Top side (Scale 2:1)

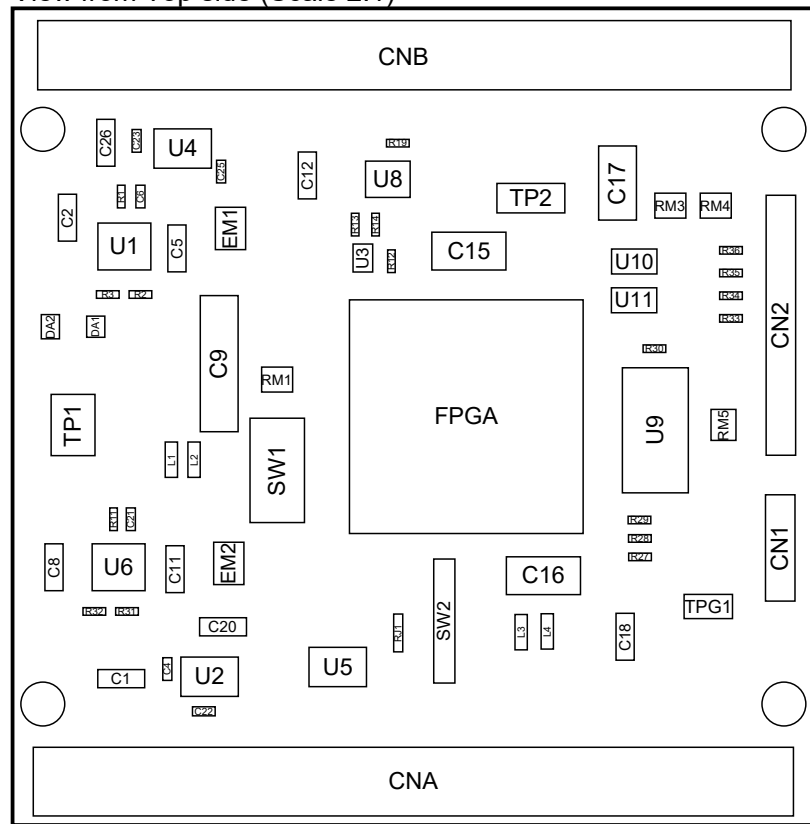

View from Bottom side (Scale 2:1)

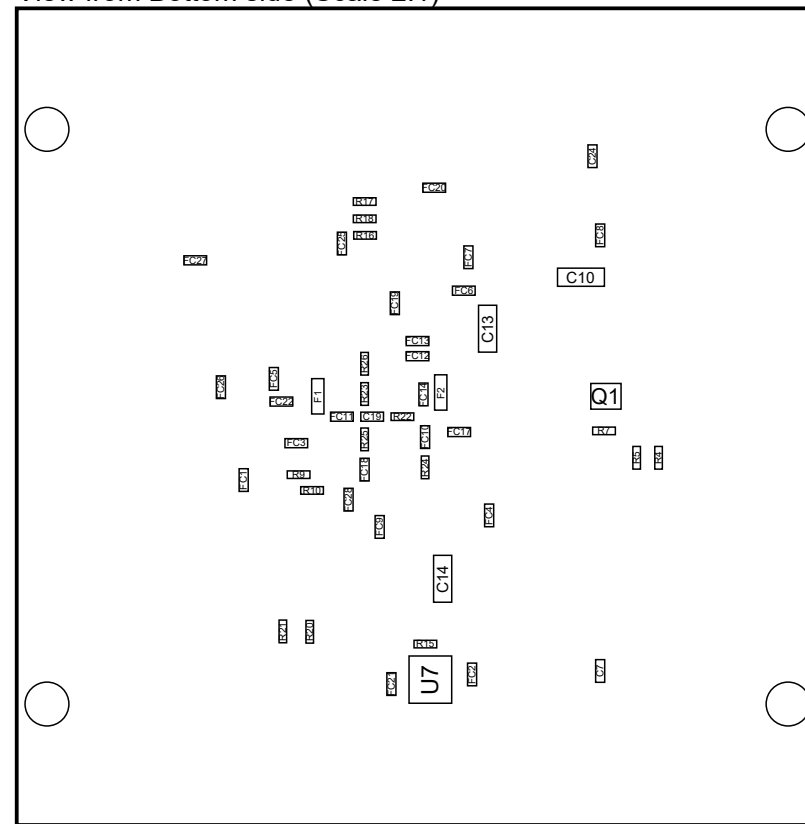

PCB Version : B



HuMANDATA LTD.  
[www.hdl.co.jp/](http://www.hdl.co.jp/) (Japan)  
[www2.hdl.co.jp/en/](http://www2.hdl.co.jp/en/) (Global)

DSN	TITLE: XCM-307 PCB Drawing	
	DOC.No: PCB-XCM-307	REV A
	FILE:	DATE: 2023/04/10

Sheet: 1 / 2

1

2

3

4

5

A

B

C

D

A

B

C

D

TopLayer (Scale 1:1)

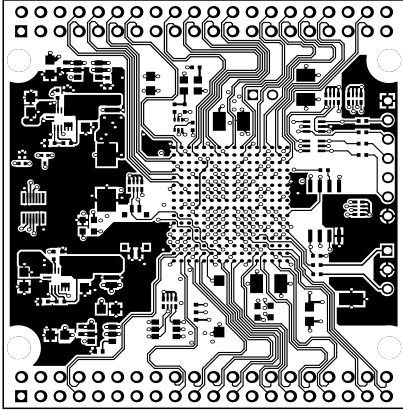

Signal Layer 1 (Scale 1:1)

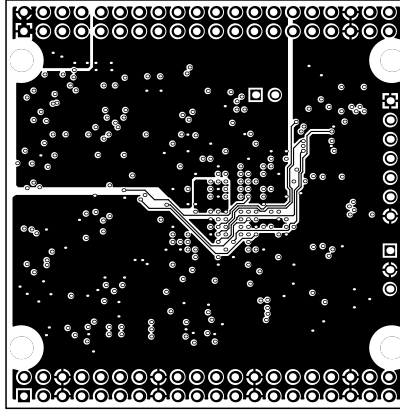

Internal Plane2 (Scale 1:1)

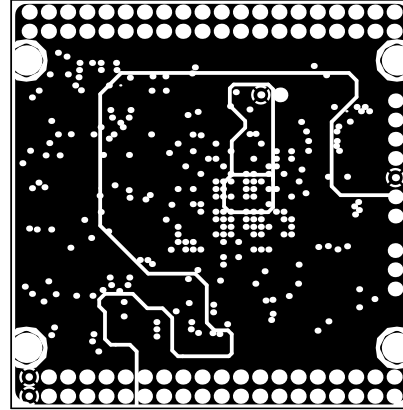

InternalPlane1 (Scale 1:1)

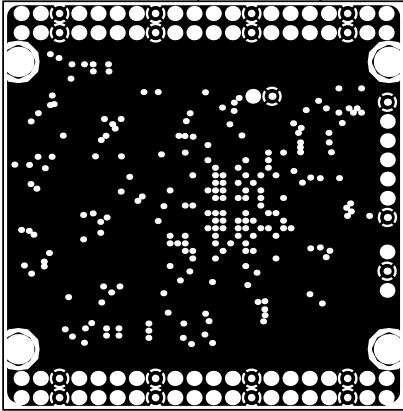

Signal Layer 2 (Scale 1:1)

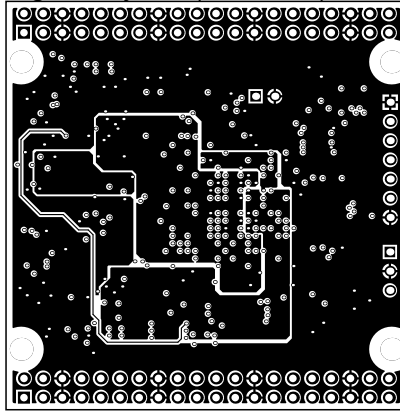

BottomLayer (Scale 1:1)

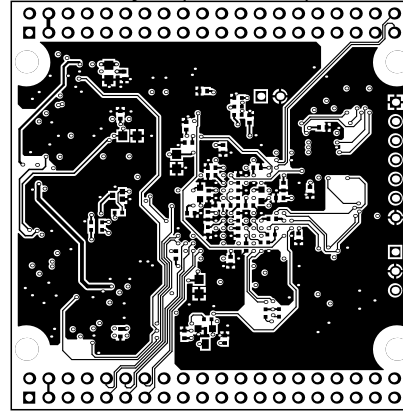

PCB Version : B



HuMANDATA LTD.  
www.hdl.co.jp/ (Japan)  
www2.hdl.co.jp/en/ (Global)

DSN

TITLE:

XCM-307 PCB Drawing

DOC.No:

PCB-XCM-307

REV

A

FILE:

DATE: 2023/04/10

Sheet: 2 / 2

1

2

3

4

5

V1\_20191224