

TOP LAYER

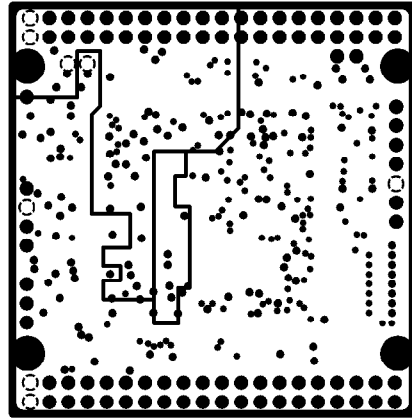

INTERNAL PLANE2(VCC)

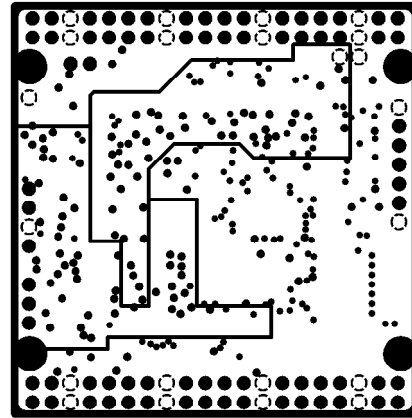

INTERNAL PLANE4

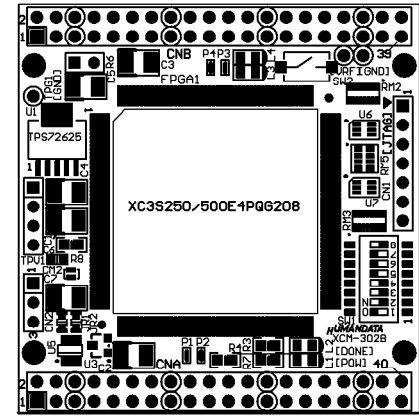

部品面

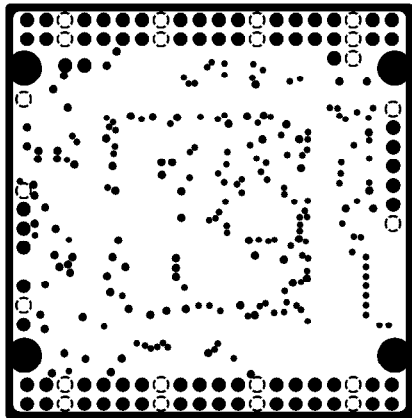

INTERNAL PLANE1(GND)

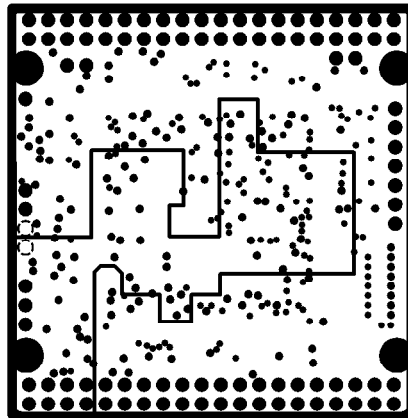

INTERNAL PLANE3

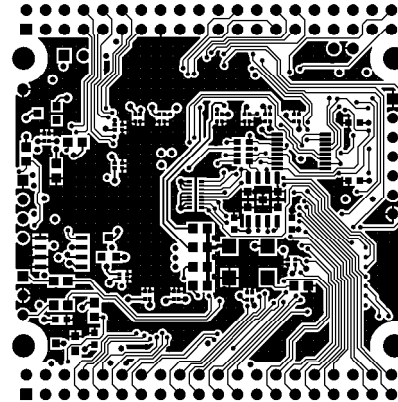

BOTTOM LAYER

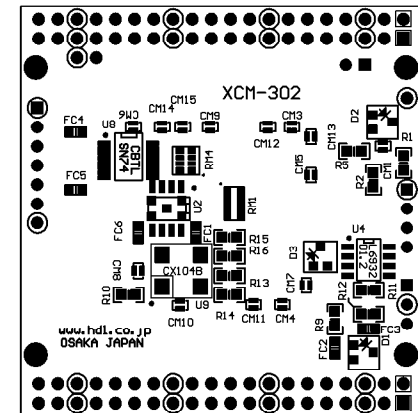

はんだ面

HUMANDATA		UNIT	TITLE	
CHK	DWG	SIZE	XCM-302Bパターン図	
			DWG NO	XCM-302.ART
			REV	A

