

1 2 3 4 5 6 7 8

A

A

B

B

C

C

D

D

View from Top side (Scale 2:1)

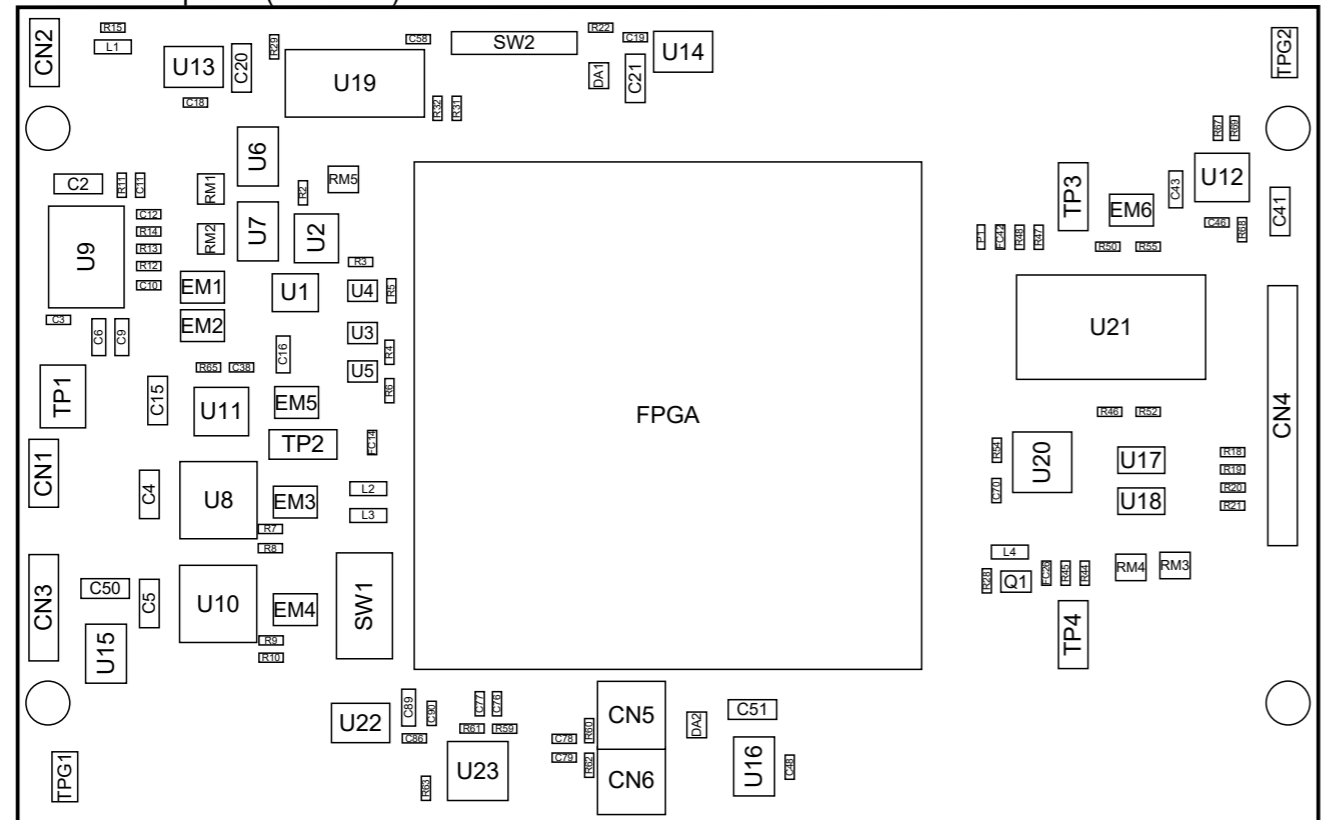

View from Bottom side (Scale 2:1)

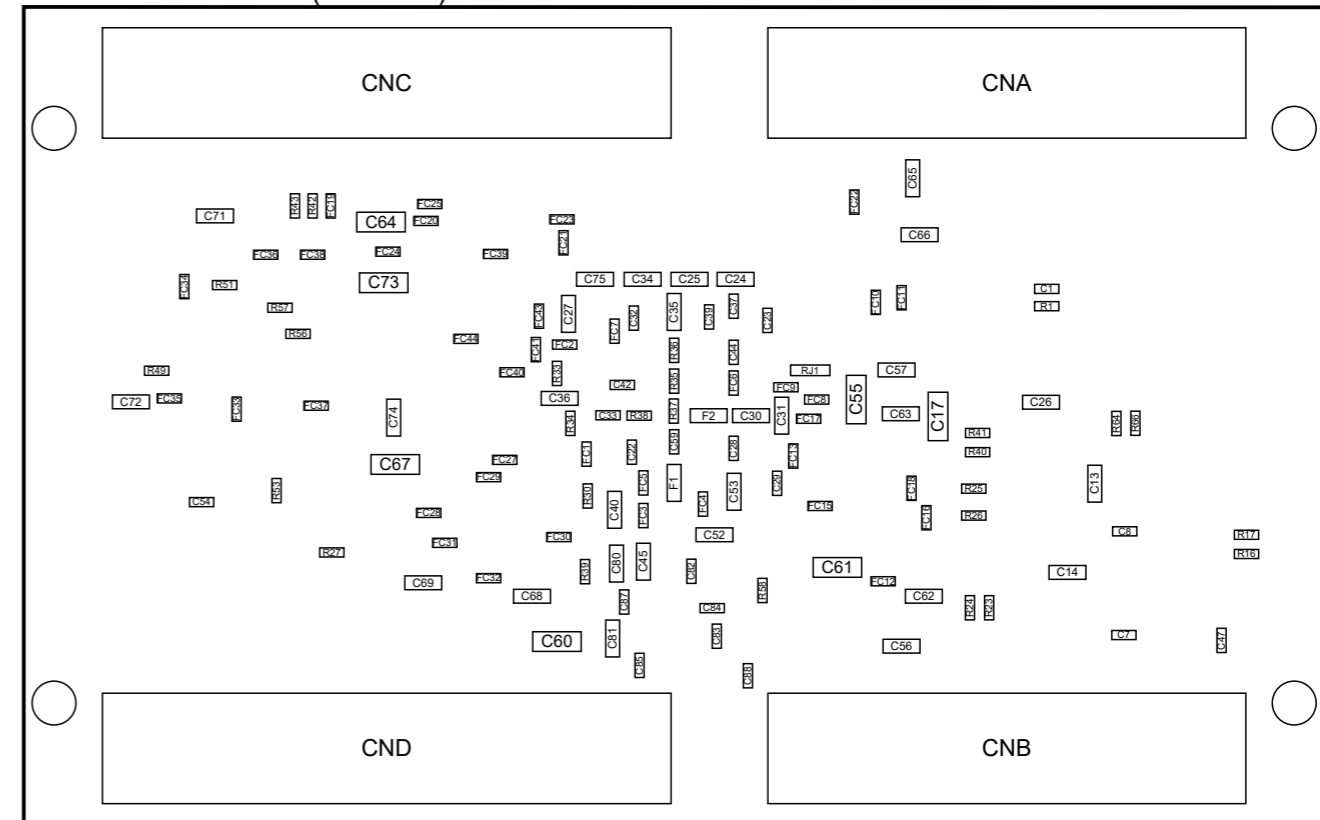

PCB Version : B



HuMANDATA LTD.
www.hdl.co.jp/ (Japan)
www2.hdl.co.jp/en/ (Global)

DSN	TITLE: XCM-211 PCB Drawing		REV B
	DOC.No: PCB-XCM-211		
	FILE:	DATE: 2023/03/09	

1 2 3 4 5 6 7 8

1

2

3

4

5

6

7

8

A

Top Layer (Scale 1:1)

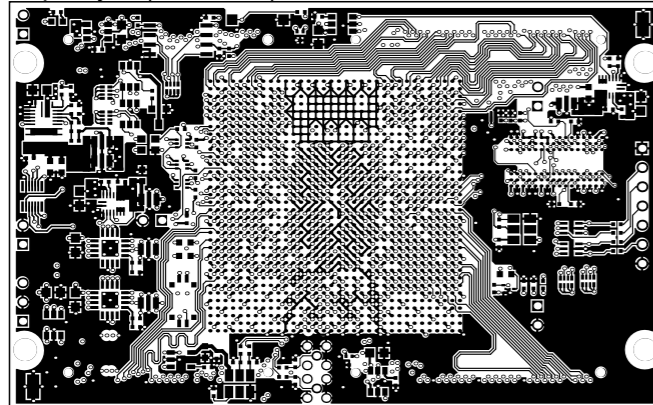

Signal Layer 2 (Scale 1:1)

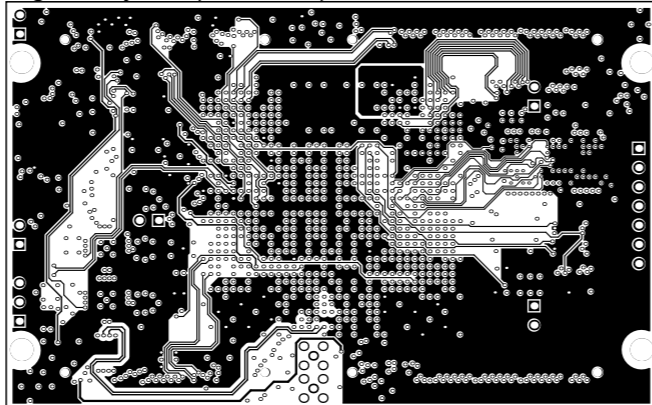

Signal Layer 3 (Scale 1:1)

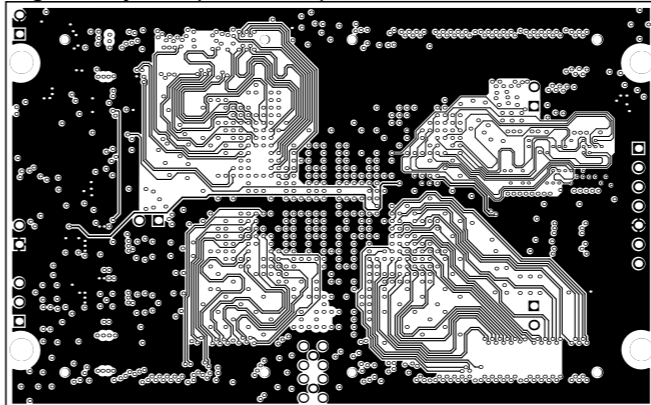

Power Plane (GND2) (Scale 1:1)

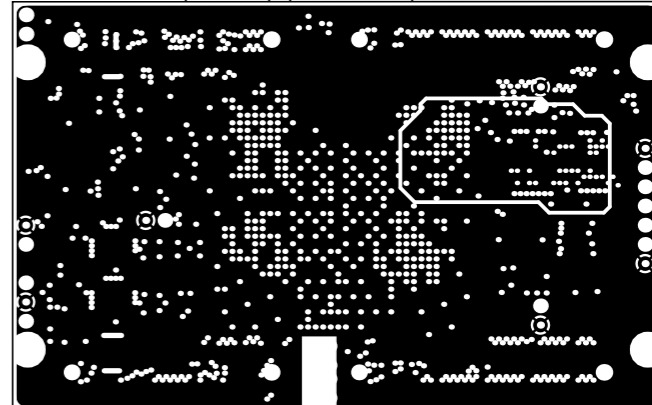

A

B

Ground Plane (GND) (Scale 1:1)

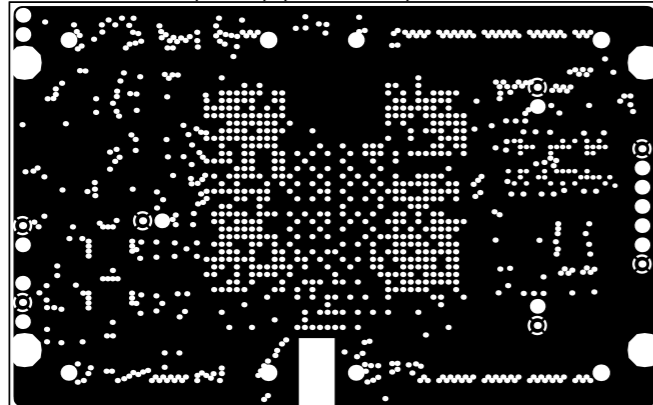

Internal Plane 1 (Scale 1:1)

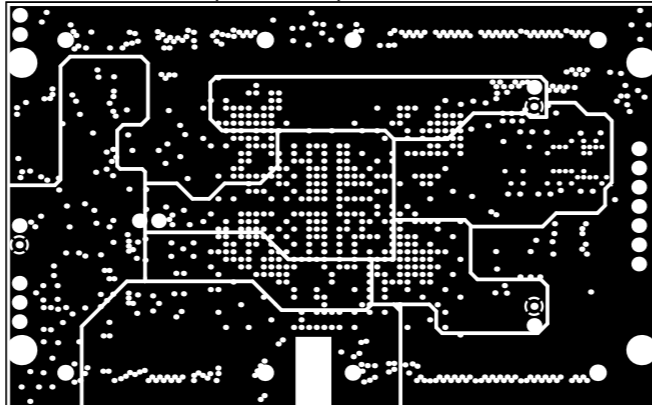

Signal Layer 4 (Scale 1:1)

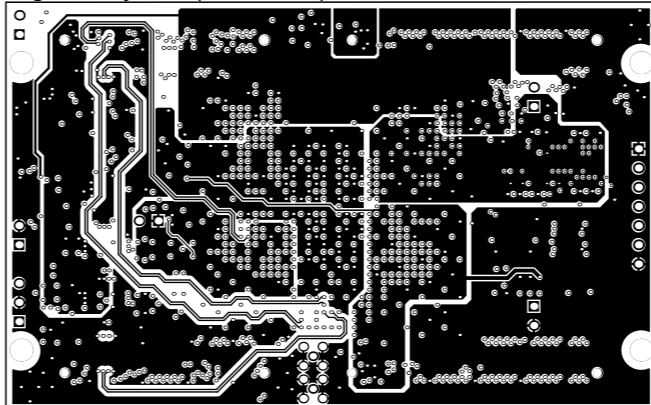

Bottom Layer (Scale 1:1)

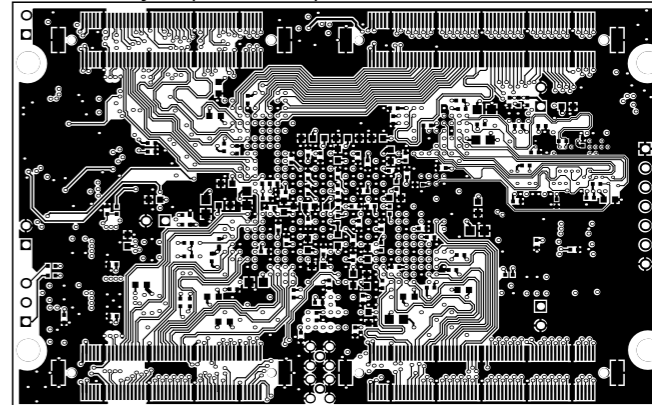

B

C

Signal Layer 1 (Scale 1:1)

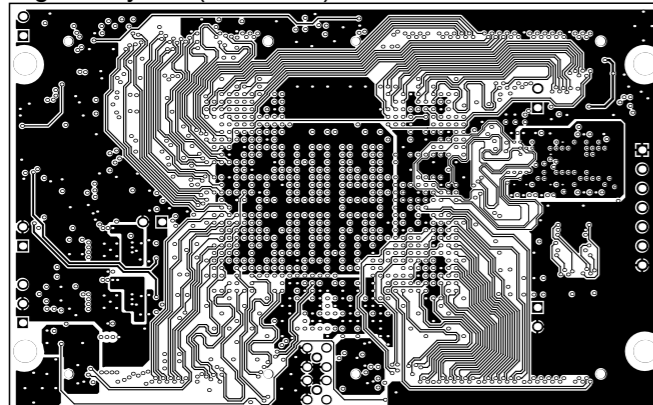

Internal Plane 2 (Scale 1:1)

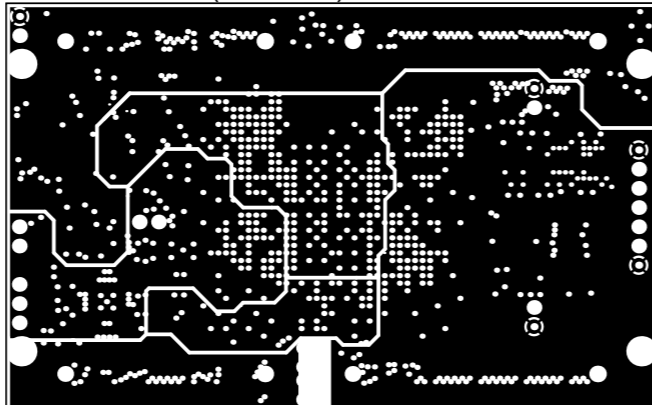

Power Plane (GND2) (Scale 1:1)

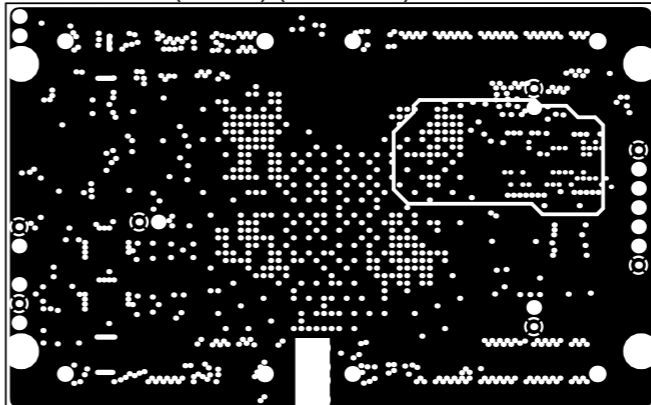

C

D

PCB Version : B



HuMANDATA LTD.
www.hdl.co.jp/ (Japan)
www2.hdl.co.jp/en/ (Global)

DSN

TITLE:
XCM-211 PCB Drawing

DOC.No:
PCB-XCM-211

REV
B

FILE: DATE: 2023/03/09 Sheet: 2 / 2

V2_20210721

1

2

3

4

5

6

7

8

D