

DSN:	TITLE: KINTEX-7 FFG900 FPGA Board
DOC. No: XCM-209	B
FILE: XCM209.SchDoc	DATE: 2017/03/01 11:06:06 Sheet: 1 / 8

PEN_N1	PEN_N1
PEN_N2	PEN_N2
PEN_N3	PEN_N3

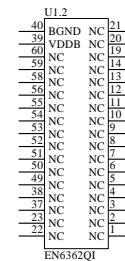
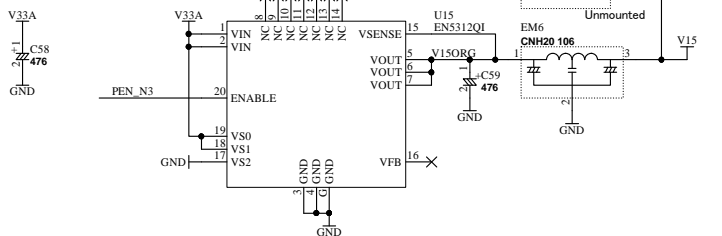
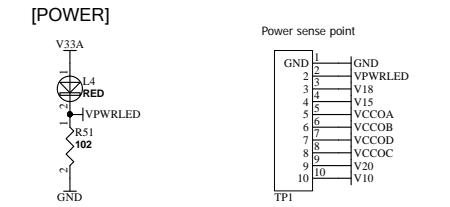
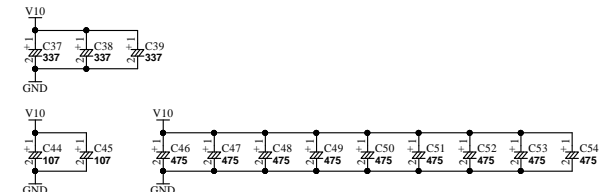
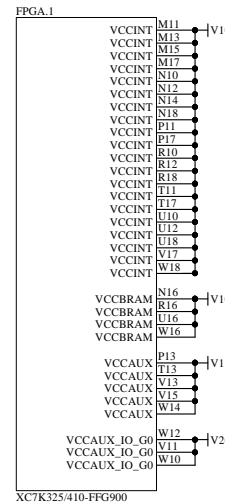
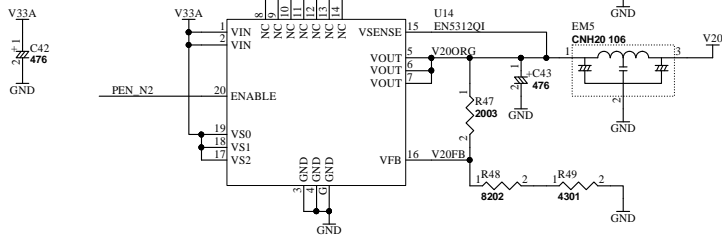
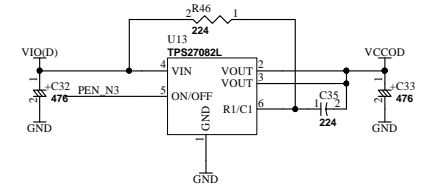
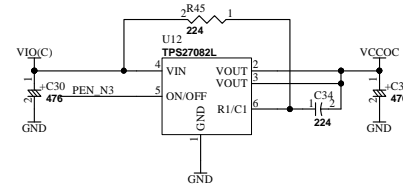
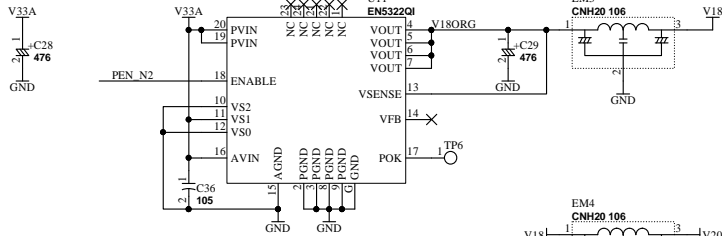
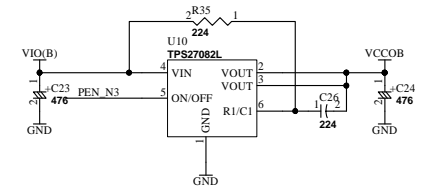
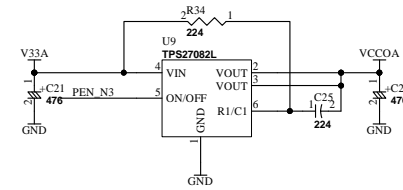
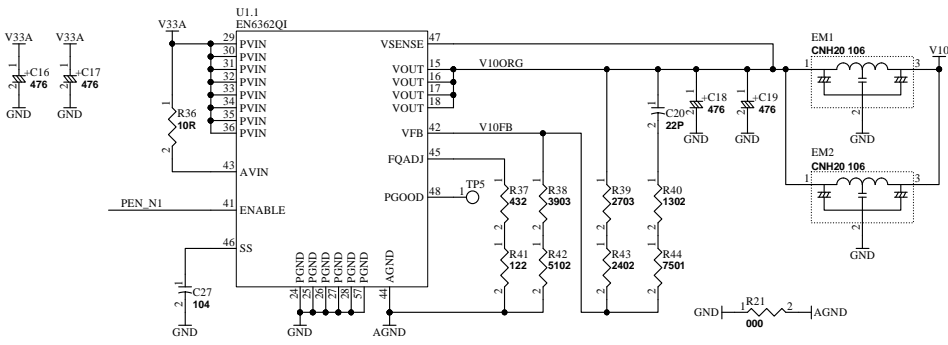

XC7K325/410-FPG900

XCM0209R1-SCH-B.pdf



DSN:	TITLE: KINTEX-7 FFG900 FPGA Board	
DOC. No:	XCM-209	B
FILE: POWER.SchDoc	DATE: 2017/03/01 11:06:06	Sheet: 2 / 8

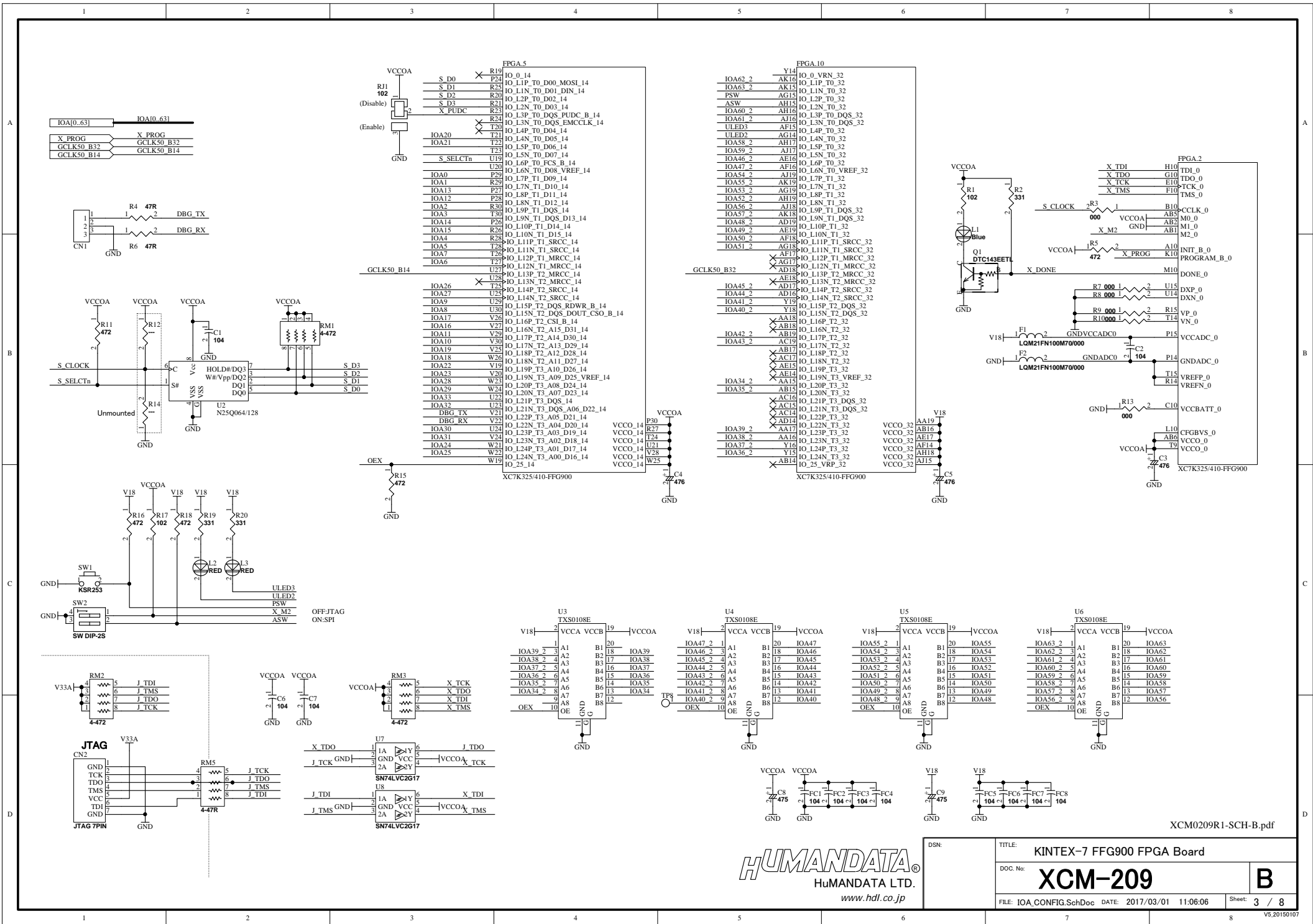

XCM0209R1-SCH-B.pdf



DSN:		TITLE: KINTEX-7 FFG900 FPGA Board	
DOC. No:		XCM-209	
FILE: IOA.CONFIG.SchDoc		DATE: 2017/03/01 11:06:06	Sheet: 3 / 8

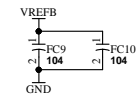
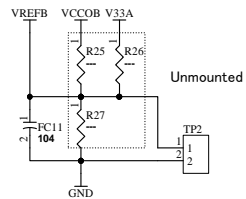
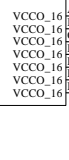
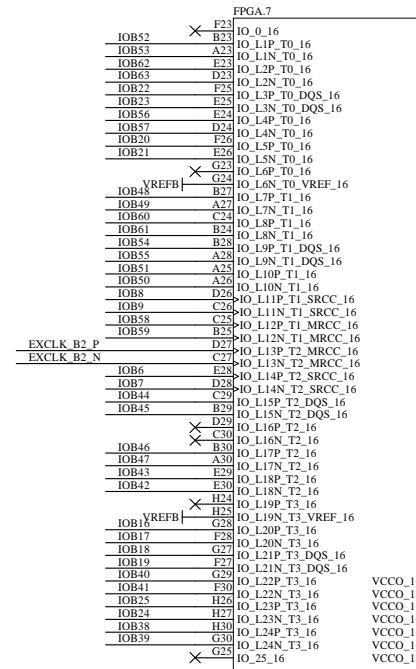
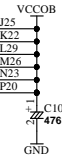
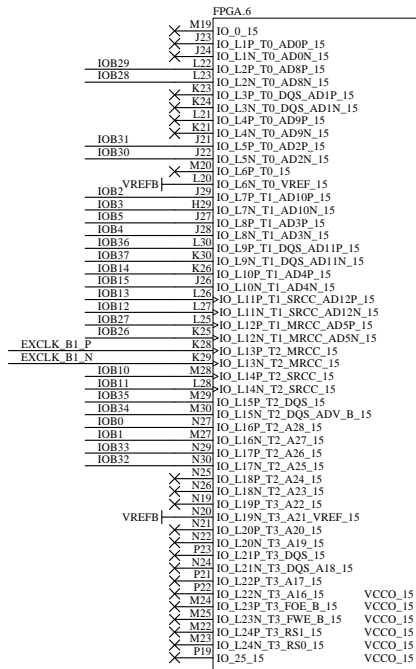
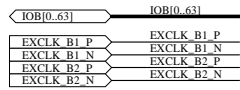

XCM0209R1-SCH-B.pdf



DSN:	TITLE: KINTEX-7 FFG900 FPGA Board
DOC. No:	XCM-209
FILE: IOB.SchDoc	DATE: 2017/03/01 11:06:06
Sheet: 4 / 8	B

IOC[0..83]	IOC[0..83]
EXCLK C1 P	EXCLK C1 P
EXCLK C1 N	EXCLK C1 N
EXCLK C2 P	EXCLK C2 P
EXCLK C2 N	EXCLK C2 N

FPGA3	
IOC78	Y20
IOC79	Y24
IOC63	Y21
IOC62	AA21
IOC61	AB22
IOC60	AB23
IOC76	AA23
IOC77	AA25
IOC69	AC20
IOC68	AC21
	AA20
	AB20
VREFC	AB24
IOC72	AC25
IOC73	AC25
IOC59	AC22
IOC58	AD22
IOC71	AC24
IOC70	AD24
IOC67	AD21
IOC66	AE21
IOC55	AE23
IOC54	AF23
IOC57	AD23
IOC56	AE24
IOC75	AF22
IOC74	AG23
IOC21	AG24
IOC20	AH24
IOC14	AJ24
IOC15	AK25
IOC53	AE25
IOC52	AF25
IOC19	AK23
IOC18	AK24
IOC41	AG25
IOC40	AH25
	AD20
VREFC	AD21
IOC65	AG22
IOC64	AH22
IOC23	AJ22
IOC22	AJ23
IOC29	AG20
IOC28	AH20
IOC25	AH21
IOC24	AJ21
IOC27	AK20
IOC26	AK21
	AK22
	Y22
	AE20

FPGA4	
IOC83	Y25
IOC82	AA26
IOC30	W27
IOC31	W28
IOC34	Y28
IOC35	AA28
IOC32	W29
IOC33	Y29
IOC81	AA27
IOC80	AB28
	AA25
	AB25
VREFC	AB23
IOC7	AC29
IOC6	AC30
IOC5	Y30
IOC4	AA30
IOC45	AD29
IOC44	AE29
IOC2	AB29
IOC3	AB30
IOC39	AD27
IOC38	AD28
EXCLK C1 P	AB27
EXCLK C1 N	AC27
EXCLK C2 P	AG29
EXCLK C2 N	AH29
	AE28
IOC37	AE28
IOC36	AF28
IOC1	AK29
IOC0	AK30
IOC13	AE30
IOC12	AF30
IOC43	AJ28
IOC42	AJ29
IOC9	AG30
IOC8	AH30
	AC26
VREFC	AD26
IOC1	AJ27
IOC10	AK28
IOC49	AG27
IOC48	AG28
IOC47	AH26
IOC46	AH27
IOC51	AF26
IOC50	AF27
IOC16	AJ26
IOC17	AK26
	AE26

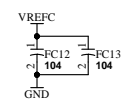
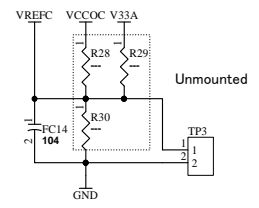
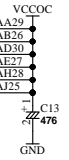

HUMAN DATA
 HuMANDATA LTD.
 www.hdl.co.jp

DSN:	TITLE: KINTEX-7 FFG900 FPGA Board
DOC. No:	XCM-209
FILE: IOC.SchDoc	DATE: 2017/03/01 11:06:07
Sheet: 5 / 8	B

XCM0209R1-SCH-B.pdf

IOD[0..83]		IOD[0..83]	
EXCLK D1 P	EXCLK D1 P	EXCLK D1 N	EXCLK D1 N
EXCLK D2 P	EXCLK D2 P	EXCLK D2 N	EXCLK D2 N

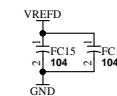
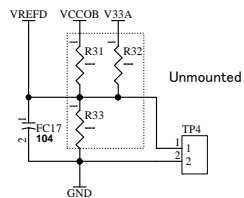
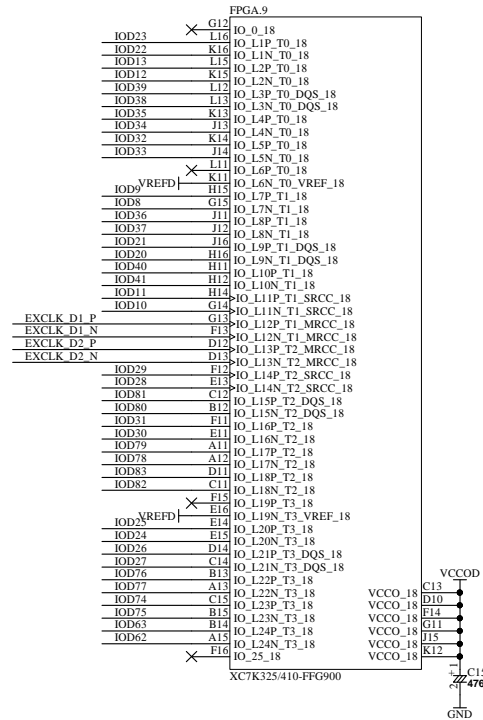
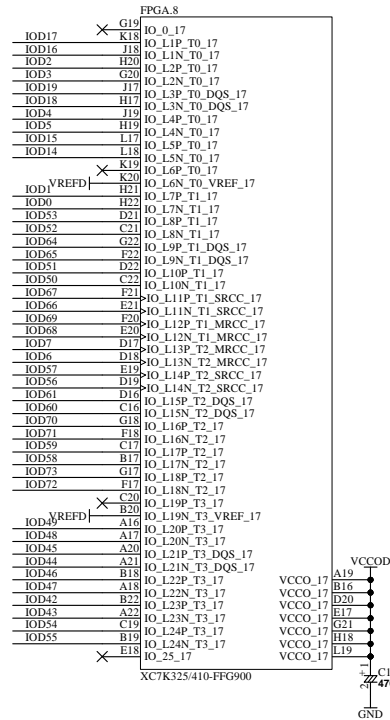

HUMAN DATA
HuMANDATA LTD.
www.hdl.co.jp

DSN:	TITLE: KINTEX-7 FFG900 FPGA Board
DOC. No:	XCM-209
FILE: IOD.SchDoc	DATE: 2017/03/01 11:06:07
Sheet: 6 / 8	B

XCM0209R1-SCH-B.pdf

