

PEN N1	PEN N1
PEN N2	PEN N2
PEN N3	PEN N3

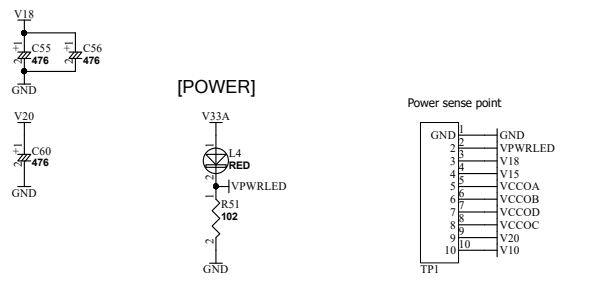

40	BGND	NC	21
39	VDDB	NC	20
60	NC	NC	19
59	NC	NC	14
58	NC	NC	13
57	NC	NC	12
56	NC	NC	11
55	NC	NC	10
54	NC	NC	9
53	NC	NC	8
52	NC	NC	7
51	NC	NC	6
50	NC	NC	5
49	NC	NC	4
38	NC	NC	3
37	NC	NC	2
23	NC	NC	1
22	NC	NC	

XCM0209R2-SCH-B1.pdf

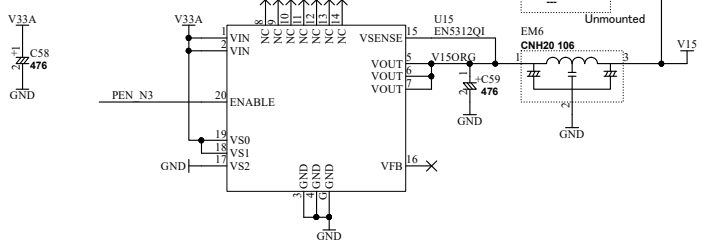
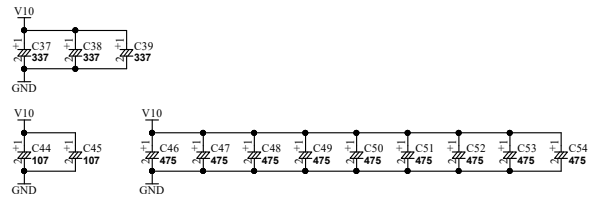
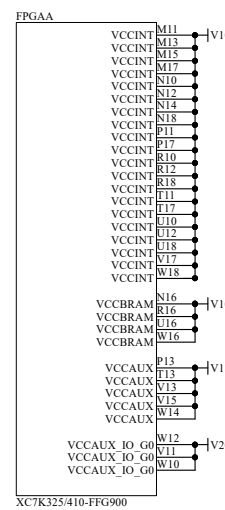
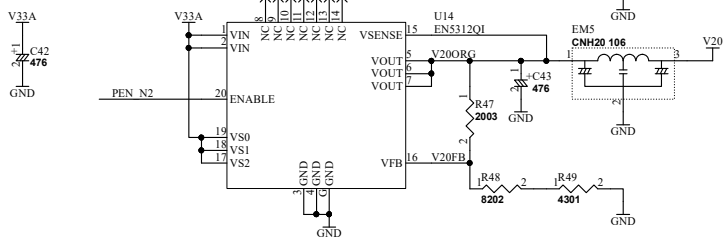
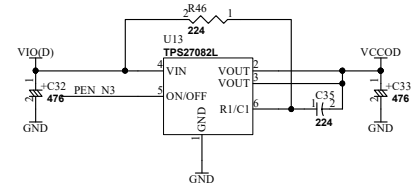
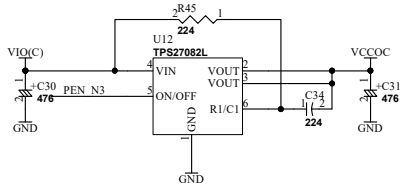
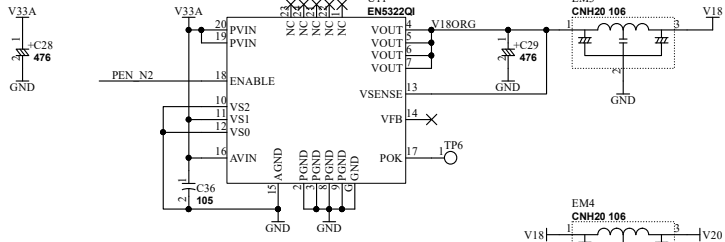
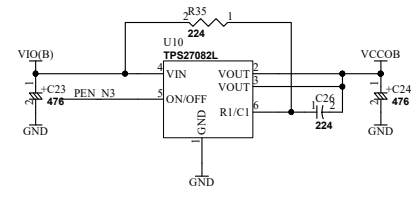
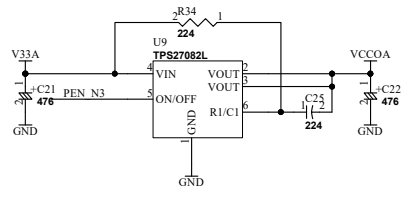
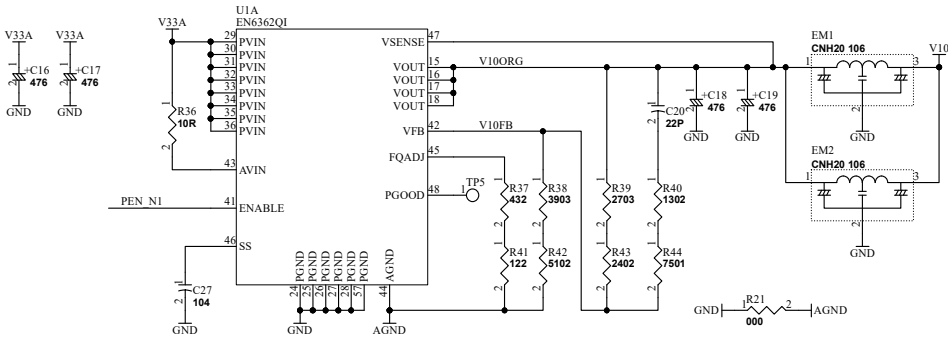

DSN:	TITLE: KINTEX-7 FFG900 FPGA Board	
DOC. No:	XCM-209	B1
FILE: POWER.SchDoc	DATE: 2020/03/09 9:46:38	Sheet: 2 / 8

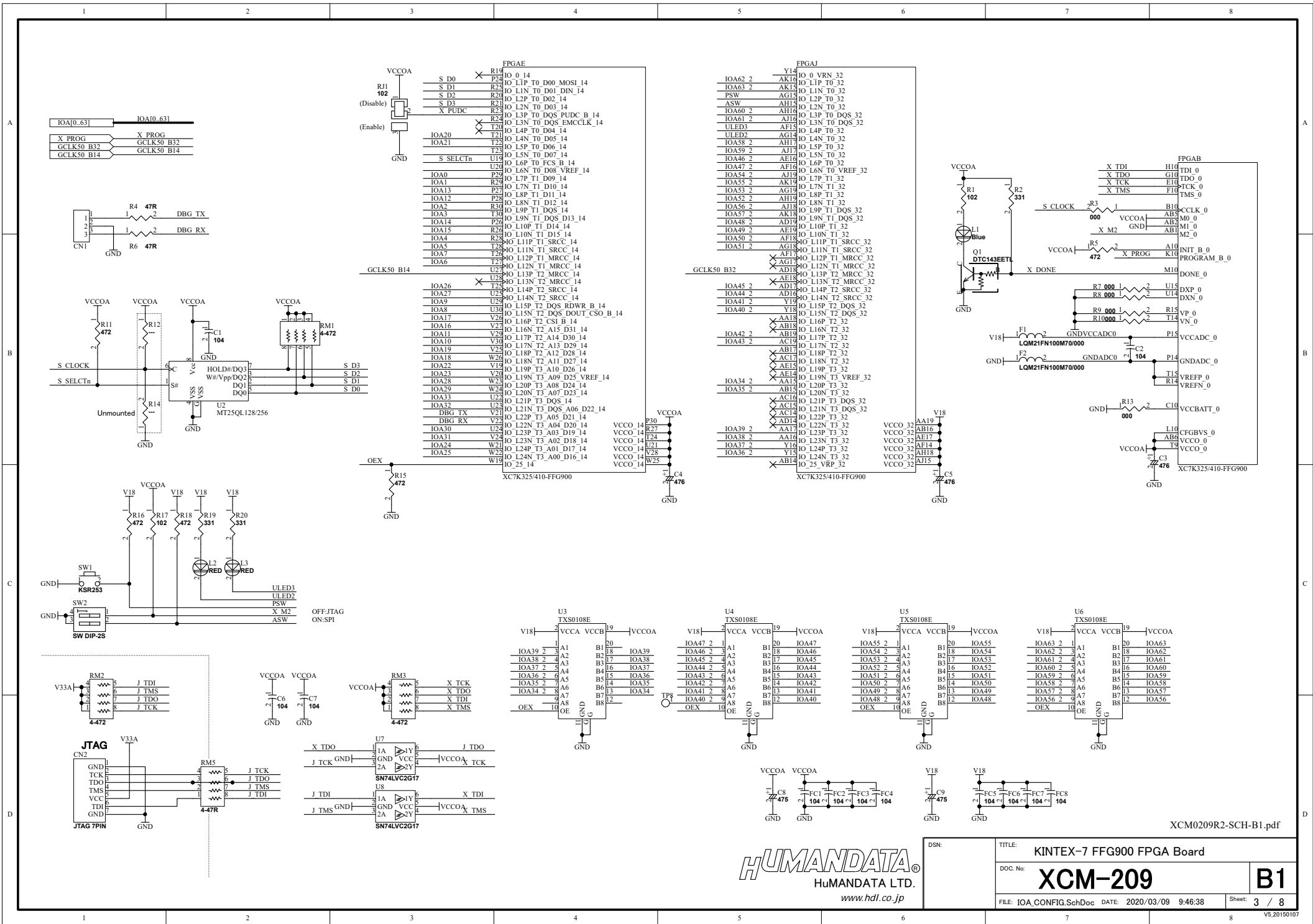

DSN:	TITLE: KINTEX-7 FFG900 FPGA Board	B1
DOC. No:	XCM-209	
FILE: IOA.CONFIG.SchDoc	DATE: 2020/03/09 9:46:38	Sheet: 3 / 8

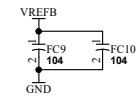
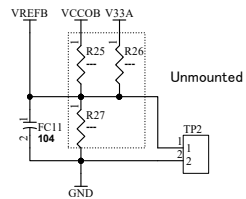
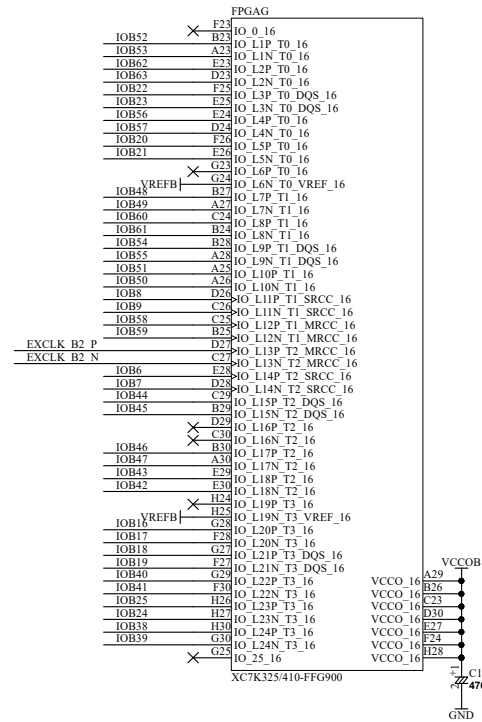
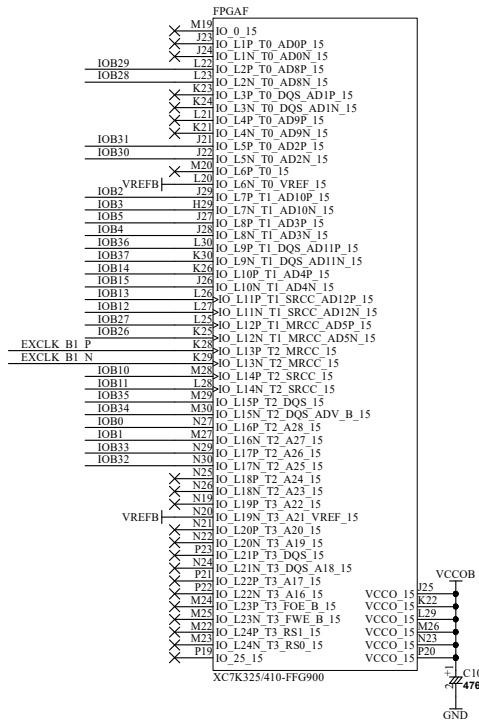
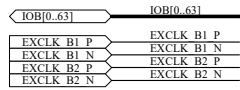

XCM0209R2-SCH-B1.pdf



DSN:	TITLE: KINTEX-7 FFG900 FPGA Board
DOC. No:	XCM-209
FILE: IOB.SchDoc	DATE: 2020/03/09 9:46:38
Sheet: 4 / 8	B1

IOCI0_831	
EXCLK C1 P	EXCLK C1 P
EXCLK C1 N	EXCLK C1 N
EXCLK C2 P	EXCLK C2 P
EXCLK C2 N	EXCLK C2 N

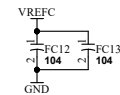
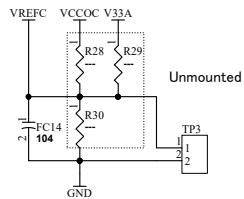
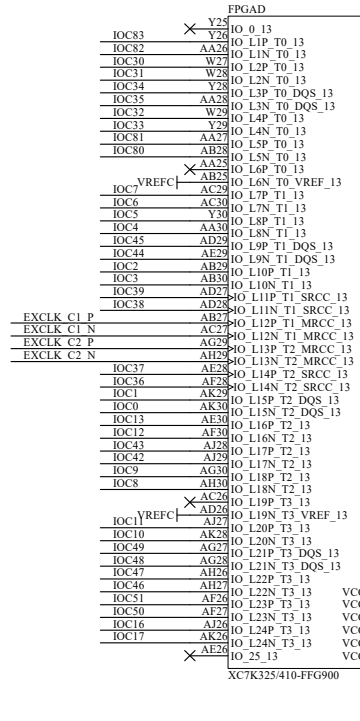
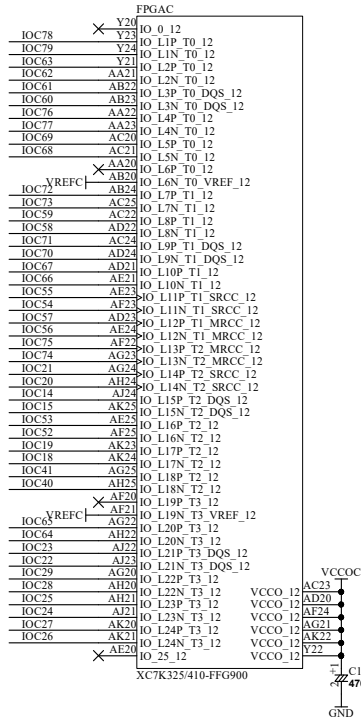

XCM0209R2-SCH-B1.pdf

HUMAN DATA
HuMANDATA LTD.
www.hdl.co.jp

DSN:	TITLE: KINTEX-7 FFG900 FPGA Board
DOC. No:	XCM-209
FILE: IOC.SchDoc	DATE: 2020/03/09 9:46:38
Sheet: 5 / 8	B1

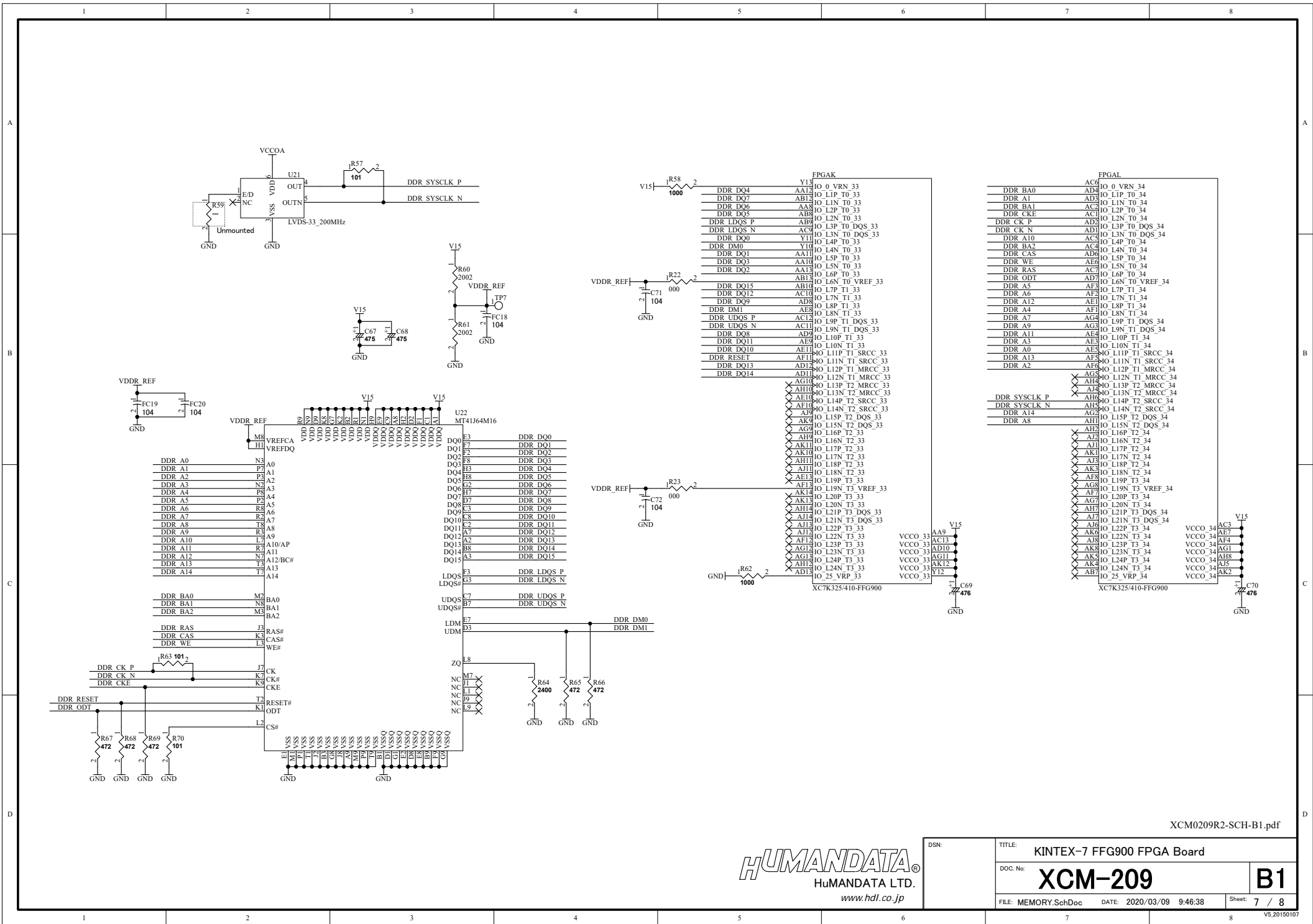

XCM0209R2-SCH-B1.pdf



DSN:	TITLE: KINTEX-7 FFG900 FPGA Board	B1
DOC. No:	XCM-209	
FILE: MEMORY.SchDoc	DATE: 2020/03/09 9:46:38	Sheet: 7 / 8

