

1 2 3 4 5 6 7 8

A

A

View from Top side (Scale 2:1)

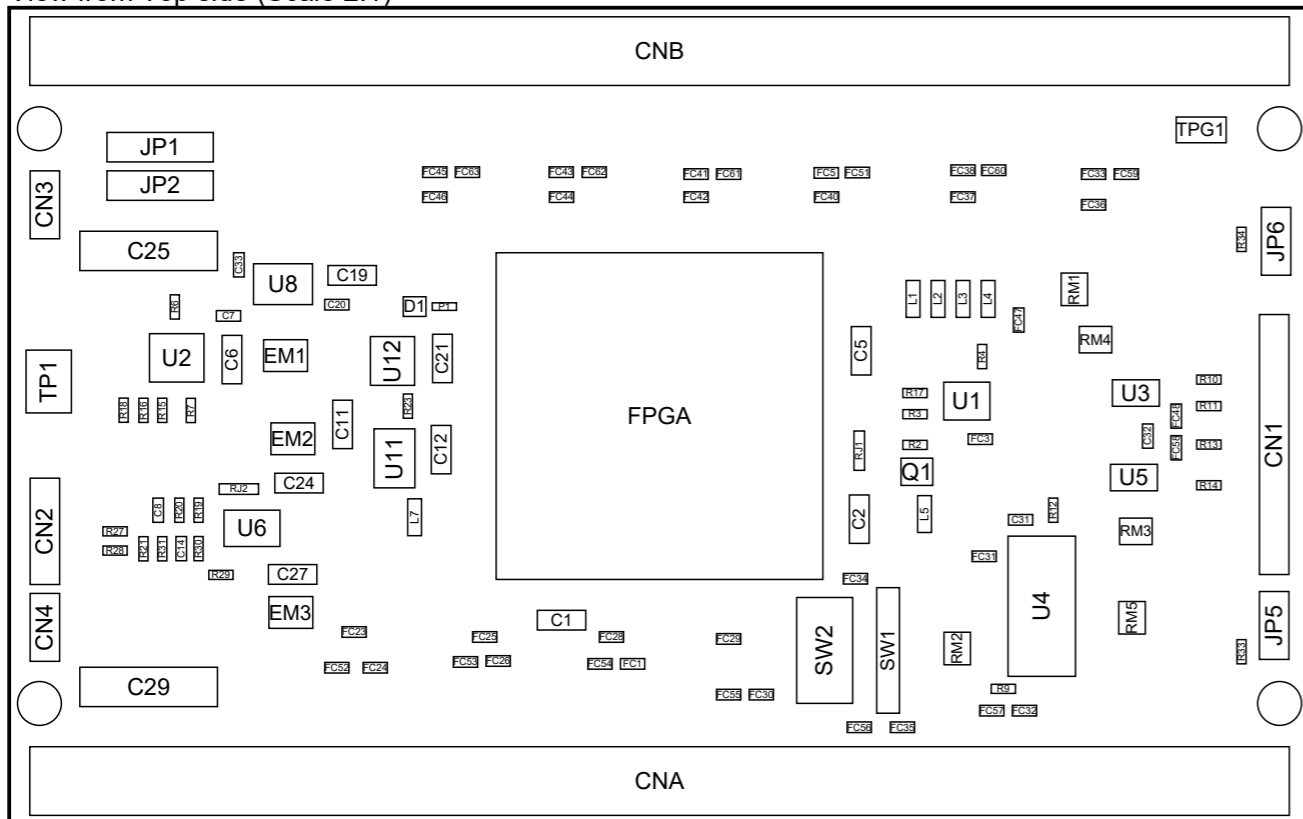

B

B

View from Bottom side (Scale 2:1)

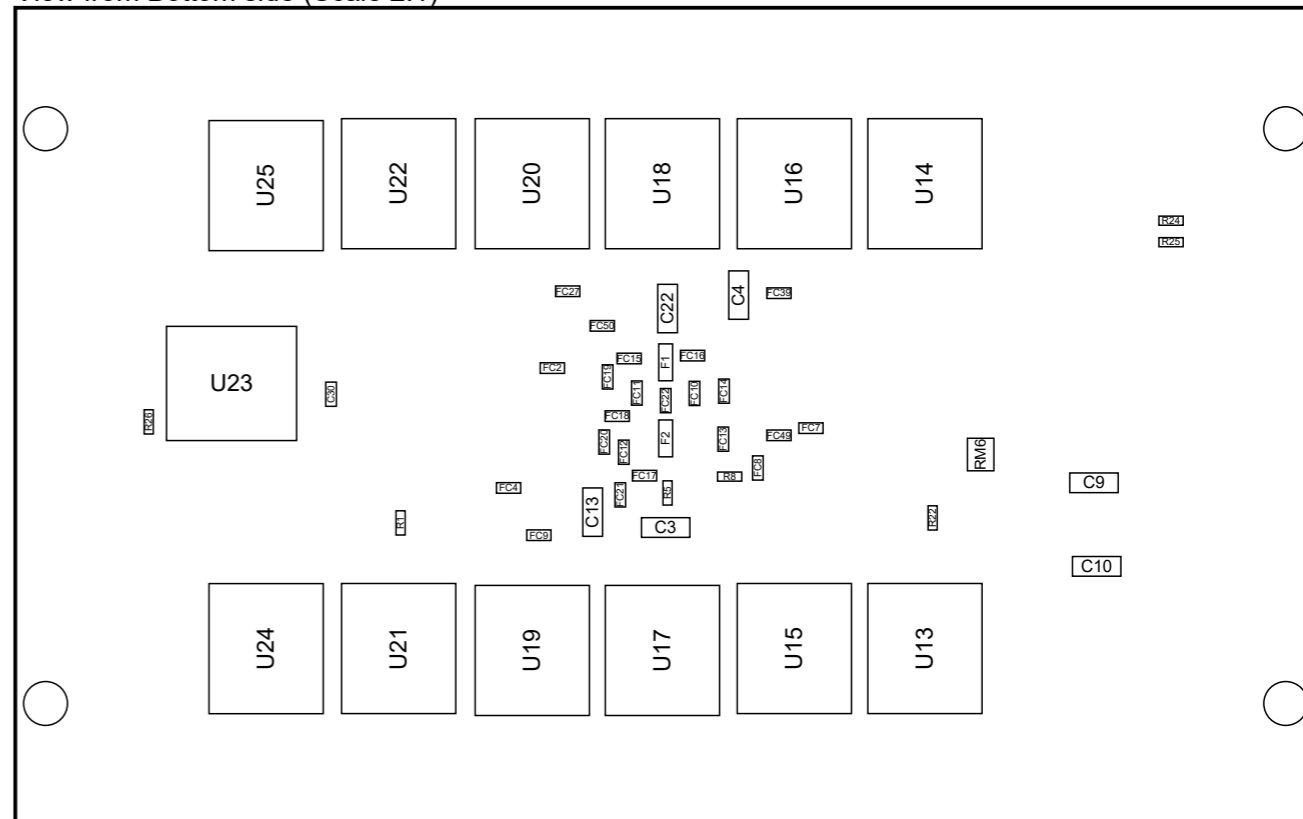

C

C

PCB Version : C

D

D



HuMANDATA LTD.
www.hdl.co.jp/ (Japan)
www2.hdl.co.jp/en/ (Global)

DSN	TITLE: XCM-026C PCB Drawing	
	DOC.No: XCM026LR2-PCB-C	REV B
	FILE:	DATE: 2022/09/06 Sheet: 1 / 2

1 2 3 4 5 6 7 8

1 2 3 4 5 6 7 8

A

A

TopLayer (Scale 1:1)

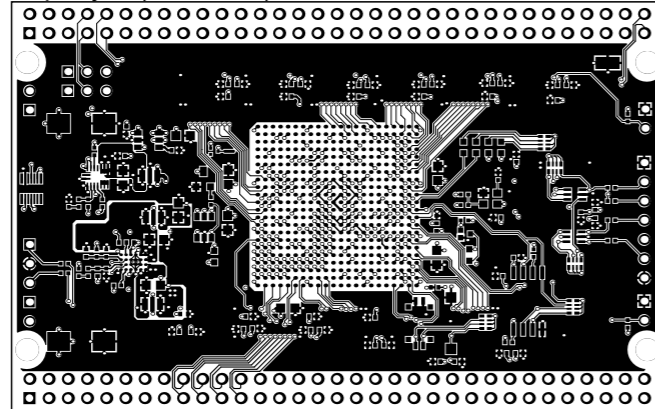

MidLayer1 (Scale 1:1)

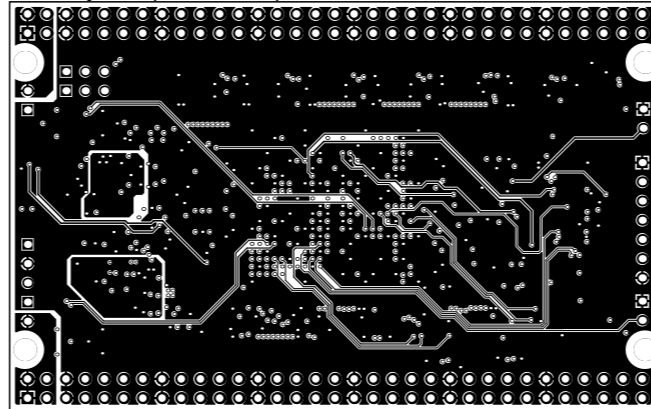

InternalPlane2 (Scale 1:1)

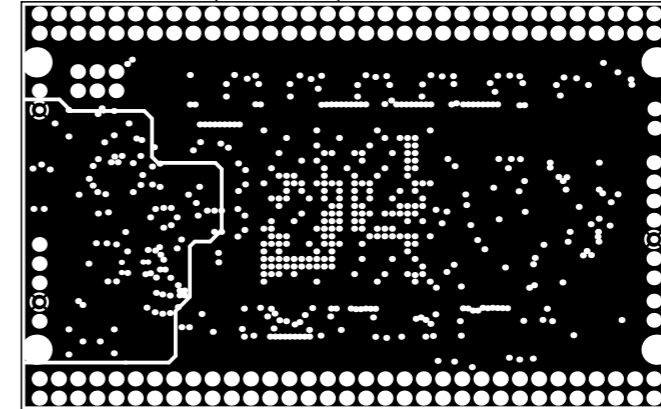

B

B

InternalPlane1 (Scale 1:1)

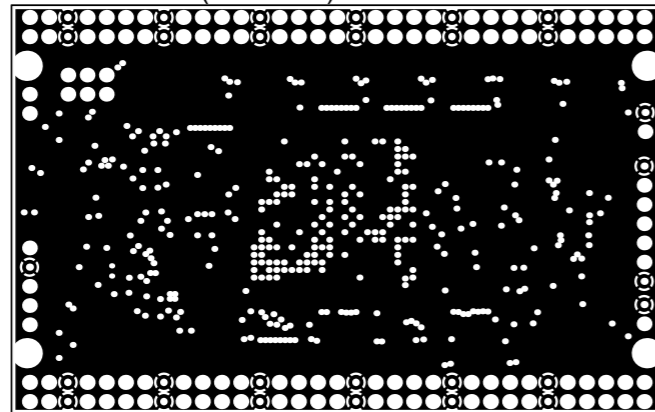

MidLayer2 (Scale 1:1)

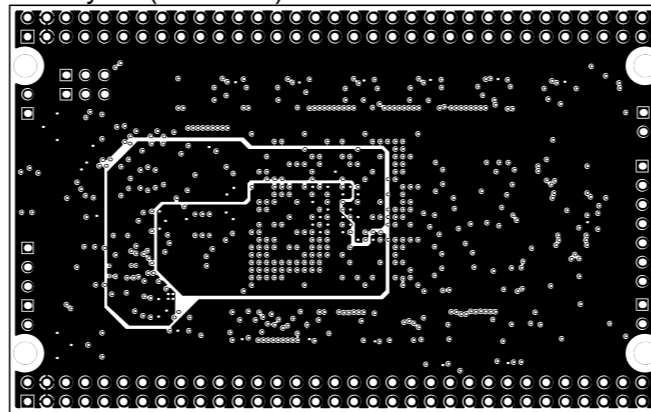

BottomLayer (Scale 1:1)

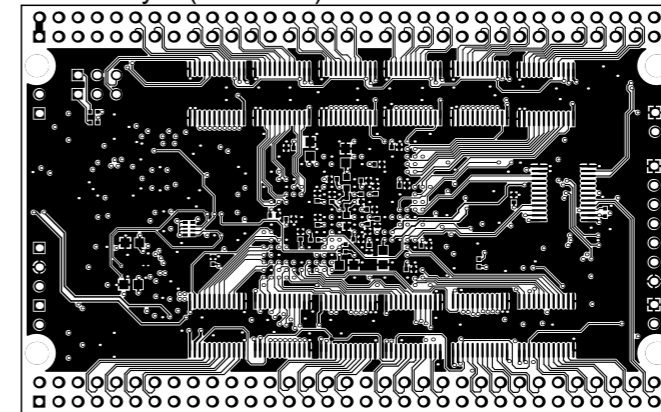

C

C

PCB Version : C

D

D



HuMANDATA LTD.
www.hdl.co.jp/ (Japan)
www2.hdl.co.jp/en/ (Global)

DSN

TITLE:

XCM-026C PCB Drawing

DOC.No:

XCM026LR2-PCB-C

REV

B

FILE:

DATE: 2022/09/06

Sheet: 2 / 2

1 2 3 4 5 6 7 8

V2_20210721