

V33A	V33A
VIOB	VIOB
VCCINT_10	VCCINT_10
VMGTVCC_10	VMGTVCC_10
VMGTAVTT_12	VMGTAVTT_12
VMGTAVCCAUX_18	VMGTAVCCAUX_18
VCCAUX_18	VCCAUX_18
VCCXADC_18	VCCXADC_18
VCCOA	VCCOA
VCCOB	VCCOB
GND	GND

Power sense point

1	GND
2	VCCINT_10
3	VMGTVCC_10
4	VMGTAVTT_12
5	VCCAUX_18
6	VMGTAVCCAUX_18
7	VCCXADC_18
8	VCCOB
9	VDDR
10	VCCOA

[POWER]

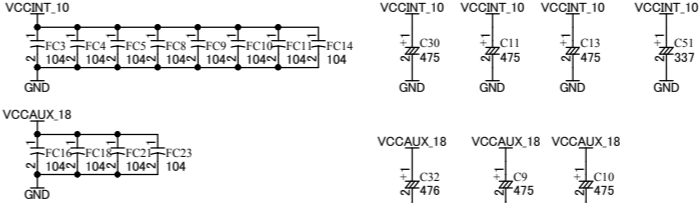
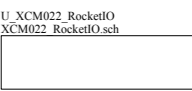
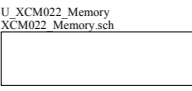
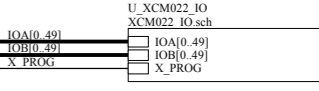
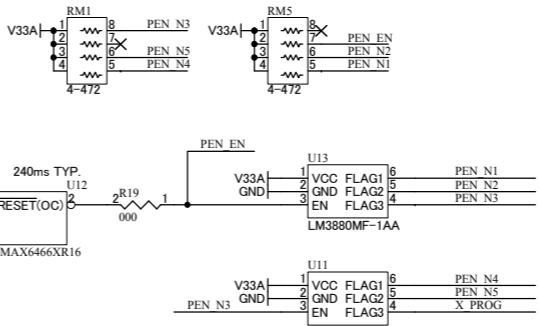
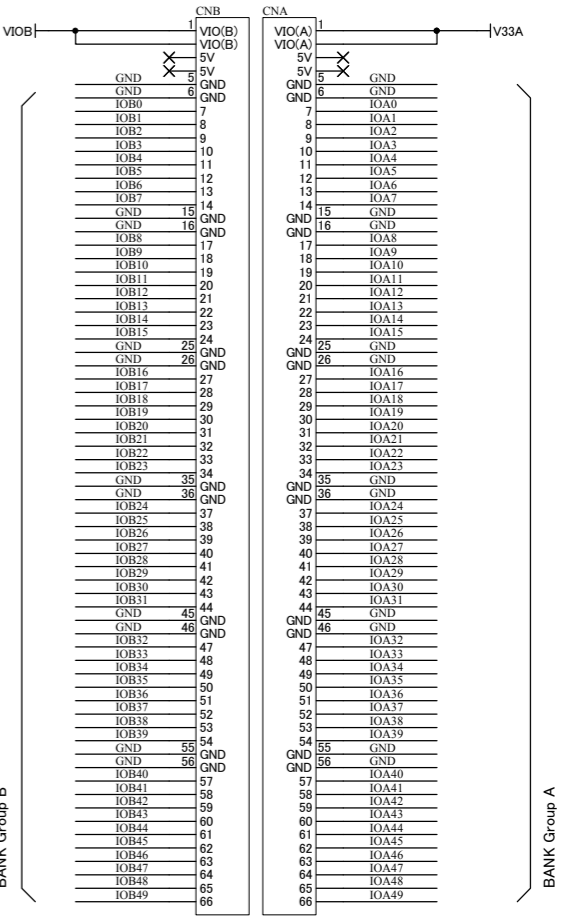
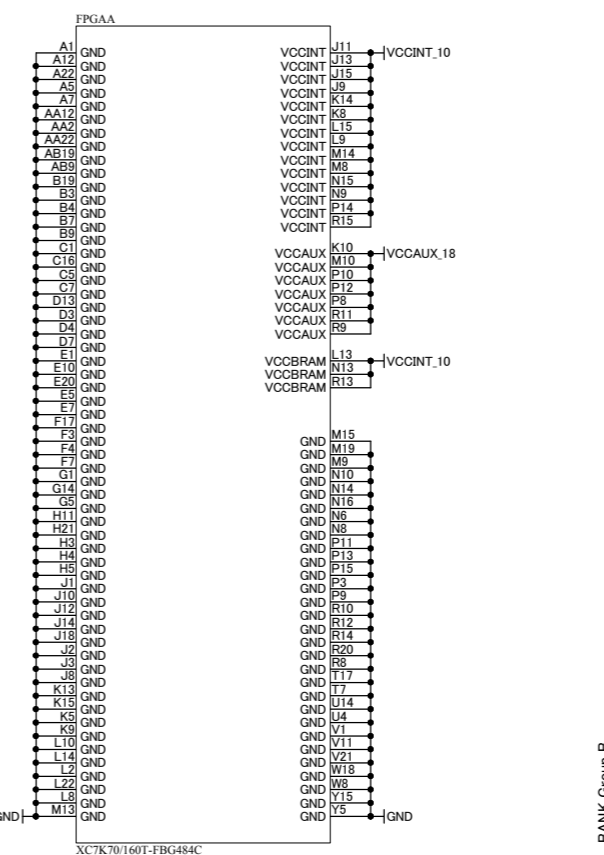
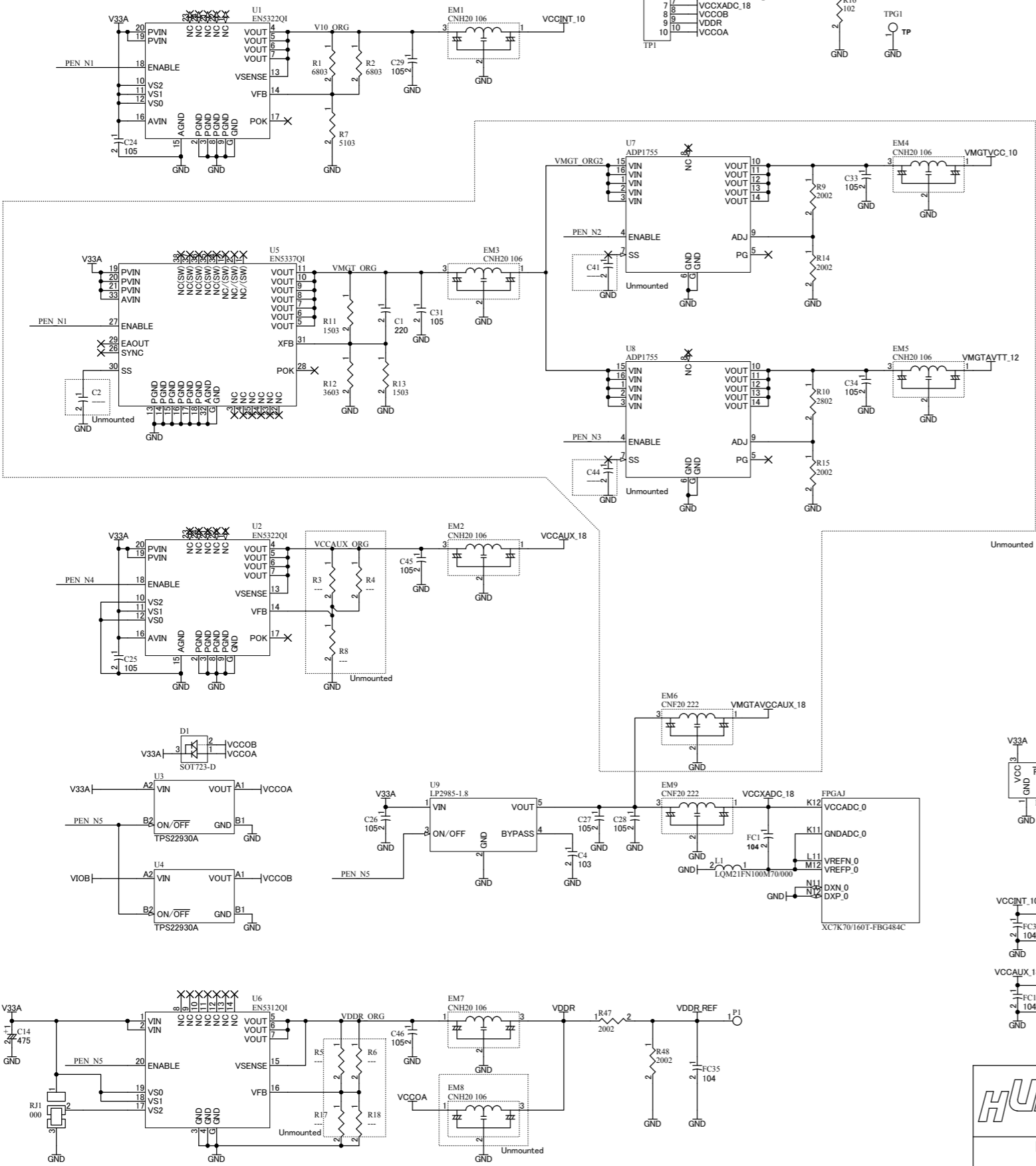
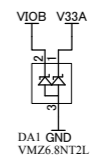

XCM022WR1-SCH-D.pdf

		KINTEX FBG484 FPGA Board	
Date: 2013/10/11	14:01:09	File: XCM022D.sch	Sheet 1 of 4

V33A	V33A
VIOB	VIOB
VCCINT_10	VCCINT_10
VMGTVCC_10	VMGTVCC_10
VMGTAVTT_12	VMGTAVTT_12
VMGTAVCGAUX_18	VMGTAVCGAUX_18
VCCAUX_18	VCCAUX_18
VCCXADC_18	VCCXADC_18
VCCOA	VCCOA
VCCOB	VCCOB
GND	GND

BANK Group B

BANK Group A

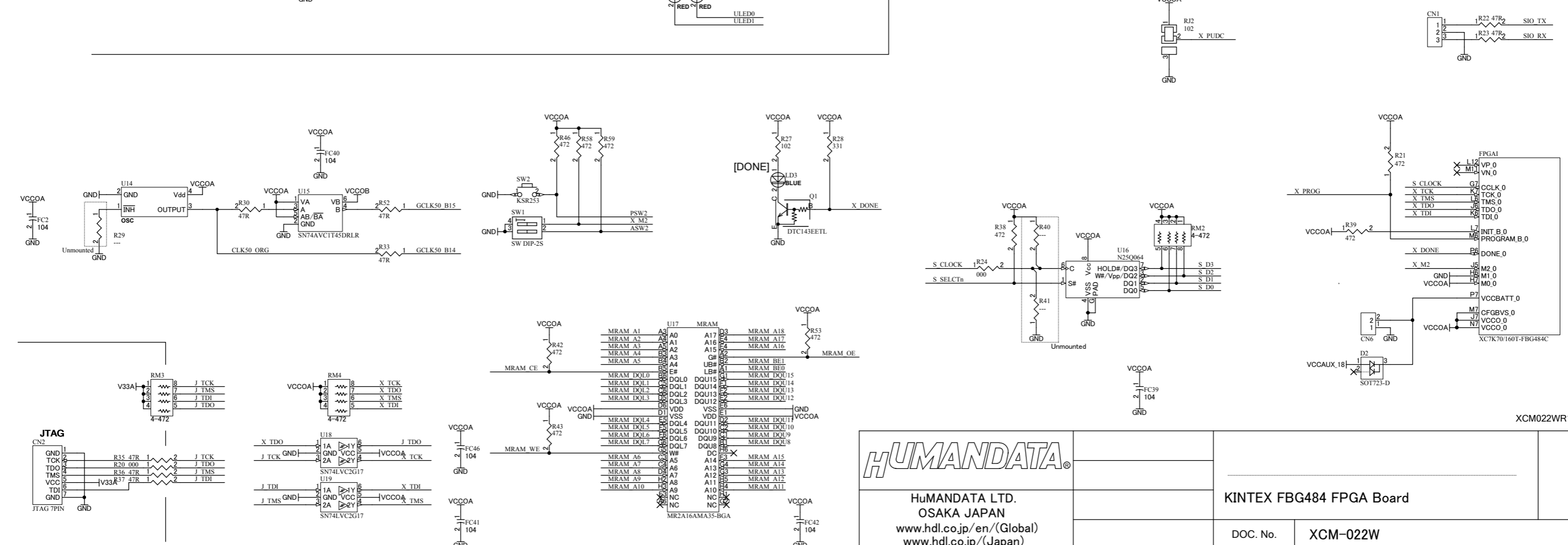
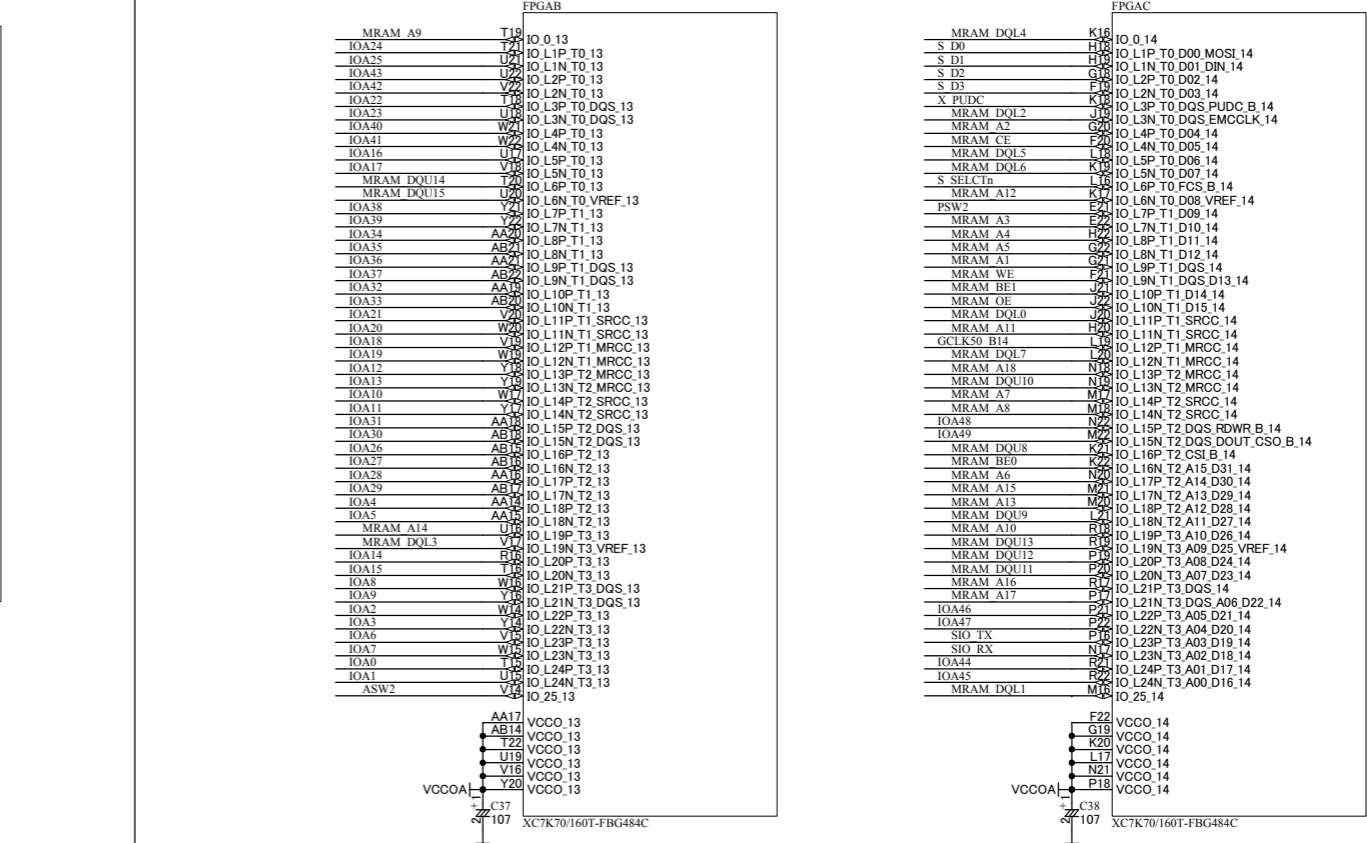
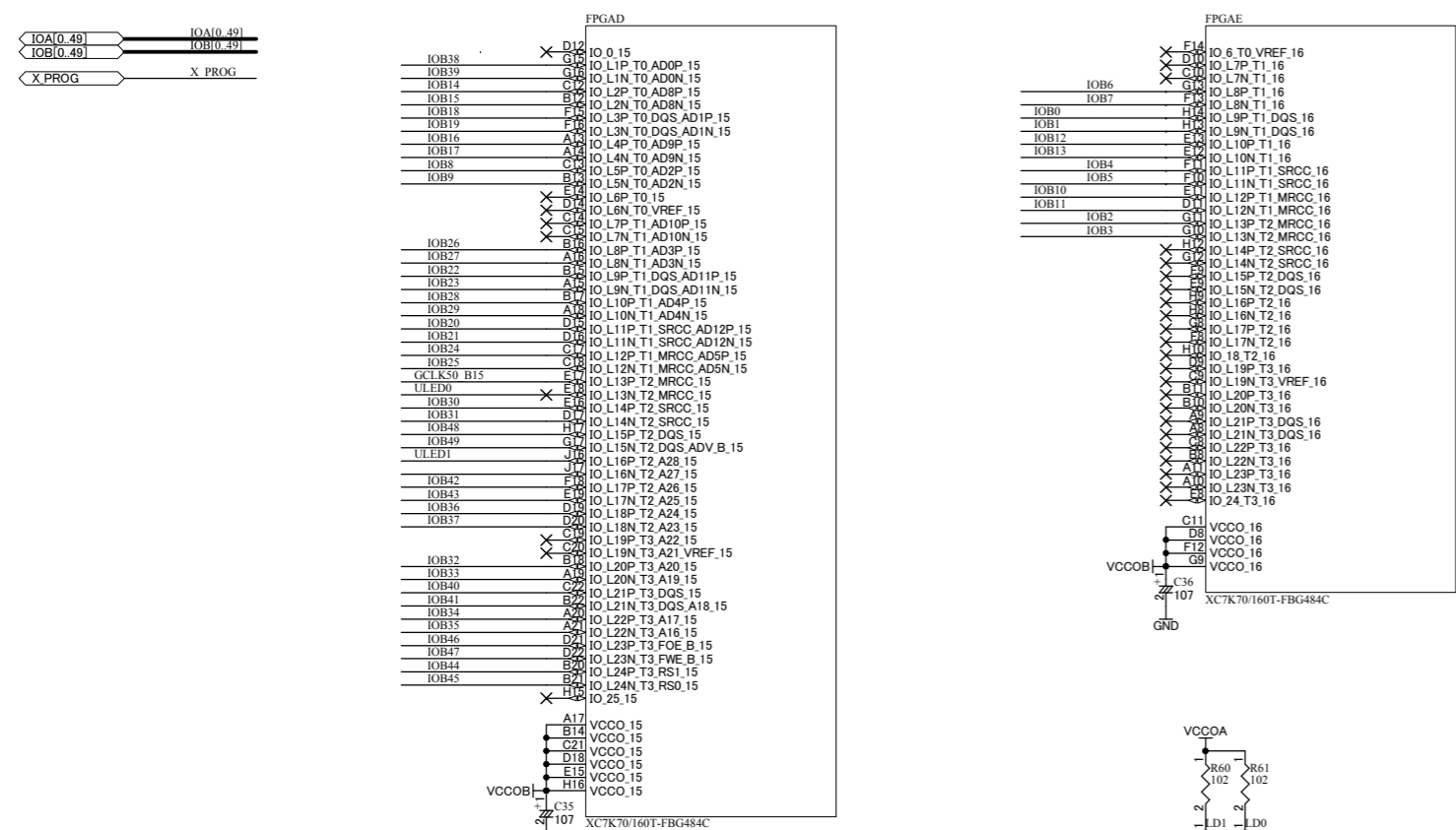

HUMAN DATA LTD.
OSAKA JAPAN
www.hdl.co.jp/en/(Global)
www.hdl.co.jp/(Japan)

KINTEX FBG484 FPGA Board

Date:	2013/10/11	14:01:09	File:	XCM022_IO.sch	Sheet 2 of 4
				DOC. No. XCM-022W	D

V33A	V33A
VIOB	VIOB
VCCINT_10	VCCINT_10
VMGTAVCC_10	VMGTAVCC_10
VMGTAVTT_12	VMGTAVTT_12
VMGTAVCCAUX_18	VMGTAVCCAUX_18
VCCAUX_18	VCCAUX_18
VCCXADC_18	VCCXADC_18
VCCOA	VCCOA
VCCOB	VCCOB
GND	GND

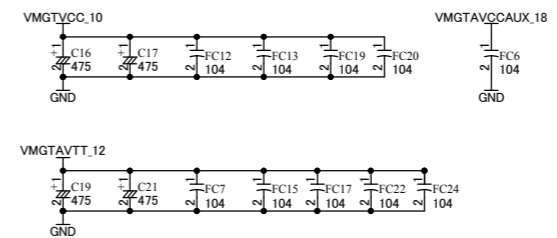
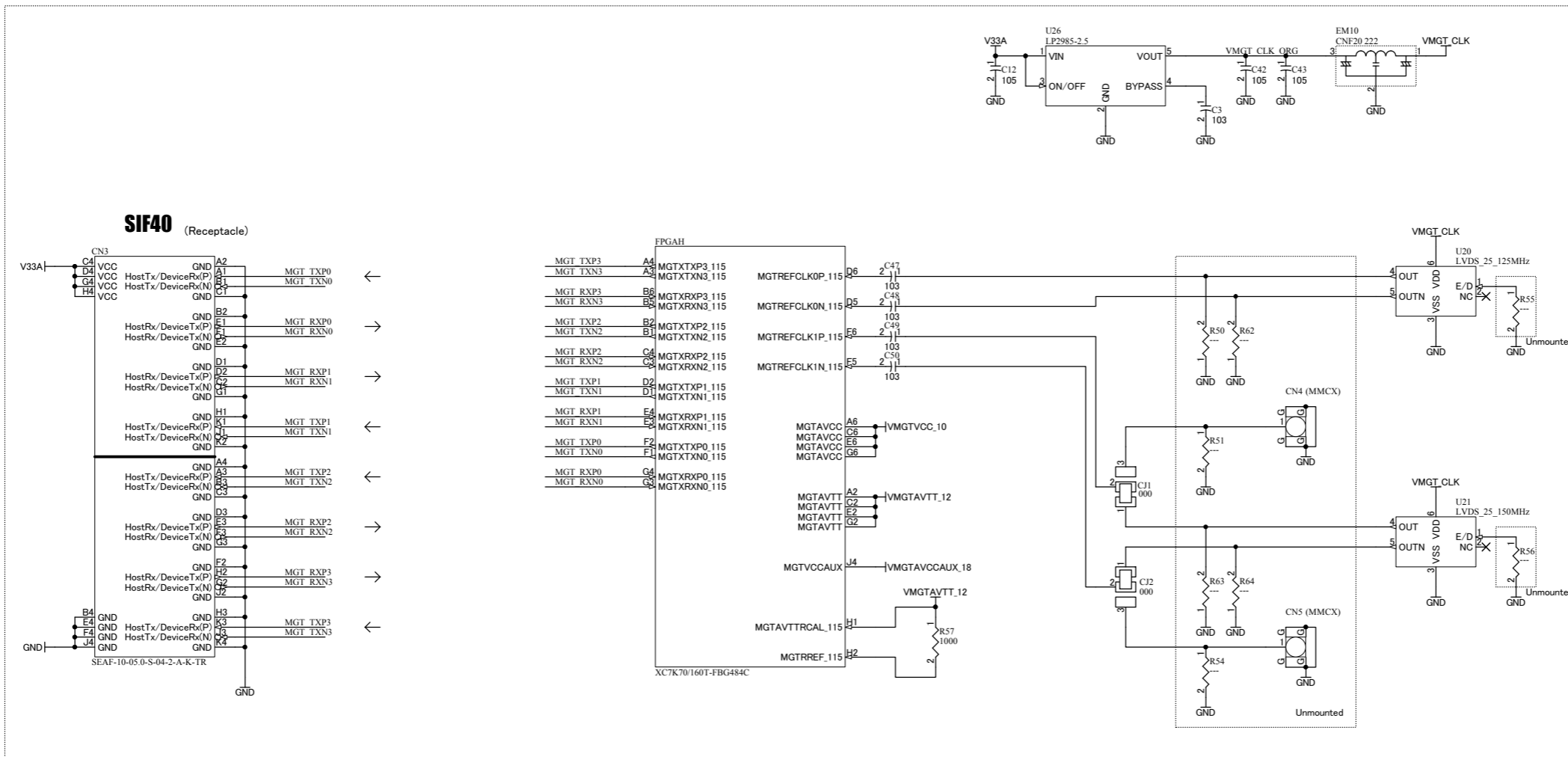

		KINTEX FBG484 FPGA Board		
				HuMANDATA LTD. OSAKA JAPAN www.hdl.co.jp/en/(Global) www.hdl.co.jp/(Japan)
Date: 2013/10/11	14:01:09	File: XCM022_RocketIO.sch	Sheet 4 of 4	D