

V12	V12
V33A	V33A
VIO(B)	VIO(B)
VRFB	VREFA
VRFB	VREFB
GND	GND

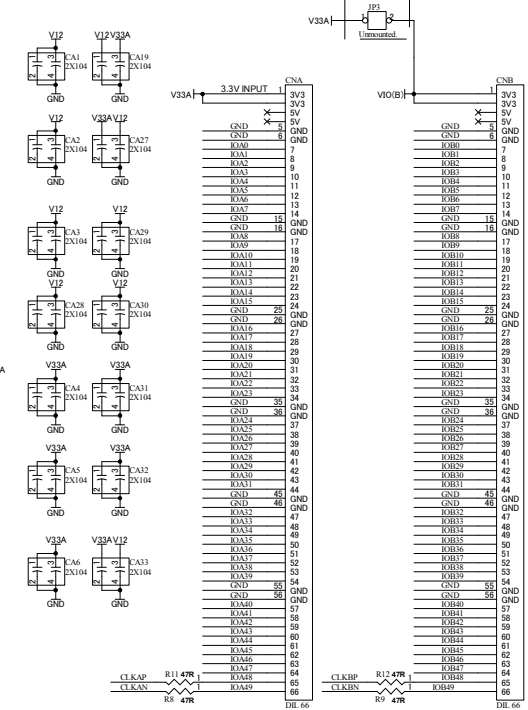
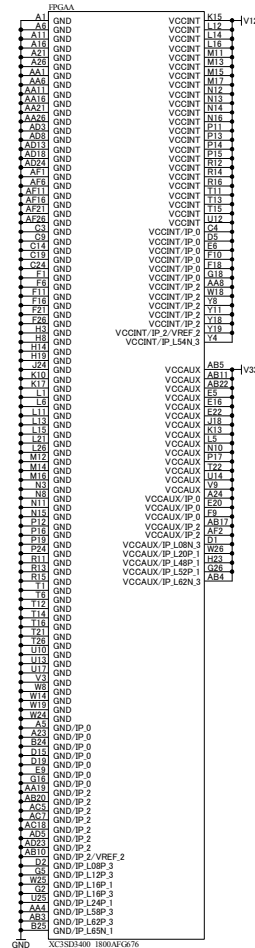
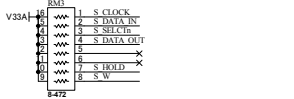
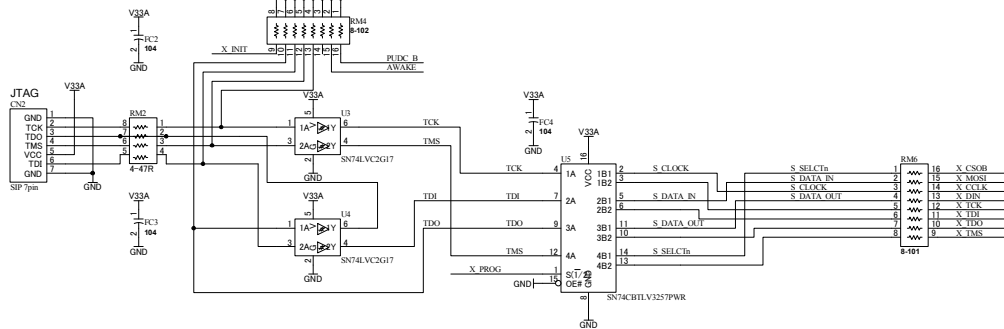
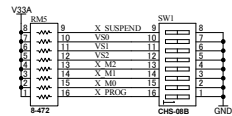
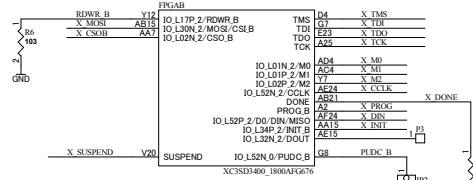
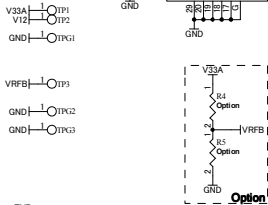
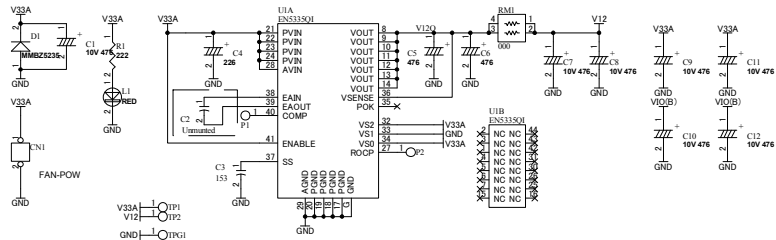

XC93S400-1800AFG676

HUMAN DATA LTD.
OSAKA JAPAN
www.hdl.co.jp/en/(Global)
www.hdl.co.jp/(Japan)

Xilinx Spartan-3A DSP FGG676 FPGA board

Date:	31-May-2013	16:39:19	File:	XCM016A.sch	Sheet 1 of 2
DOC. No.	XCM-016		A3		

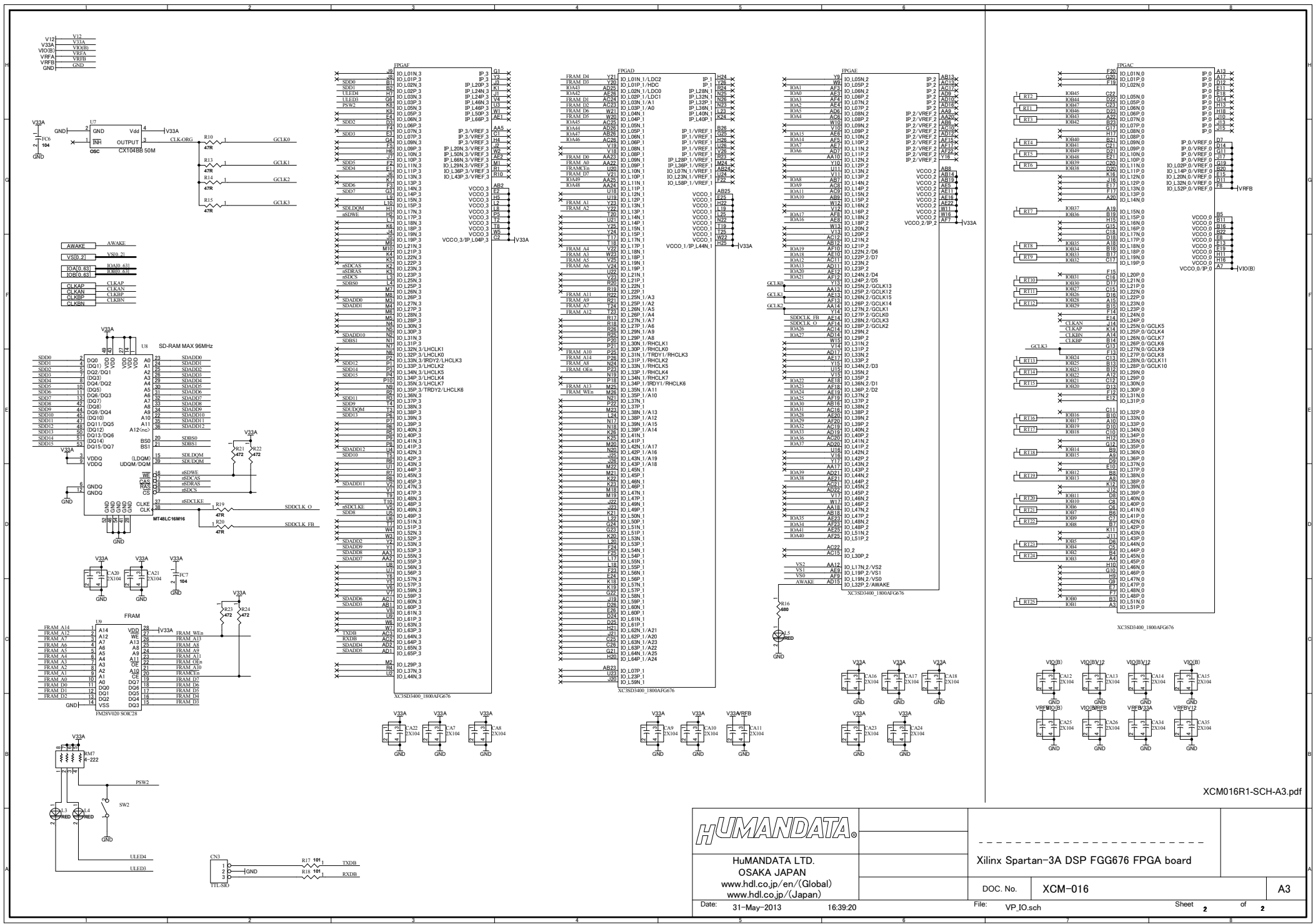

HUMAN DATA
HuMANDATA LTD.
OSAKA JAPAN
www.hdl.co.jp/en/(Global)
www.hdl.co.jp/(Japan)

Xilinx Spartan-3A DSP FGG676 FPGA board

DOC. No.	XCM-016	A3
Date:	31-May-2013	16:39:20
File:	VP_IO.sch	Sheet 2 of 2