

TOP LAYER

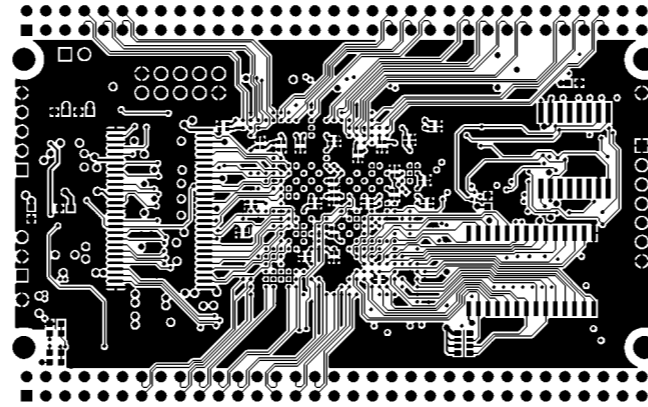

MID LAYER 2

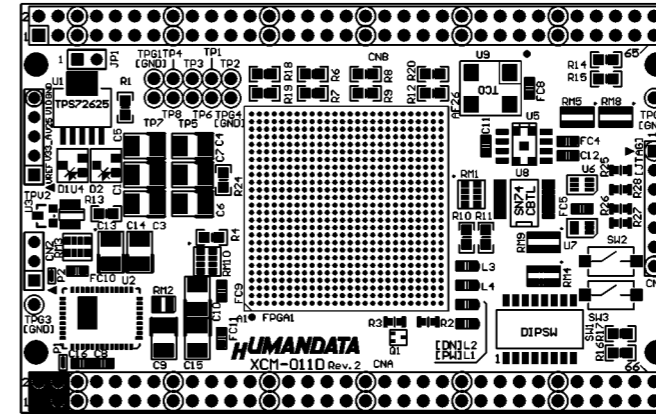

Component Side

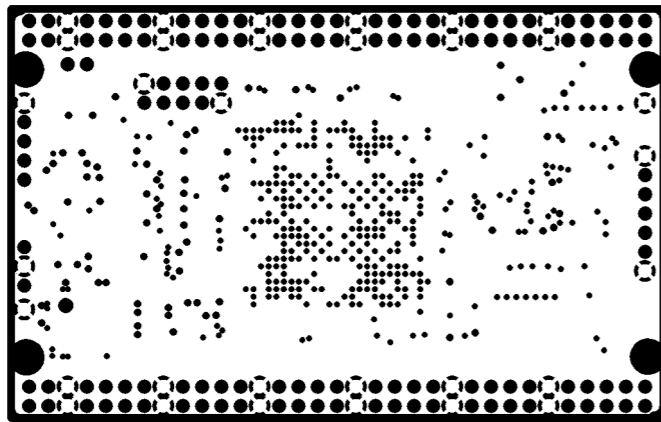

INTERNAL PLANE 1

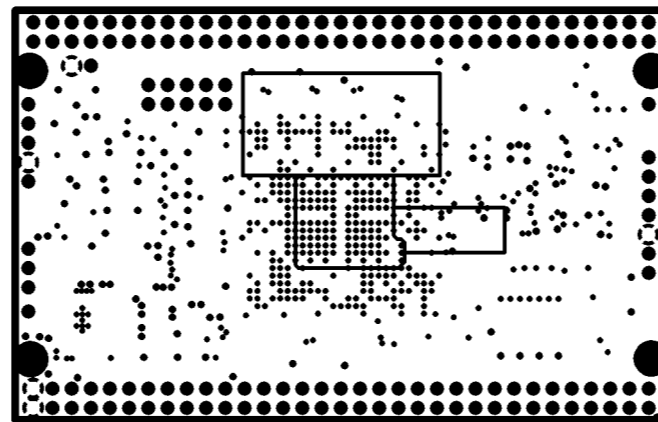

INTERNAL PLANE 2

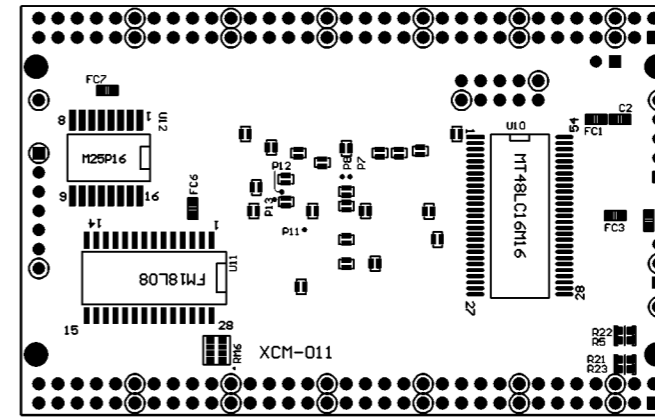

Solder Side

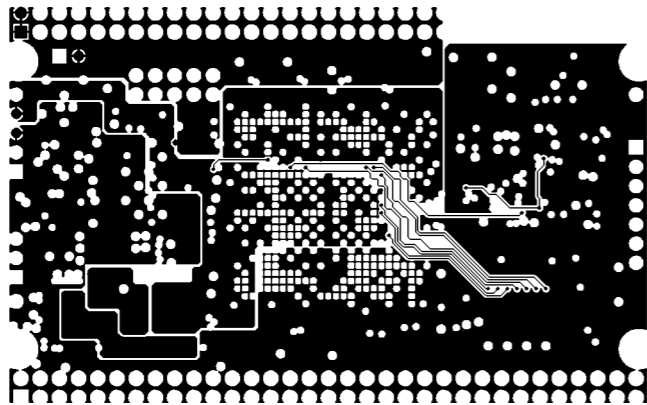

MID LAYER 1

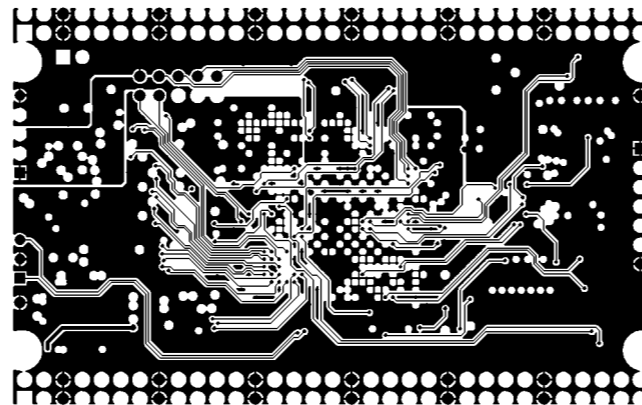

BOTTOM LAYER

HUMANDATA		UNIT	TITLE	
CHK	DWG		XCM-011D PCB drawing	
		SIZE	DWG NO	REV
			PCB-XCM-011D	C

