

V12  
V25  
V33\_A  
V50  
GND

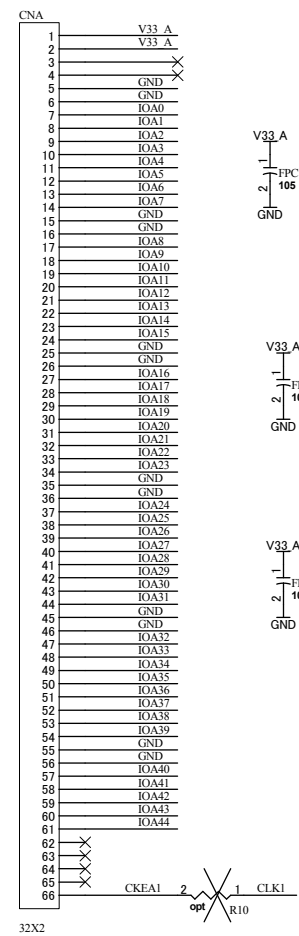

BANKA  
BANKB

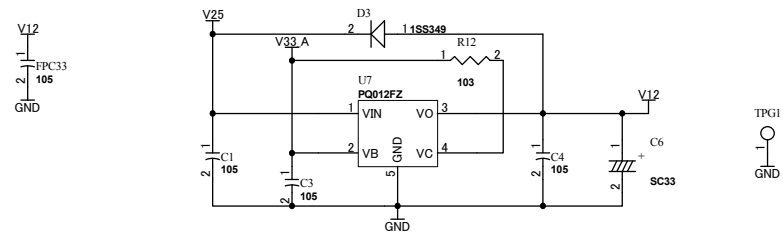
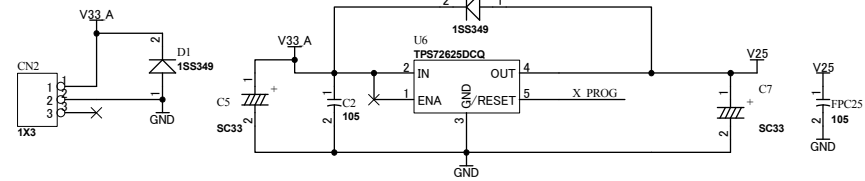
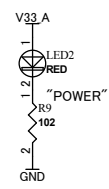
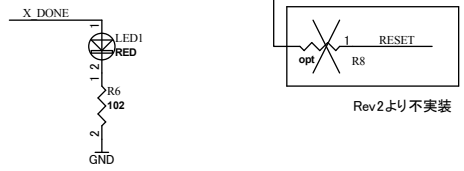
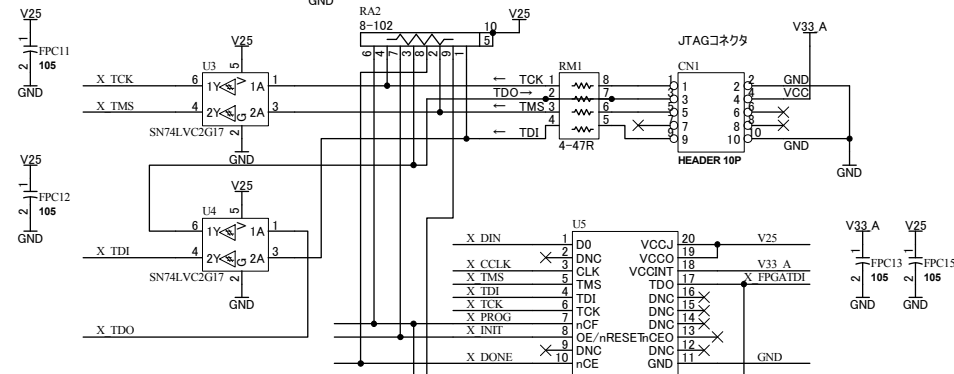
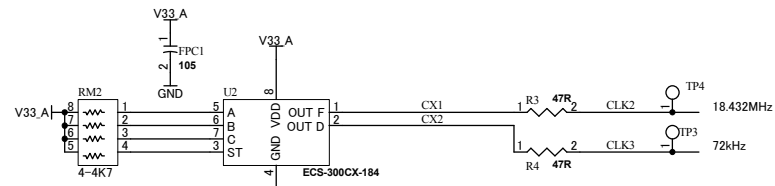
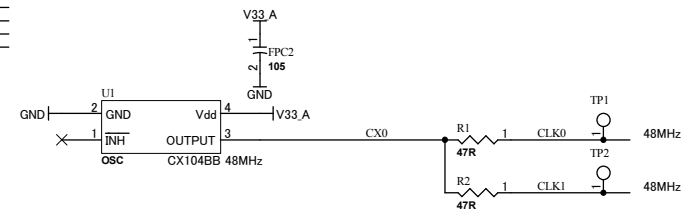
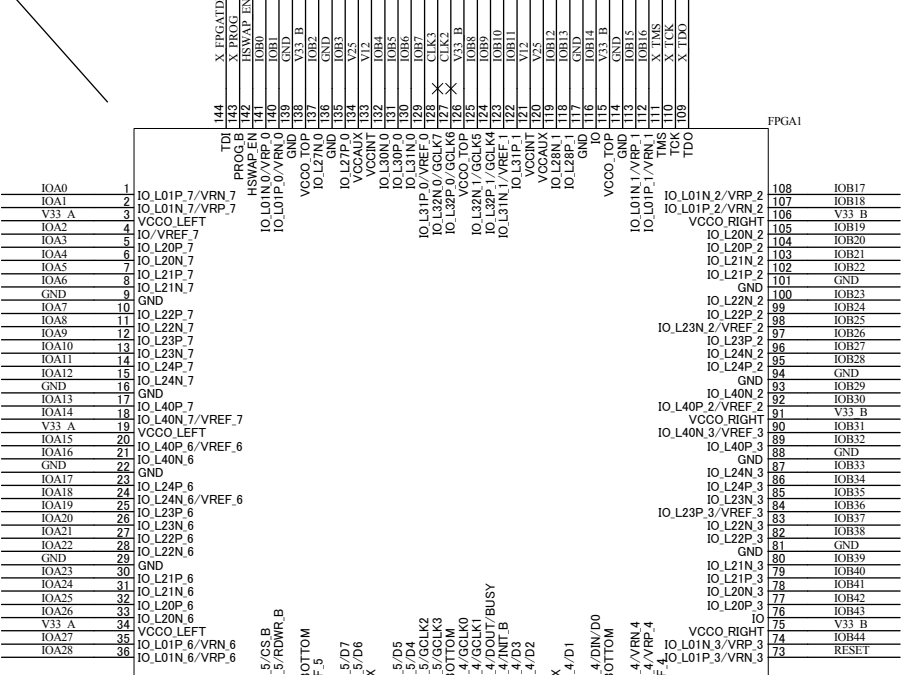
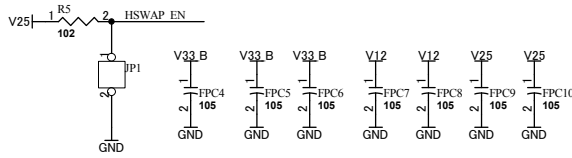

BANKA  
BANKB

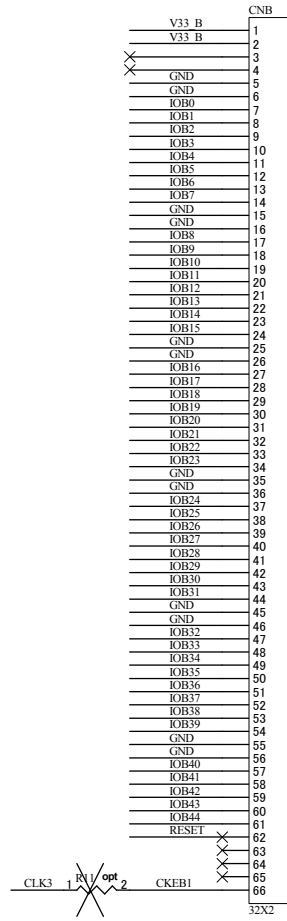
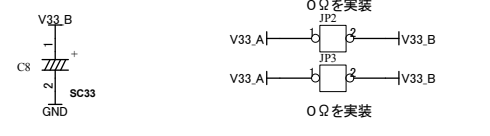

Rev2

		2007/12/14	
		SP3 TQ144 FPGA BOARD	
HuMANDATA LTD. OSAKA JAPAN www.hdl.co.jp		DOC. No.	XCM-008
Date: 14-Dec-2007	15:34:42	File: XCM008B.sch	Sheet 1 of 1