

V12 V25
 V33_A V33_A
 V50 V50
 GND GND

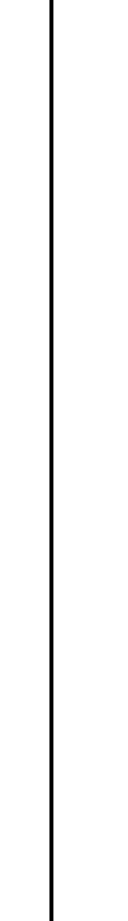

注) CLK1がCLOCKピンに接続されていません

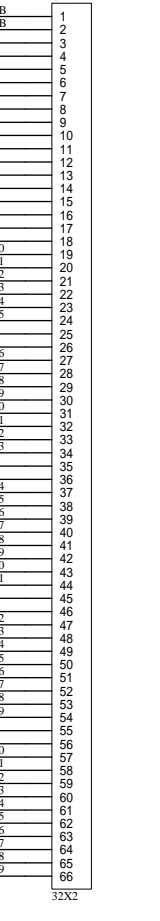
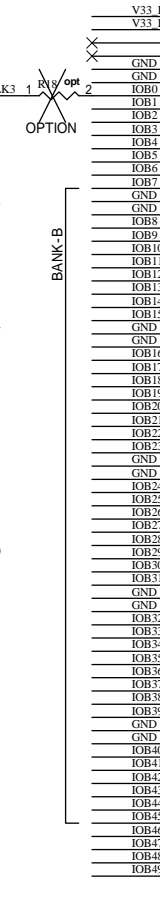
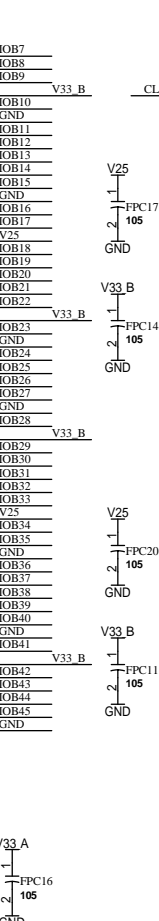
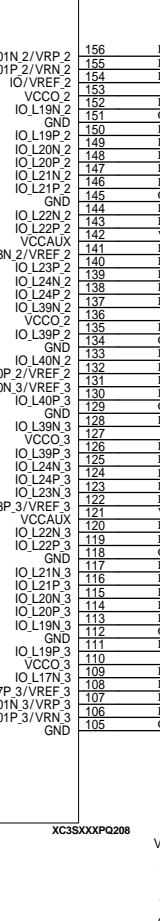
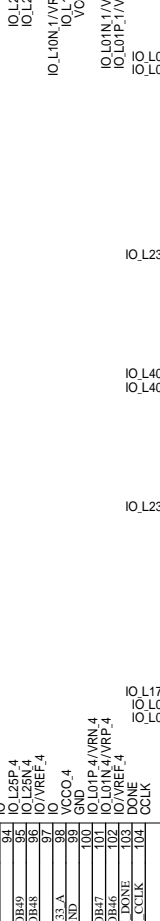
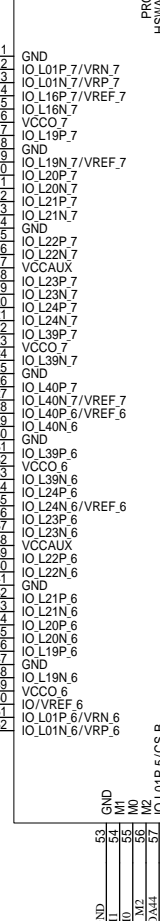
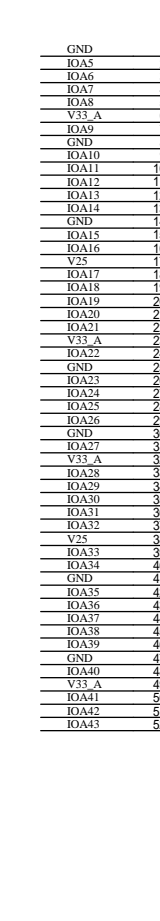
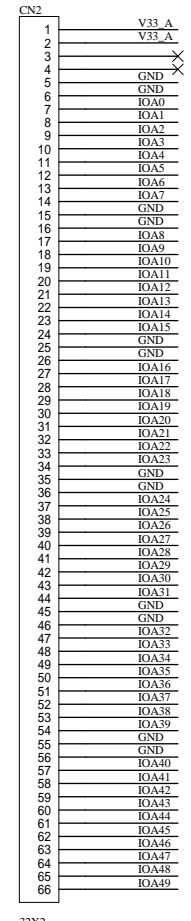
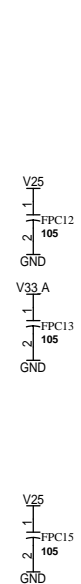
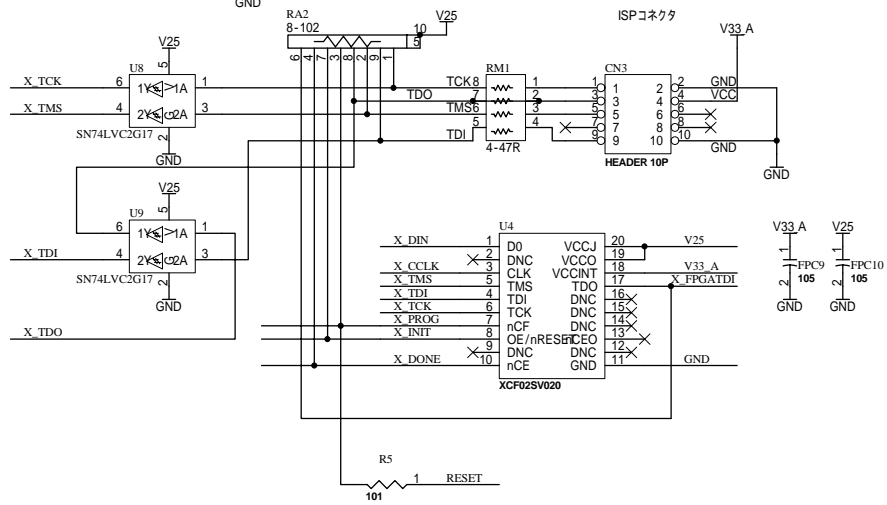
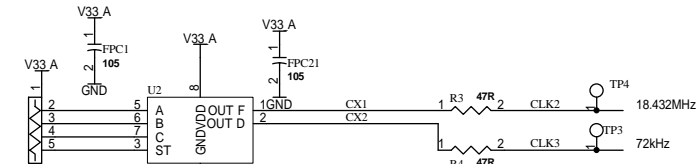
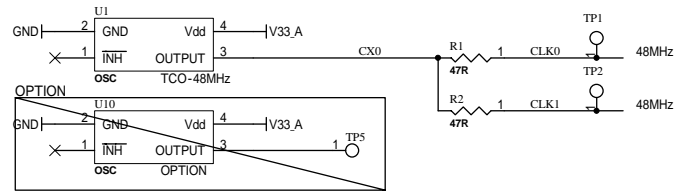
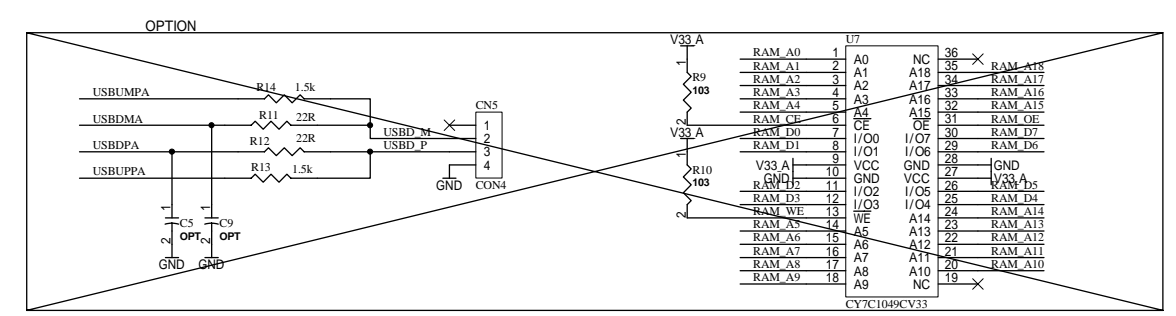

		2006/02/02	
		HuMANDATA LTD. OSAKA JAPAN www.hdl.co.jp	
Date: 2-Feb-2006 15:12:11		SP3 FPGA BOARD	
		DOC. No.	XCM-001
File: XCM001E.sch		Sheet 1 of 1	E2