

A
B
C
D

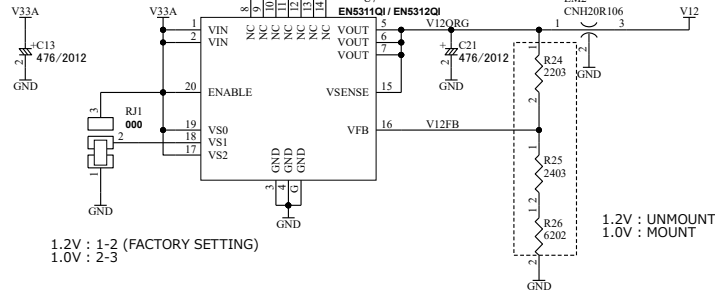

1.2V : 1-2 (FACTORY SETTING)
1.0V : 2-3

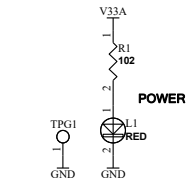
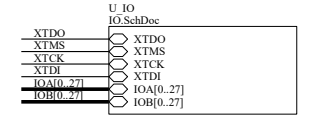
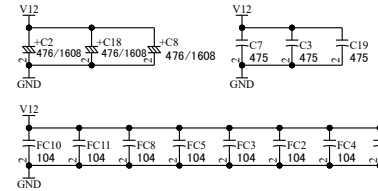
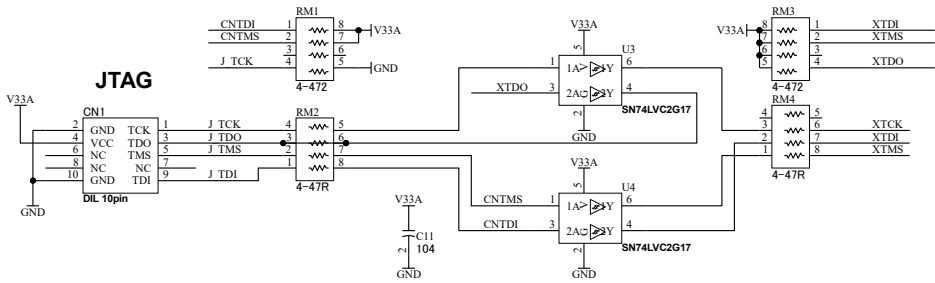
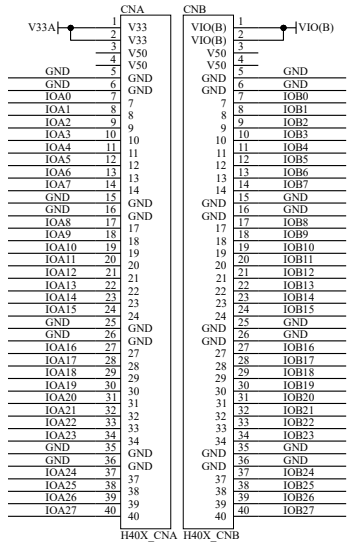
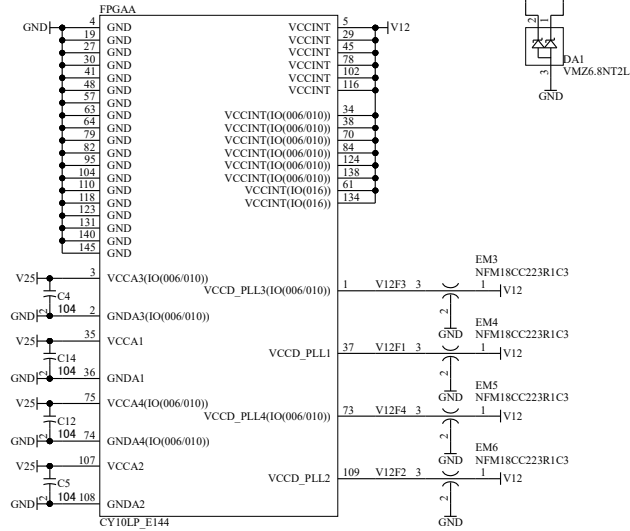
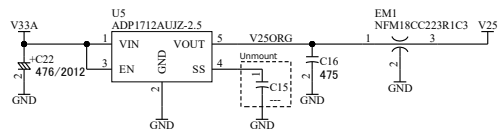

ACM308R2-SCH-B3.pdf

HUMAN DATA
 HUMAN DATA LTD.
[www.hdl.co.jp/ \(Japan\)](http://www.hdl.co.jp/)
[www2.hdl.co.jp/en/ \(Global\)](http://www2.hdl.co.jp/en/ (Global))

DSN:	TITLE: Cyclone 10 LP E144 FPGA Board	B3
DOC. No:	ACM-308	
FILE: ACM308B_SchDoc	DATE: 2023/10/12 10:15:19	Sheet: 1 / 2

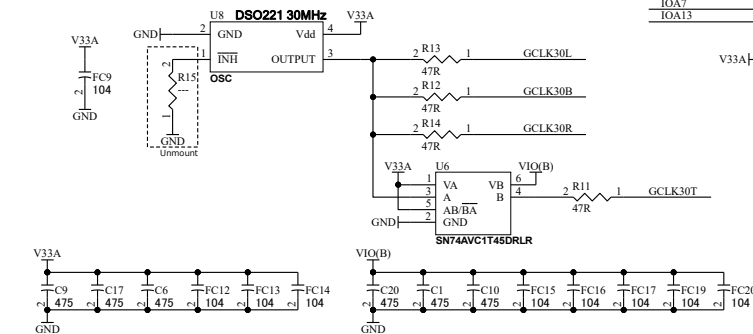
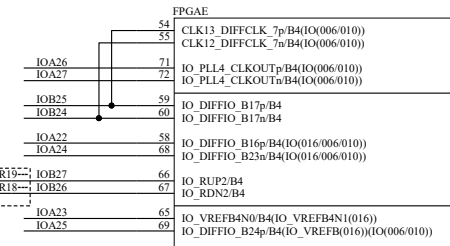
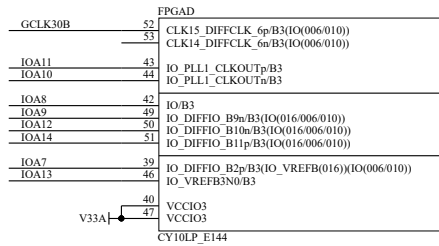
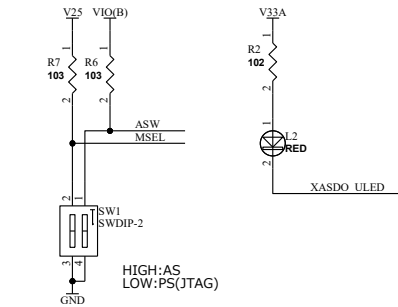
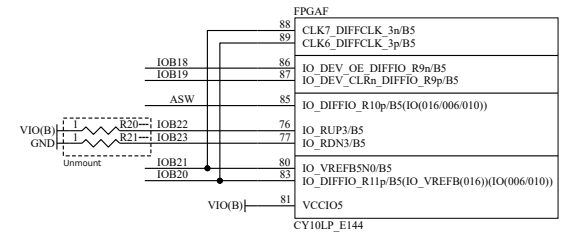
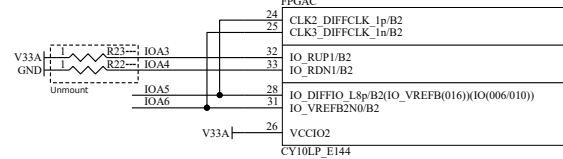
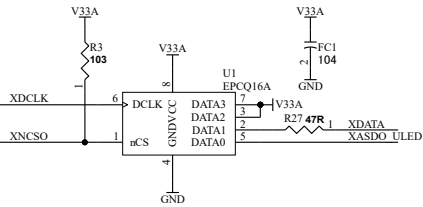
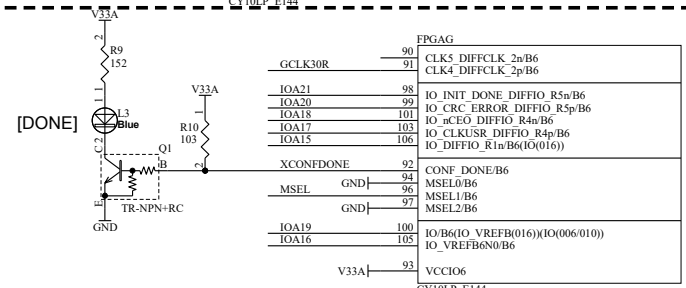
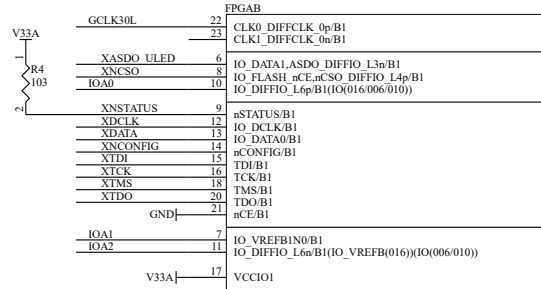
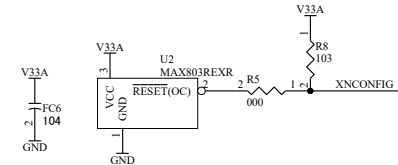
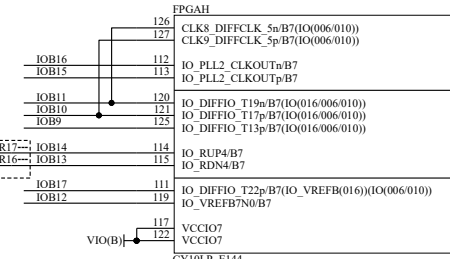
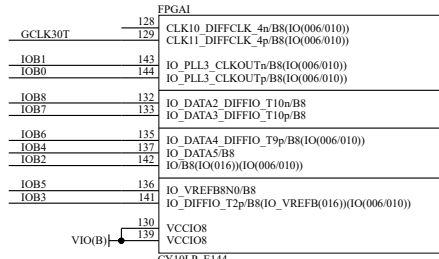
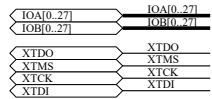

DSN:	TITLE: Cyclone 10 LP E144 FPGA Board
DOC. No:	ACM-308
FILE: IO.SchDoc	DATE: 2023/10/12 10:15:19
Sheet: 2 / 2	B3

ACM308R2-SCH-B3.pdf