

1 2 3 4 5 6 7 8

A

A

B

B

C

C

D

D

View from Top side (Scale 2:1)

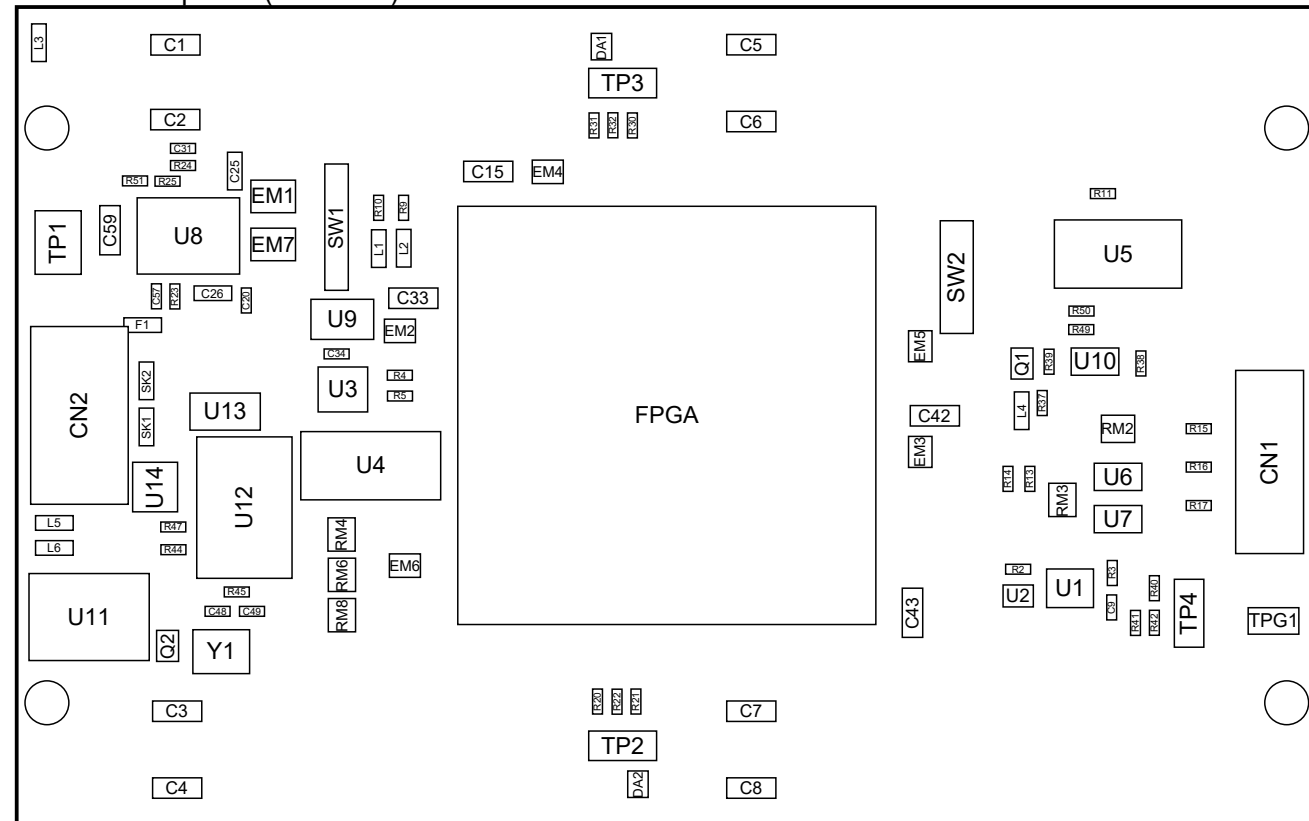

View from Bottom side (Scale 2:1)

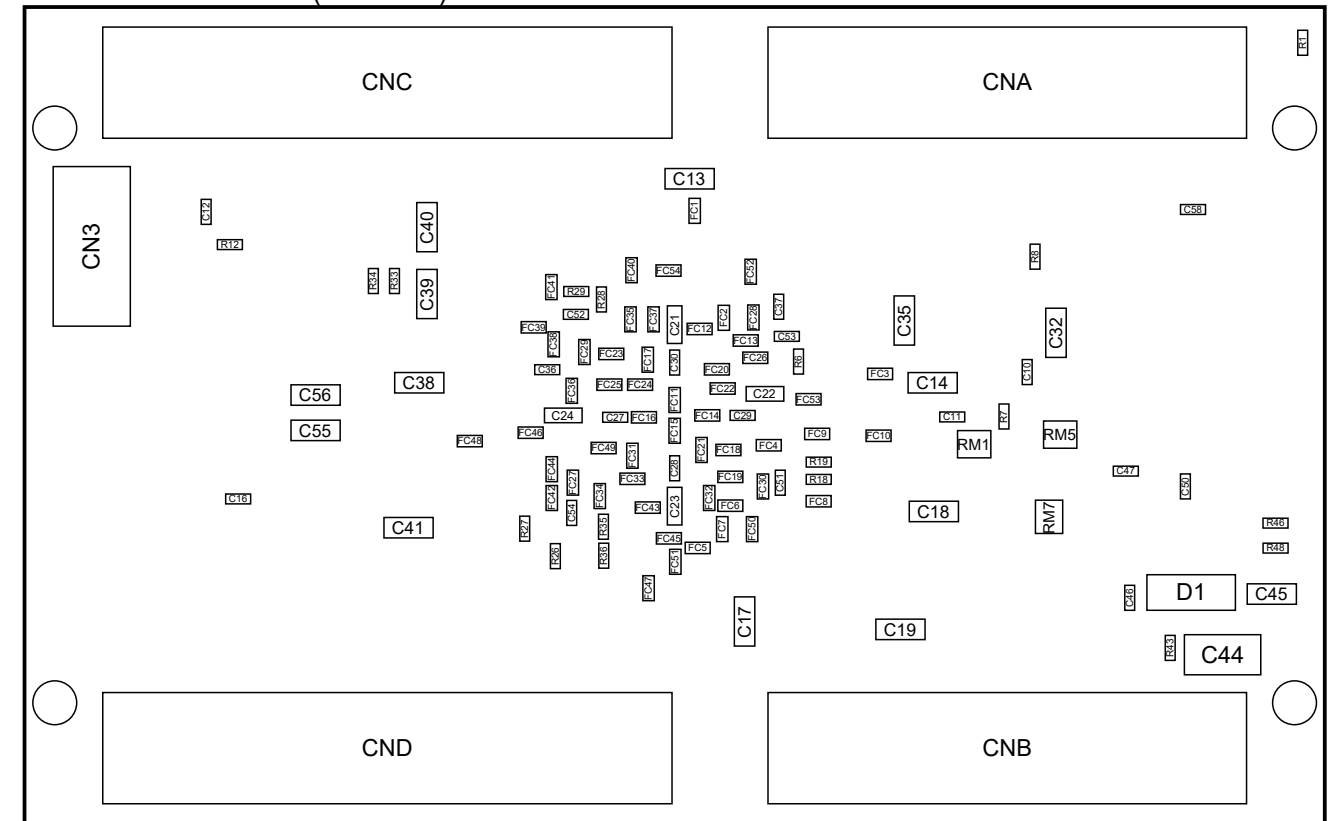

PCB Version : C



HuMANDATA LTD.
www.hdl.co.jp/ (Japan)
www2.hdl.co.jp/en/ (Global)

DSN	TITLE: ACM-208 PCB Drawing	
	DOC.No: PCB-ACM-208	REV B
	FILE:	DATE: 2023/08/10 Sheet: 1 / 2

1 2 3 4 5 6 7 8

1 2 3 4 5 6 7 8

A

TopLayer (Scale 1:1)

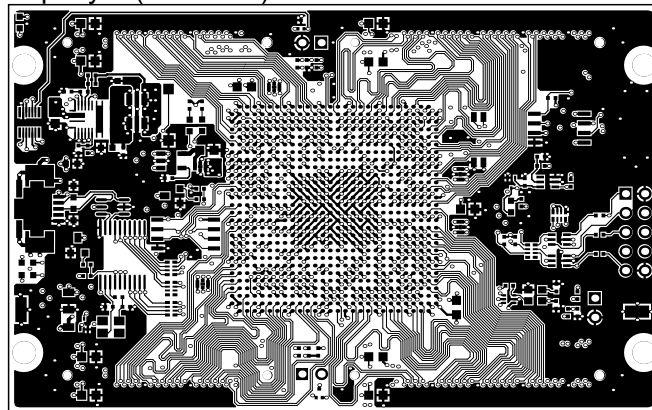

Internal Plane2 (Scale 1:1)

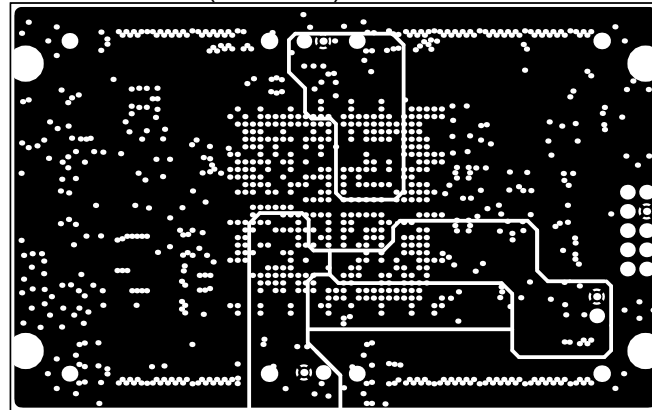

InternalPlane4 (Scale 1:1)

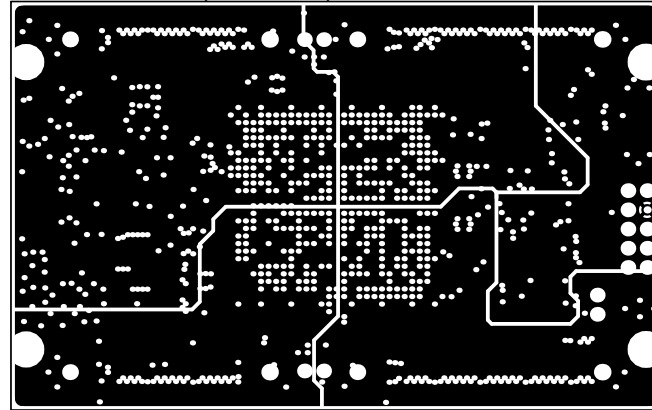

A

B

InternalPlane1 (Scale 1:1)

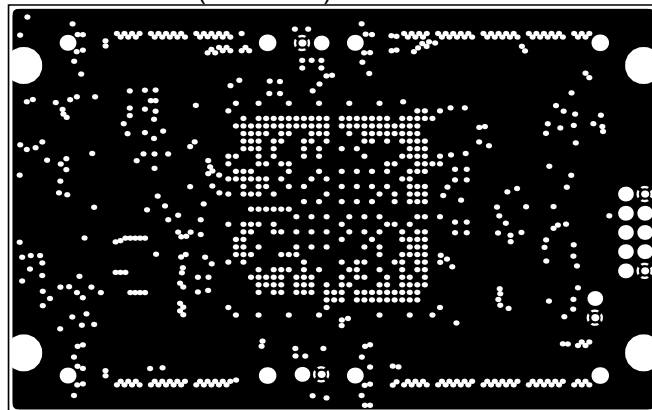

Internal Plane3 (Scale 1:1)

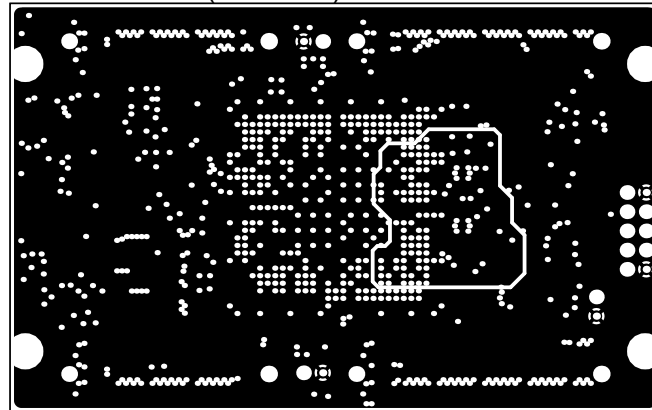

BottomLayer (Scale 1:1)

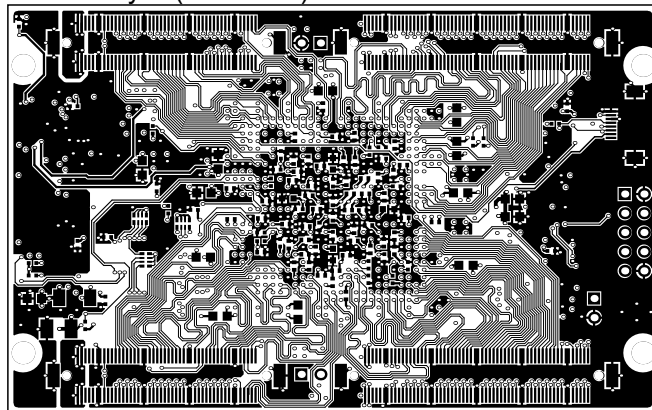

B

C

MidLayer1 (Scale 1:1)

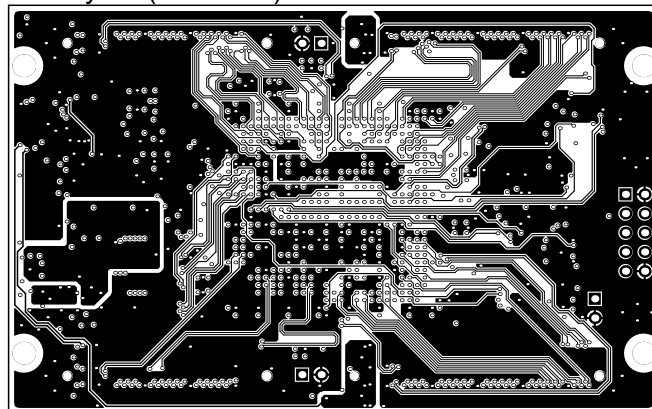

MidLayer2 (Scale 1:1)

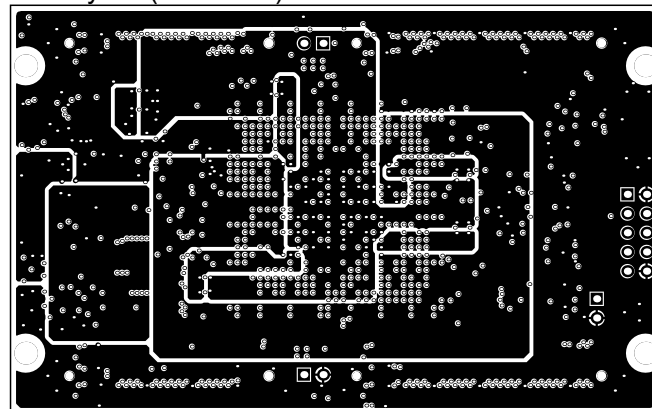

C

PCB Version : C

D



HuMANDATA LTD.
www.hdl.co.jp/ (Japan)
www2.hdl.co.jp/en/ (Global)

DSN

TITLE:

ACM-208 PCB Drawing

DOC.No:

PCB-ACM-208

REV

B

FILE:

DATE: 2023/08/10

Sheet

2 / 2

1 2 3 4 5 6 7 8

V3_20230404

D