

1 2 3 4 5 6 7 8

A

A

View from Top side (Scale 2:1)

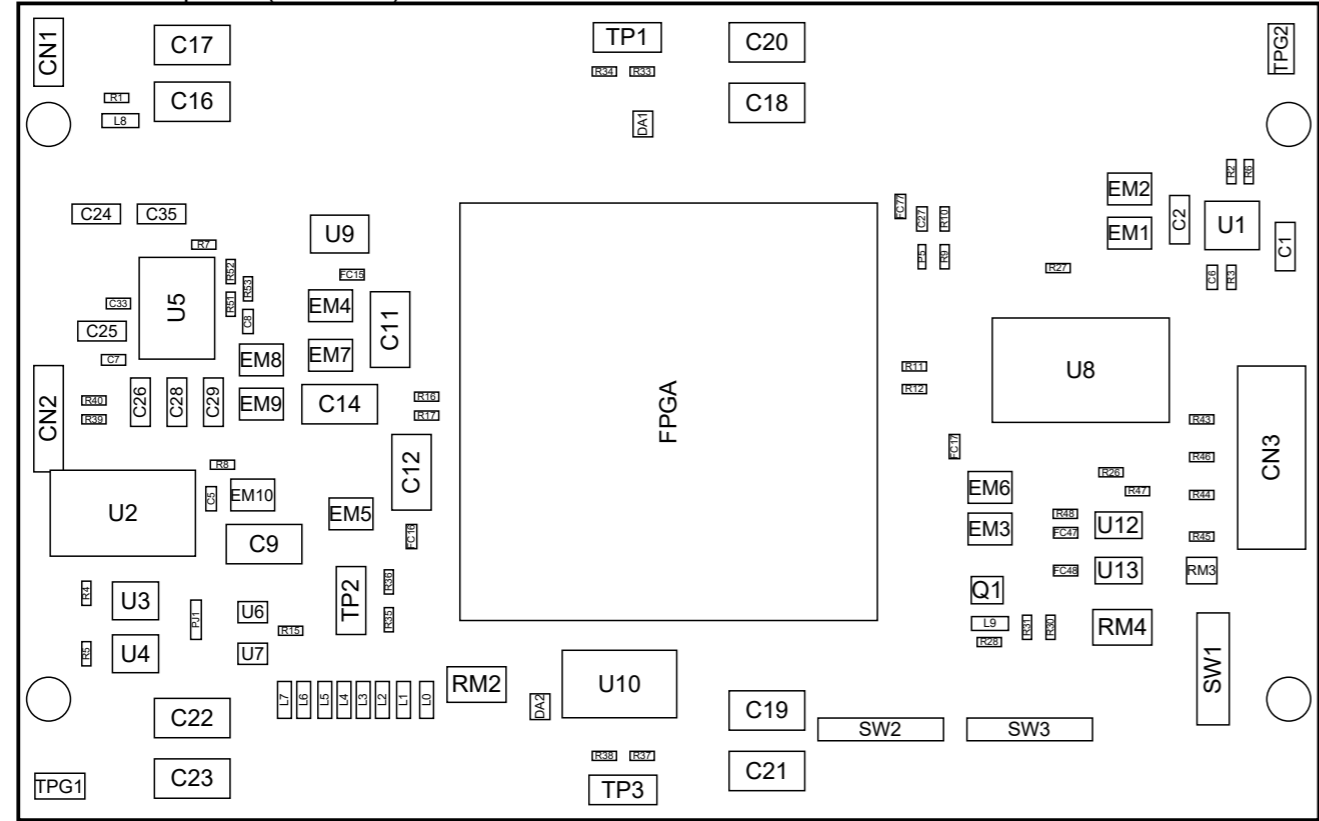

View from Bottom side (Scale 2:1)

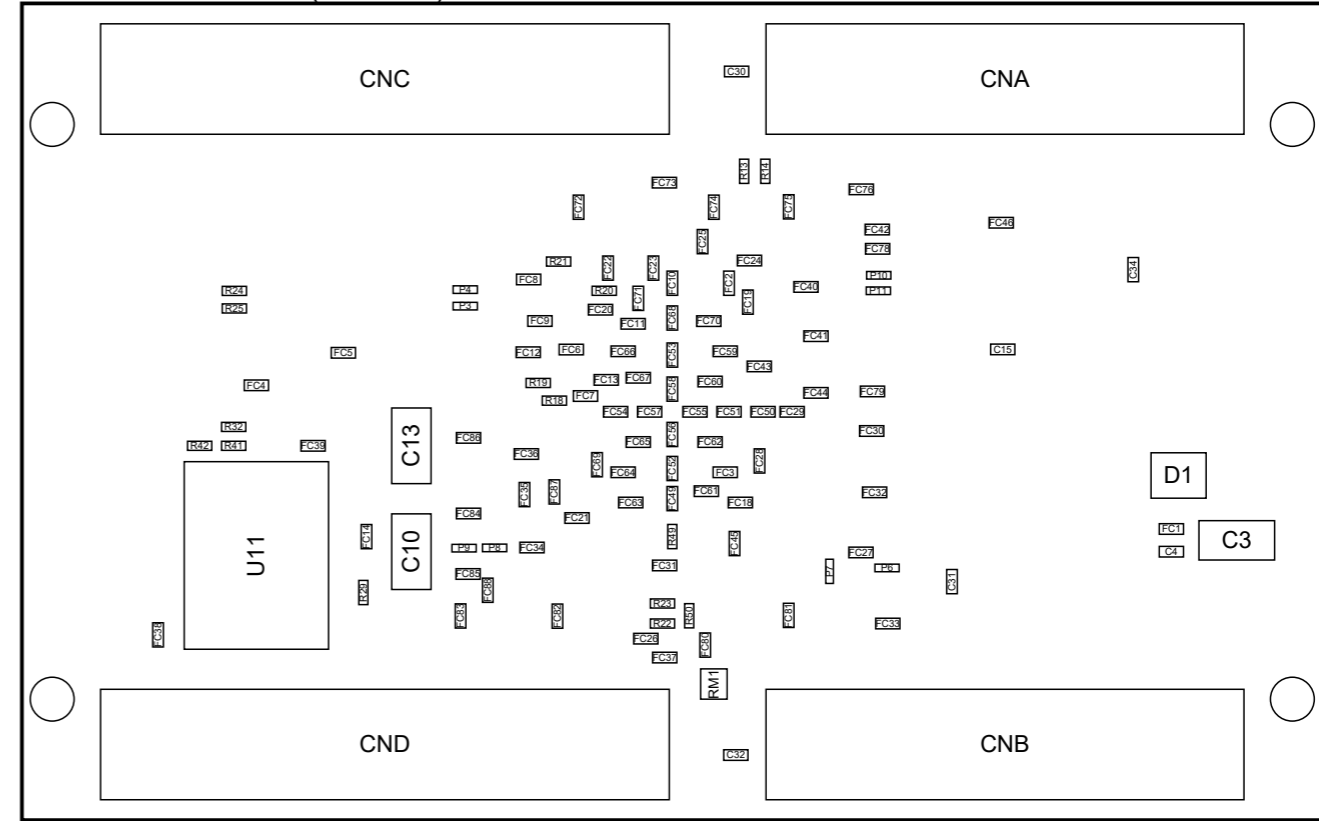

B

B

C

C

PCB Version : D



HuMANDATA LTD.  
www.hdl.co.jp/ (Japan)  
www2.hdl.co.jp/en/ (Global)

DSN	TITLE: ACM-205 PCB Drawing	
	DOC.No: PCB-ACM-205	REV B
	FILE:	DATE: 2022/12/16 Sheet: 1 / 2

D

D

1 2 3 4 5 6 7 8

1 2 3 4 5 6 7 8

A

TopLayer (Scale 1:1)

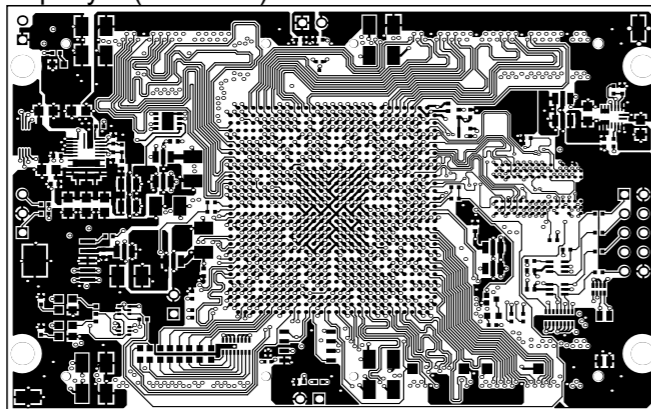

InternalPlane3 (Scale 1:1)



InternalPlane2 (Scale 1:1)

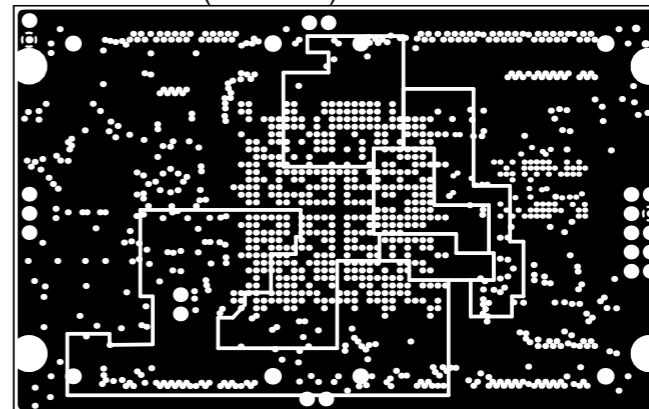

A

B

InternalPlane1 (Scale 1:1)

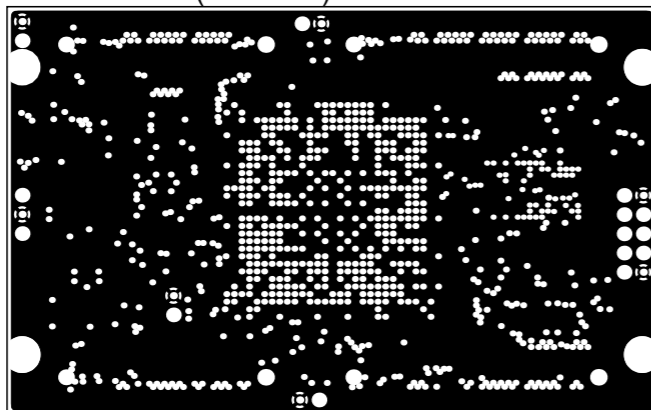

InternalPlane4 (Scale 1:1)

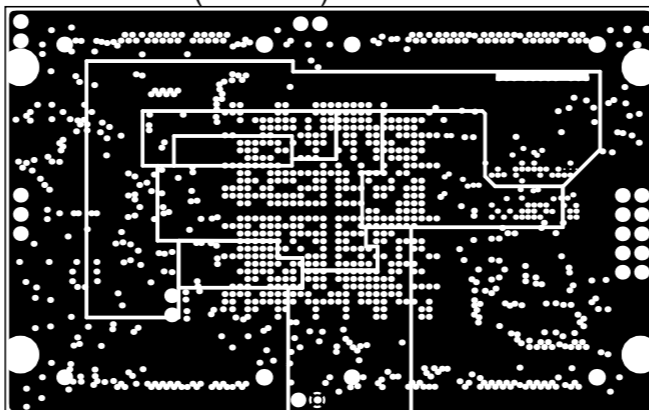

BottomLayer (Scale 1:1)

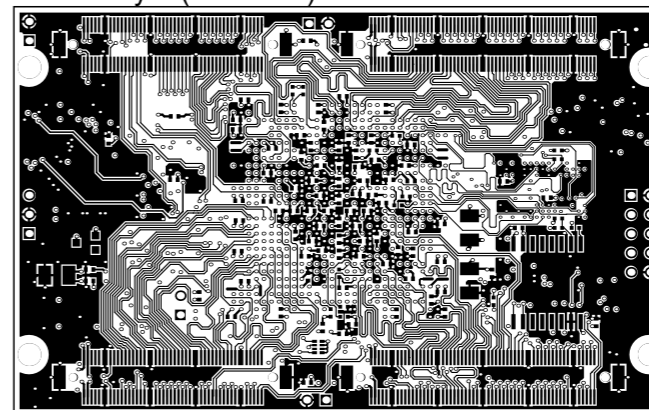

B

C

MidLayer1 (Scale 1:1)

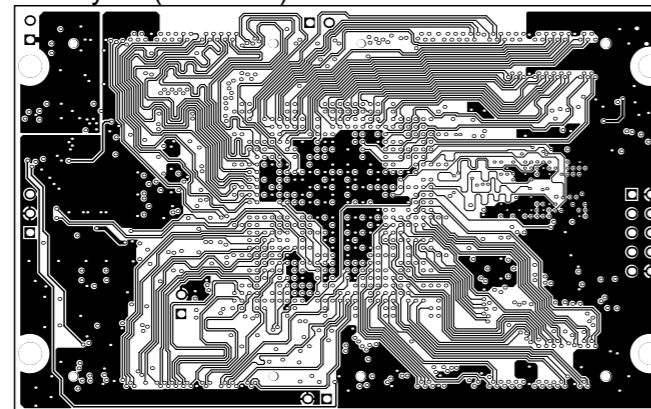

MidLayer2 (Scale 1:1)

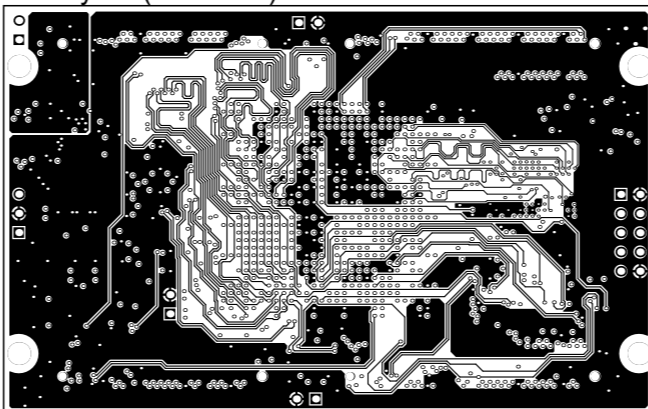

C

D

PCB Version : D



HuMANDATA LTD.  
www.hdl.co.jp/ (Japan)  
www2.hdl.co.jp/en/ (Global)

DSN

TITLE:

ACM-205 PCB Drawing

DOC.No:

PCB-ACM-205

REV

B

FILE:

DATE: 2022/12/16

Sheet

2 / 2

1 2 3 4 5 6 7 8

V2\_20210721

D