

View from Top side (Scale 2:1)

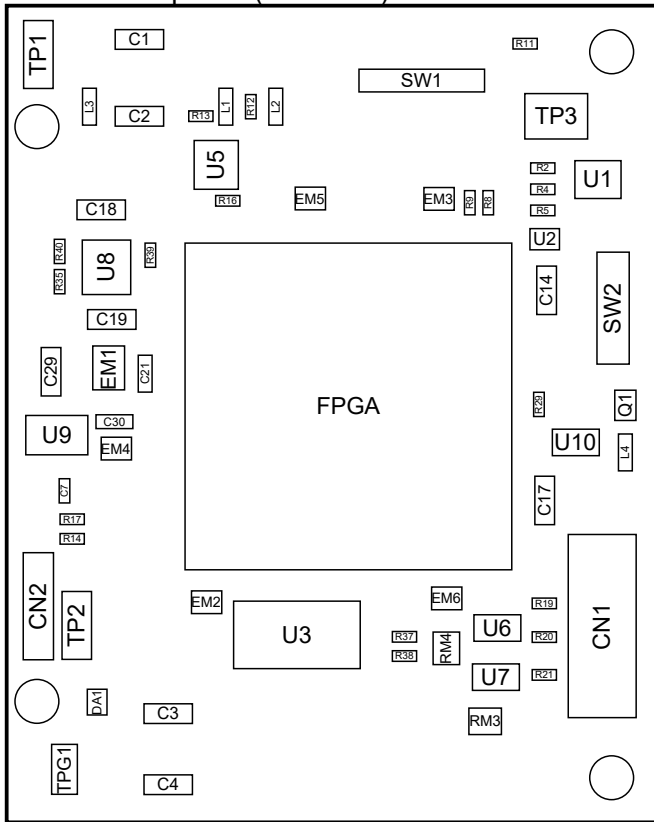

View from Bottom side (Scale 2:1)

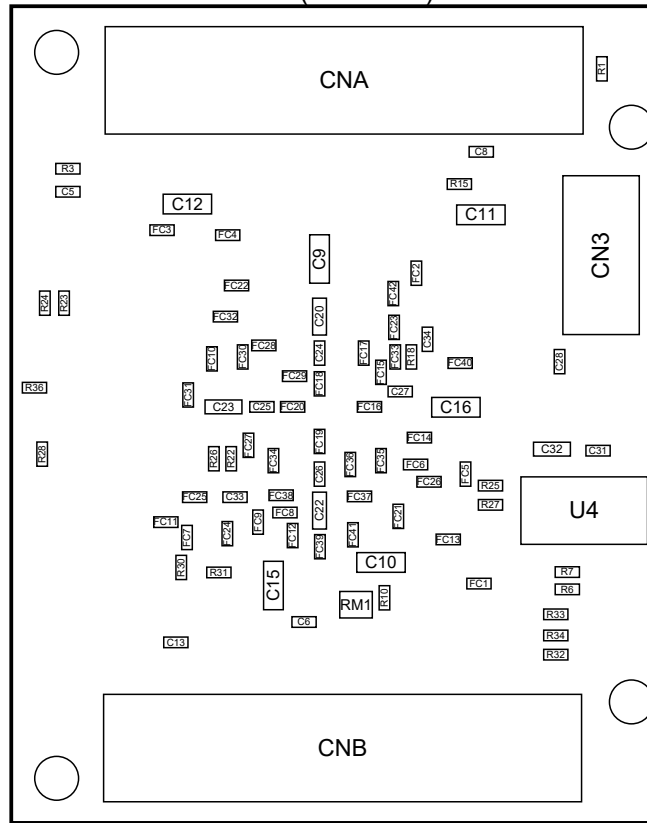

PCB Version : B



HuMANDATA LTD.
www.hdl.co.jp/ (Japan)
www2.hdl.co.jp/en/ (Global)

DSN

TITLE:

ACM-114 PCB Drawing

DOC.No:

PCB-ACM-114

REV

B

FILE:

DATE: 2023/09/28

Sheet:

1 / 2

V1_20191224

1

2

3

4

5

A

B

C

D

A

B

C

D

Top Layer (Scale 1:1)

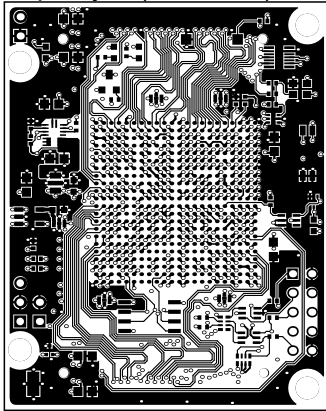

Signal Layer 1 (Scale 1:1)

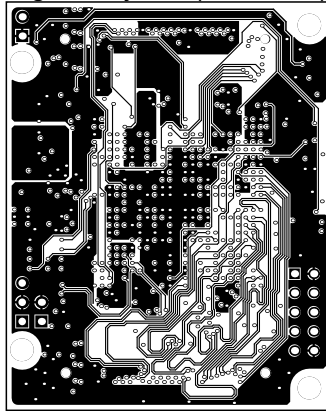

Internal Plane 3 (Scale 1:1)

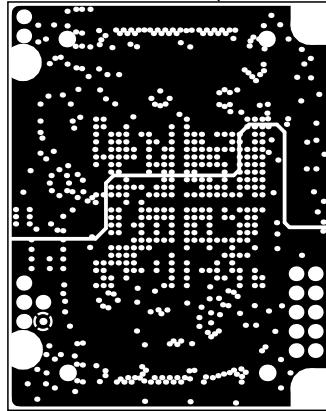

Signal Layer 2 (Scale 1:1)

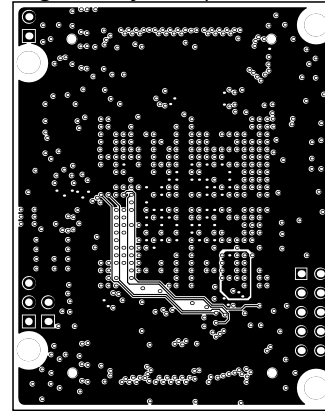

Internal Plane 1 (Scale 1:1)

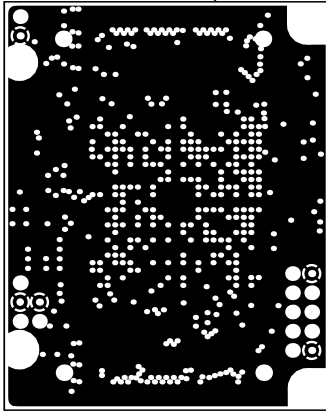

Internal Plane 2 (Scale 1:1)

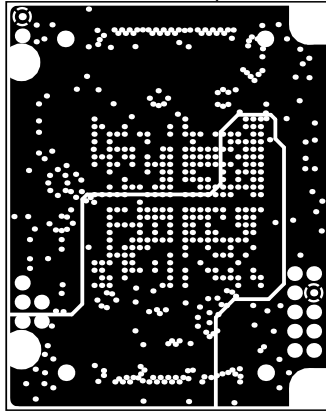

Internal Plane 4 (Scale 1:1)

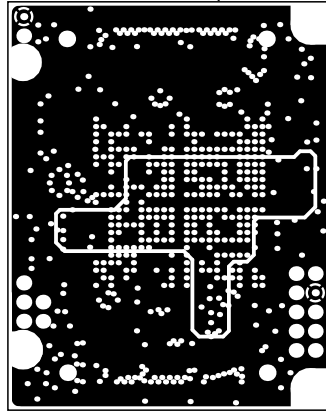

Bottom Layer (Scale 1:1)

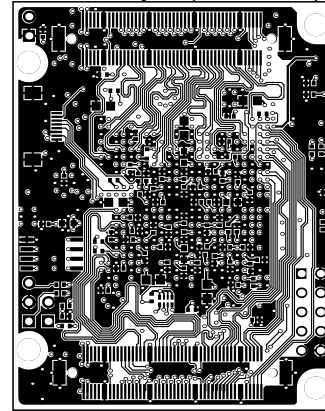

PCB Version : B



HuMANDATA LTD.
www.hdl.co.jp/ (Japan)
www2.hdl.co.jp/en/ (Global)

DSN

TITLE:

ACM-114 PCB Drawing

DOC.No:

PCB-ACM-114

REV

B

FILE:

DATE: 2023/09/28

Sheet: 2 / 2

1

2

3

4

5

V1_20191224