

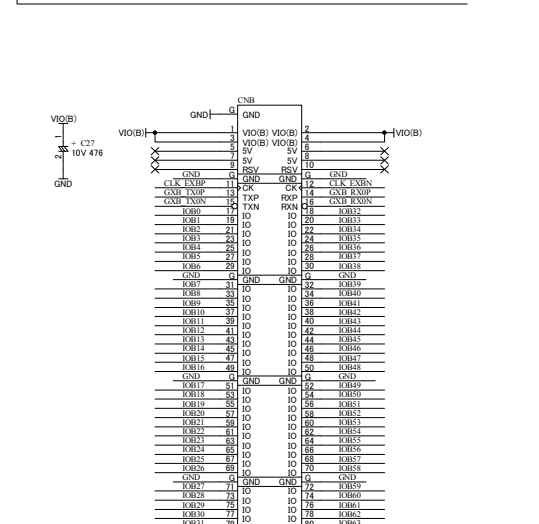

Bank Group A

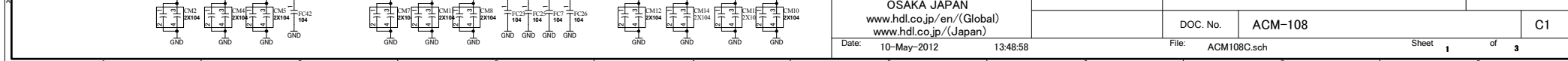

Bank Group B





HuMANDATA LTD.
OSAKA JAPAN
www.hdl.co.jp/en/(Global)
www.hdl.co.jp/(Japan)

ALTERA Cyclone IV GX F484 FPGA board

Doc. No. ACM-108

Date: 10-May-2012

Date:	10-May-2012	File:	ACM108C.sch	Sheet	1	of	3
-------	-------------	-------	-------------	-------	---	----	---

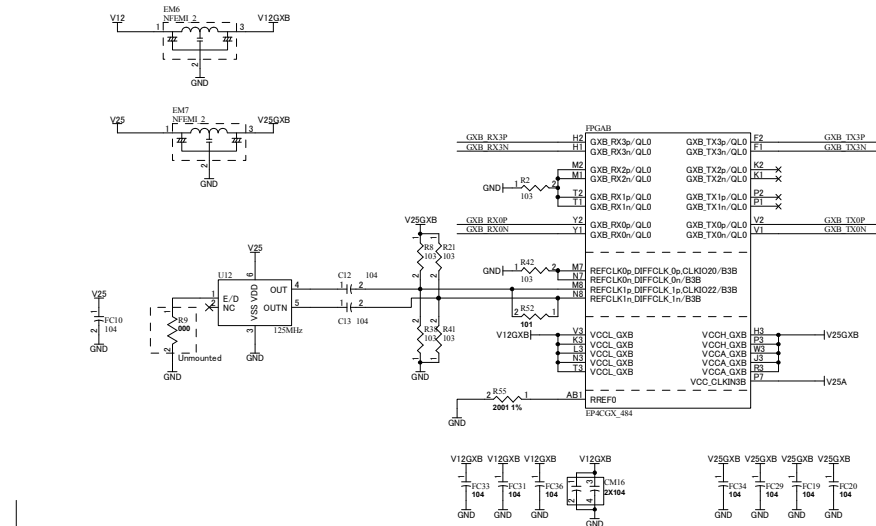
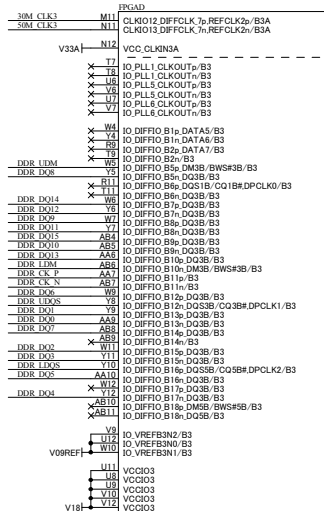
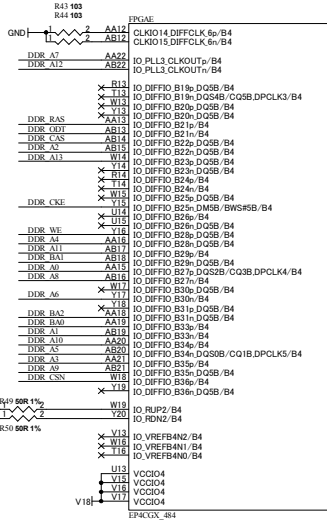
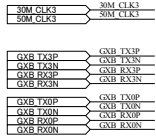
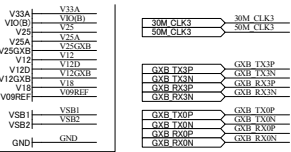

BOTTOM EDGE [BANK 3/4] for DDR2 SDRAM

LEFT EDGE for HI-SPEED TRASCEIVER

		ALTERA Cyclone IV GX F484 FPGA board	
HuMANDATA LTD. OSAKA JAPAN www.hdl.co.jp/en/(Global) www.hdl.co.jp/(Japan)		DOC. No.	ACM-108
Date:	10-May-2012	13:48:59	File: FPGA2.sch
		Sheet	3 of 3