

TOP LAYER

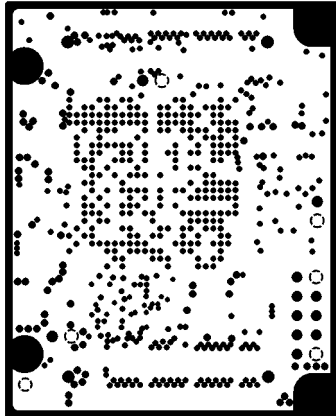

INTERNAL PLANE1

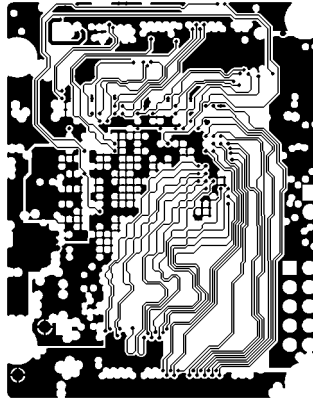

MID LAYER2

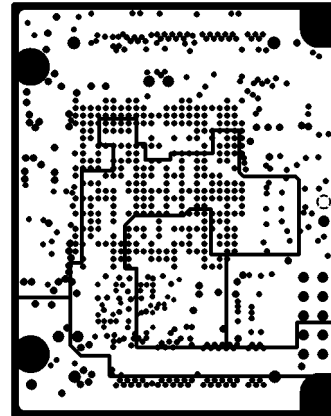

INTERNAL PLANE2

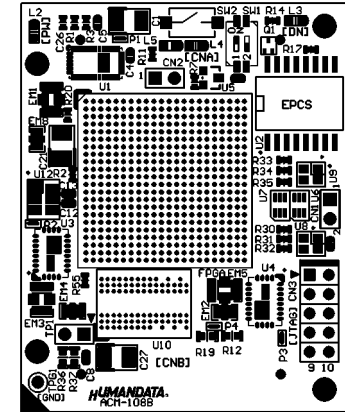

Component Side

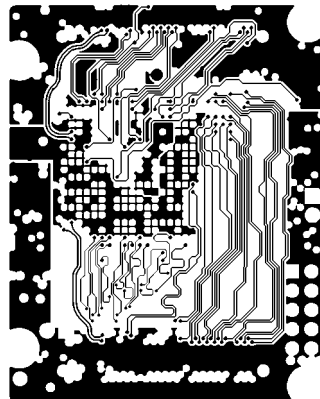

MID LAYER1

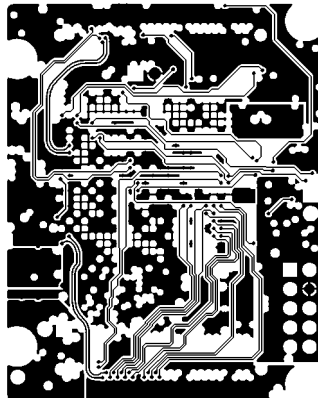

MID LAYER3

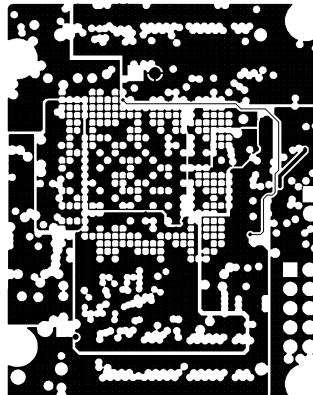

MID LAYER4

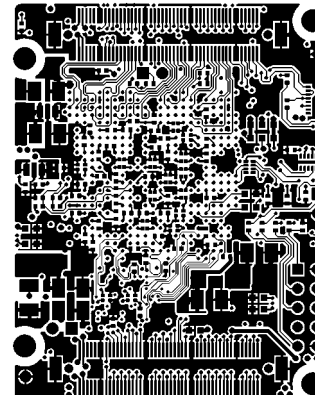

BOTTOM LAYER

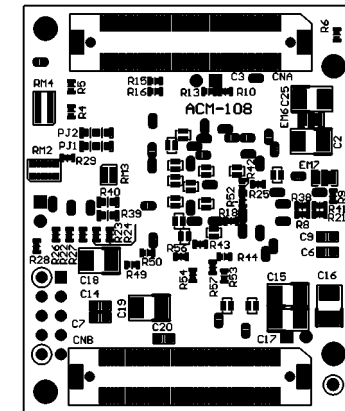

Solder Side

HUMANDATA		UNIT	TITLE	
		mm		
CHK	DWG	SIZE	DWG NO	REV
		1/1		

