

1 2 3 4 5 6 7 8

A

A

View from Top side (Scale 2:1)

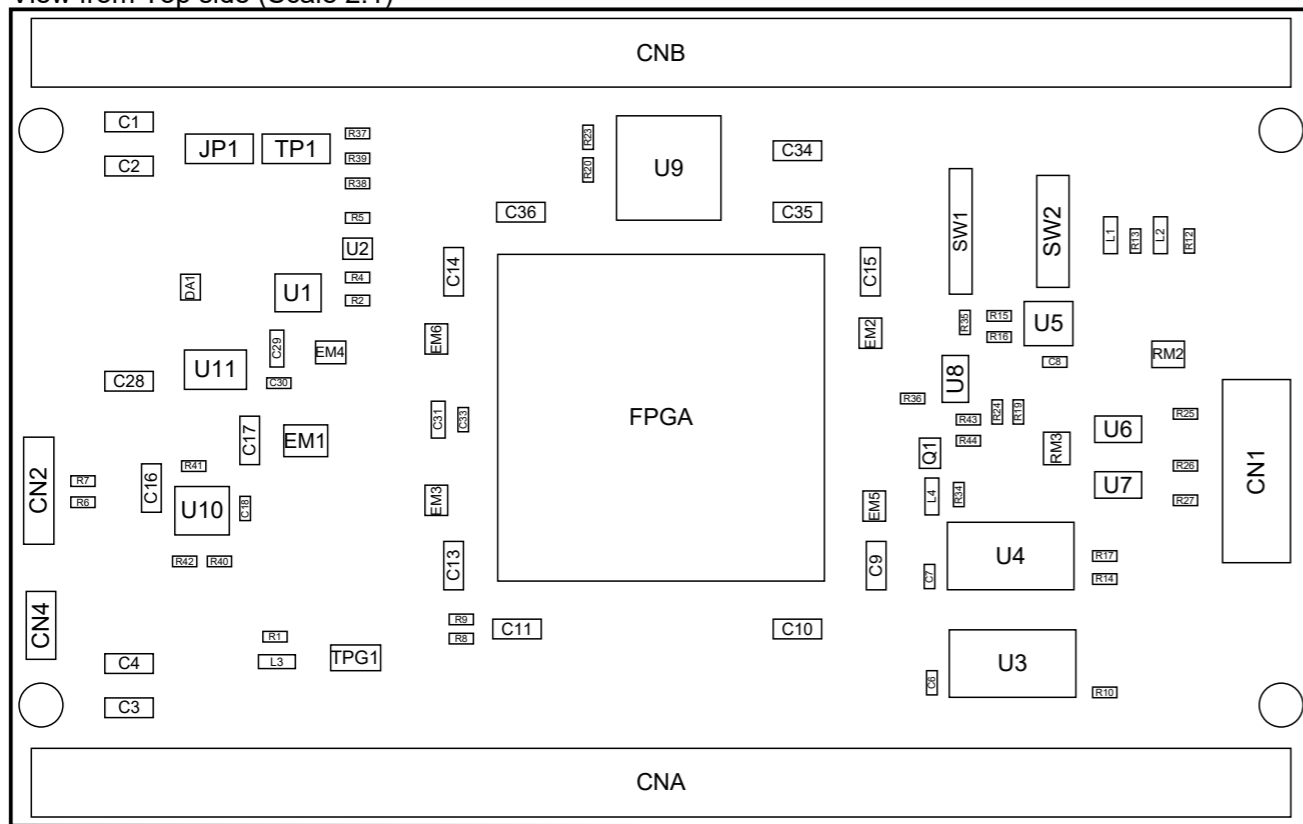

B

B

View from Bottom side (Scale 2:1)

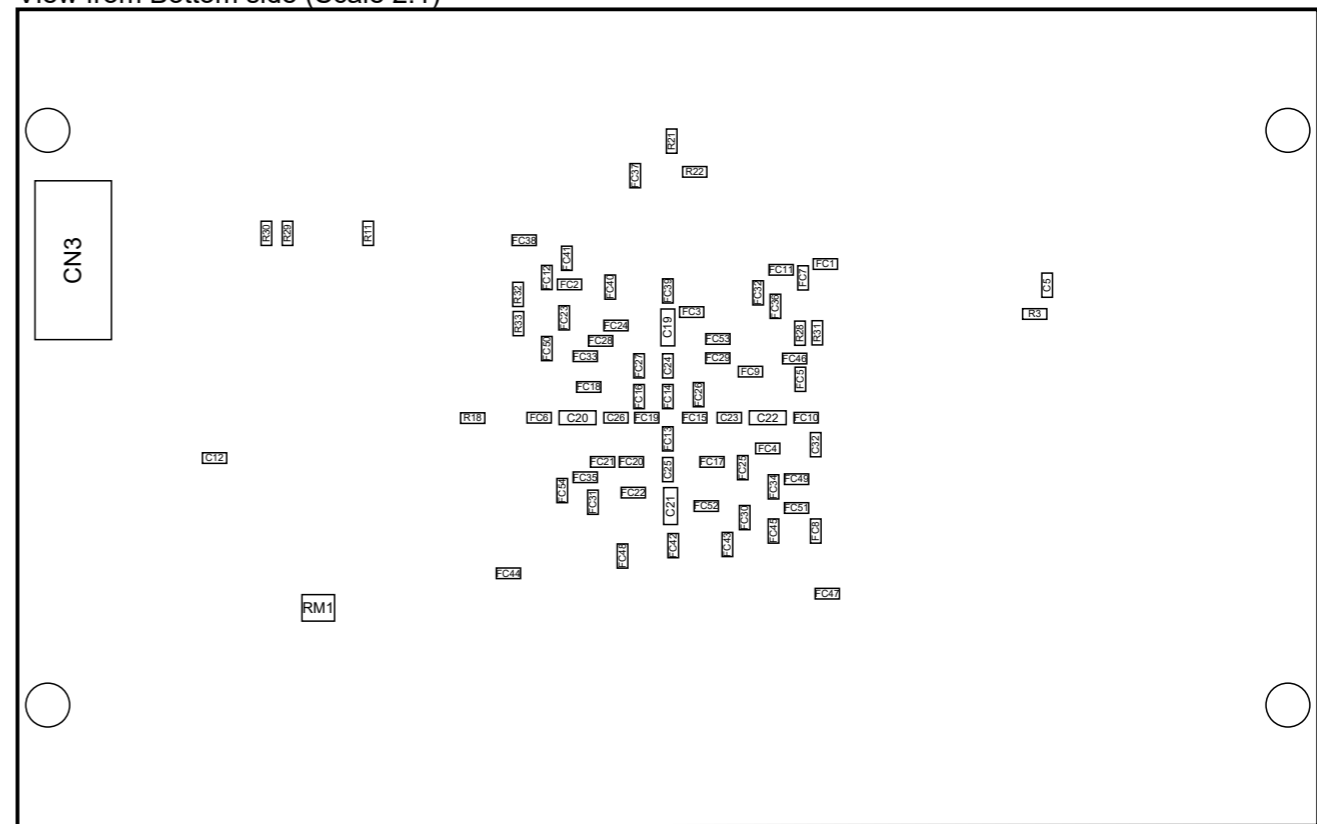

C

C

PCB Version : B

D

D



HuMANDATA LTD.  
www.hdl.co.jp/ (Japan)  
www2.hdl.co.jp/en/ (Global)

DSN	TITLE: ACM-033 PCB Drawing	
	DOC.No: PCB-ACM-033	REV B
	FILE:	DATE: 2023/08/23 Sheet: 1 / 2

1 2 3 4 5 6 7 8

1 2 3 4 5 6 7 8

A

A

Top Layer (Scale 1:1)

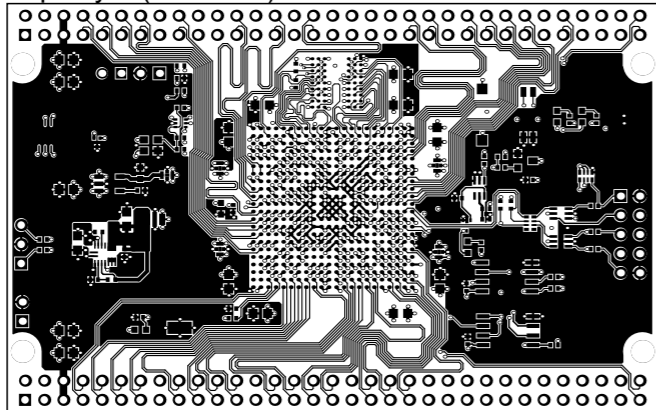

Signal Layer 1 (Scale 1:1)

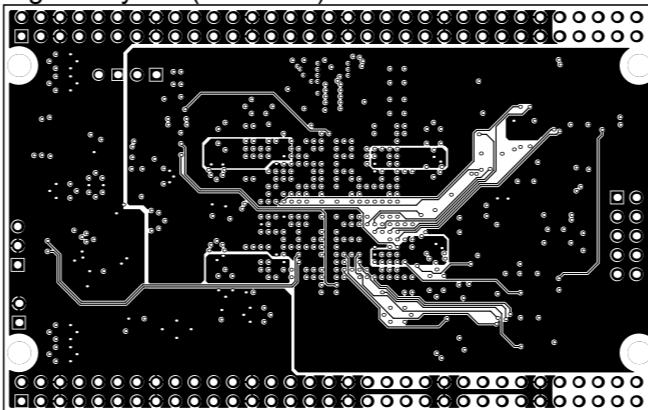

Internal Plane 2 (Scale 1:1)

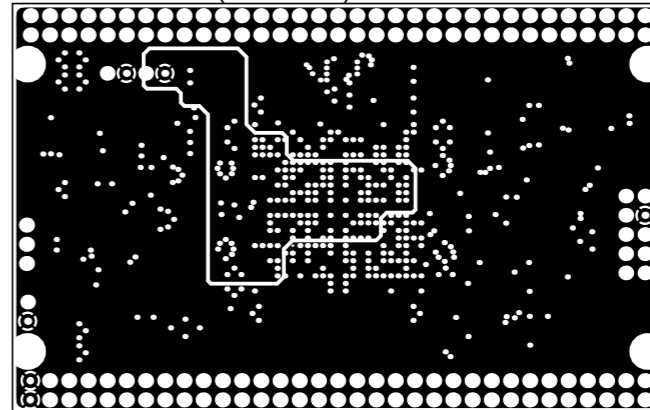

B

B

Internal Plane 1 (Scale 1:1)

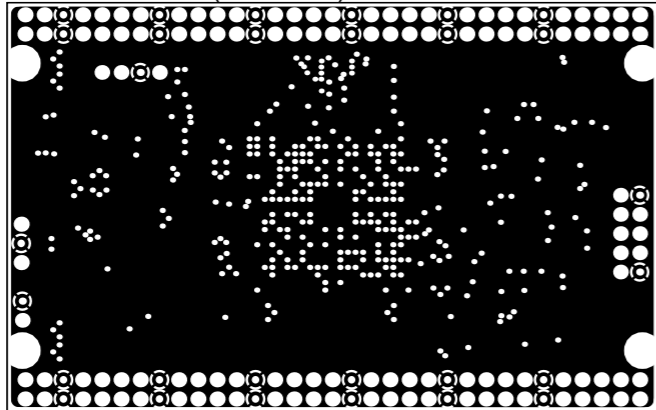

Signal Layer 2 (Scale 1:1)

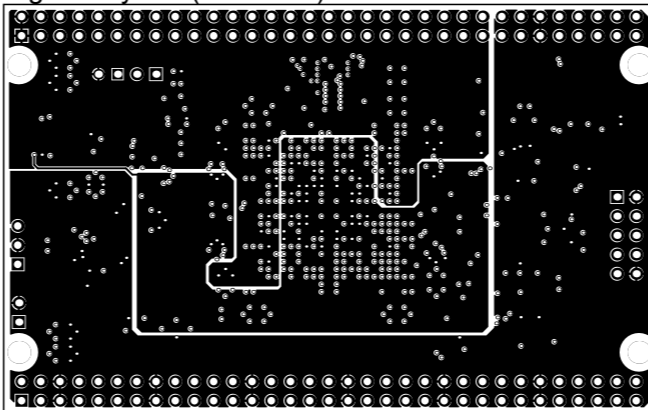

Bottom Layer (Scale 1:1)

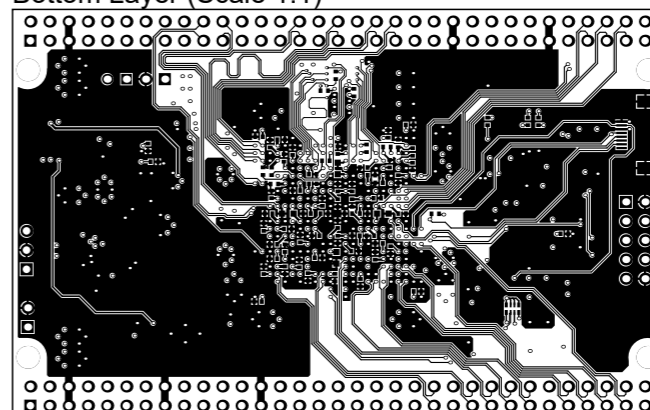

C

C

PCB Version : B

D

D



HuMANDATA LTD.  
www.hdl.co.jp/ (Japan)  
www2.hdl.co.jp/en/ (Global)

DSN

TITLE:

ACM-033 PCB Drawing

DOC.No:

PCB-ACM-033

REV

B

FILE:

DATE: 2023/08/23

Sheet

2 / 2

1 2 3 4 5 6 7 8

V3\_20230404