

1 2 3 4 5 6 7 8

A

A

View from Top side (Scale 2:1)

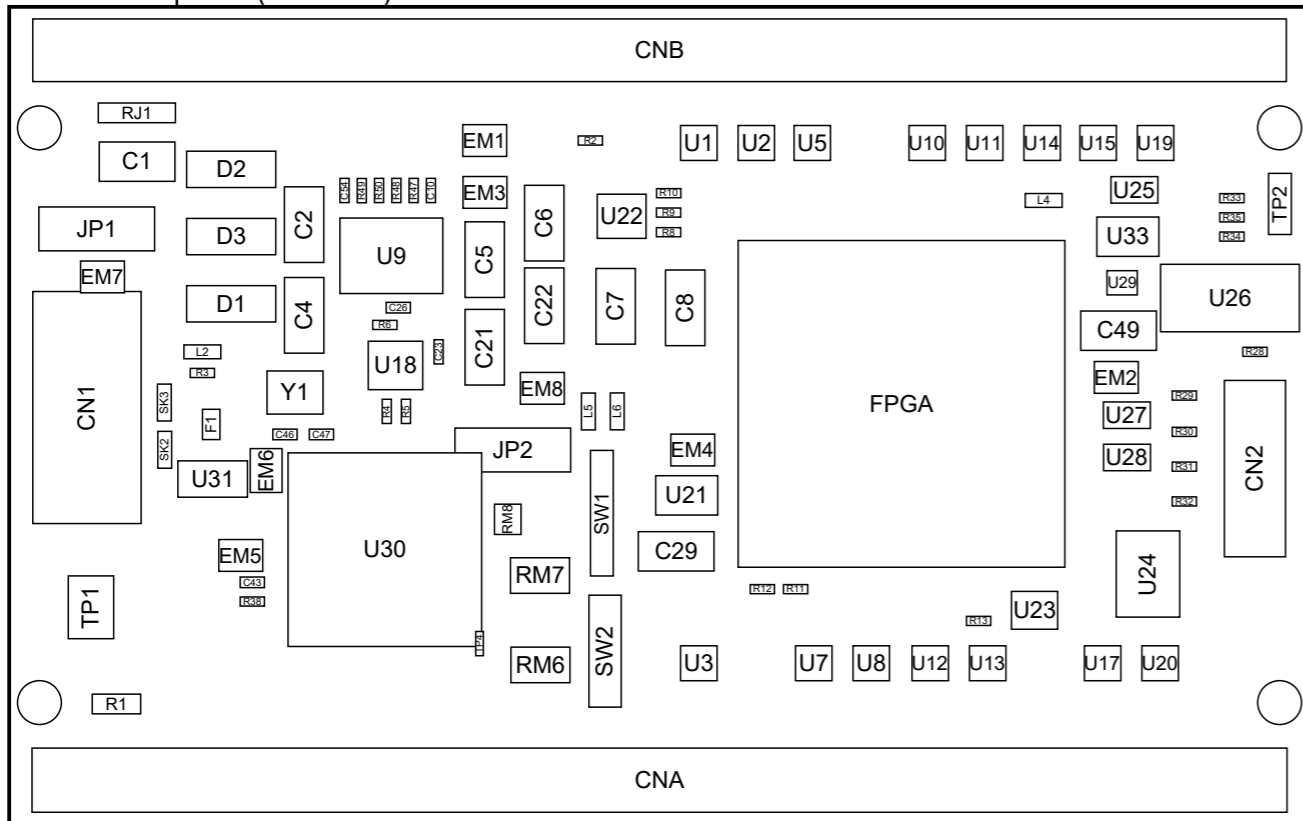

View from Bottom side (Scale 2:1)

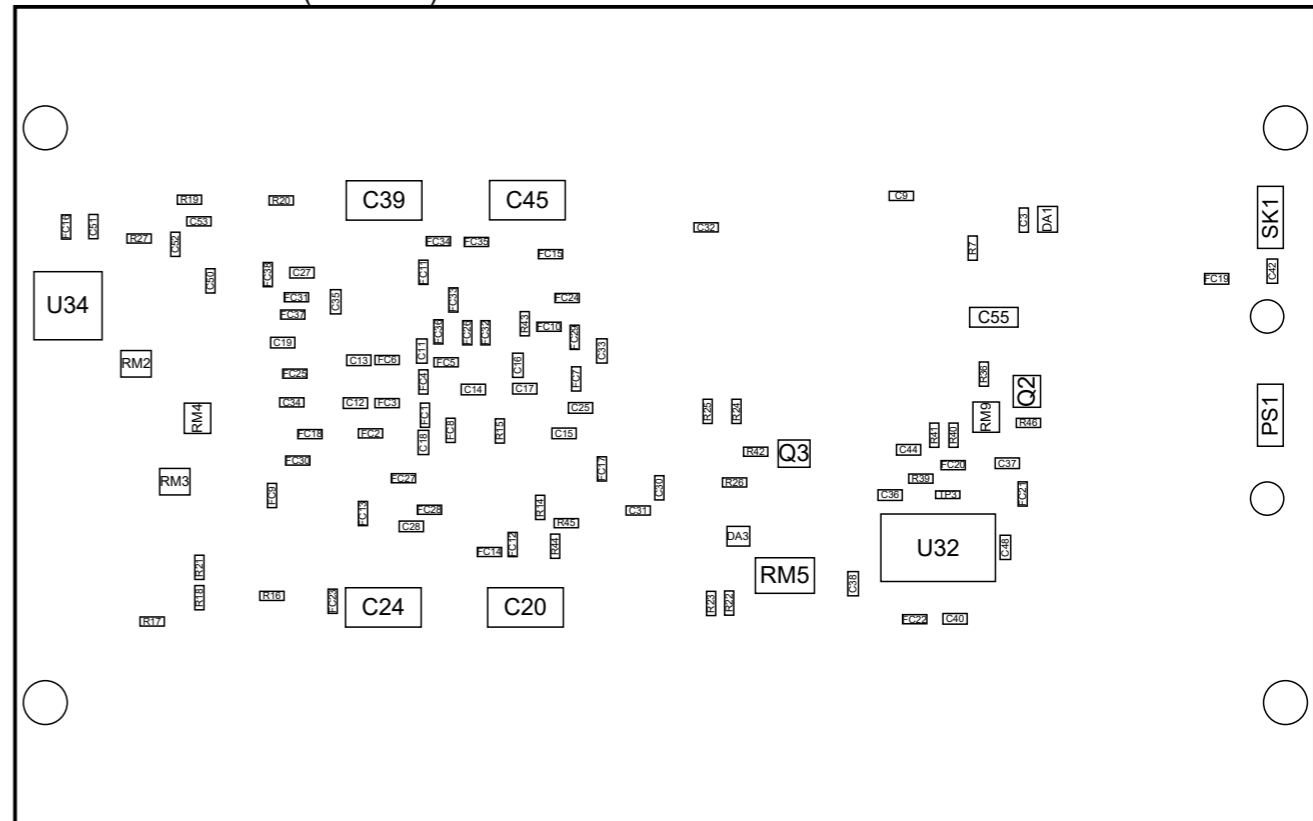

B

B

C

C

PCB Version : C



HuMANDATA LTD.  
www.hdl.co.jp/ (Japan)  
www2.hdl.co.jp/en/ (Global)

DSN	TITLE: EDA-008 PCB Drawing	
	DOC.No: EDA008-PCB-C	REV C
	FILE:	DATE: 2022/10/06 Sheet: 1 / 2

D

D

1 2 3 4 5 6 7 8

1 2 3 4 5 6 7 8

A

TopLayer (Scale 1:1)

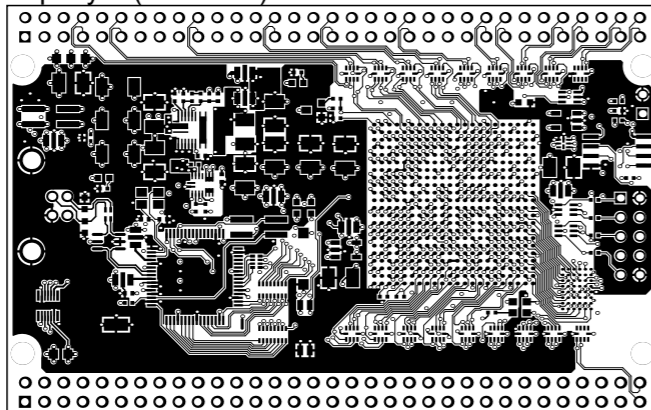

InternalPlane3 (Scale 1:1)

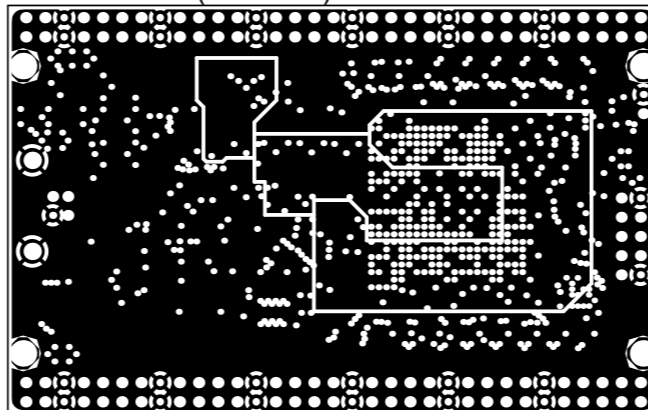

InternalPlane2 (Scale 1:1)

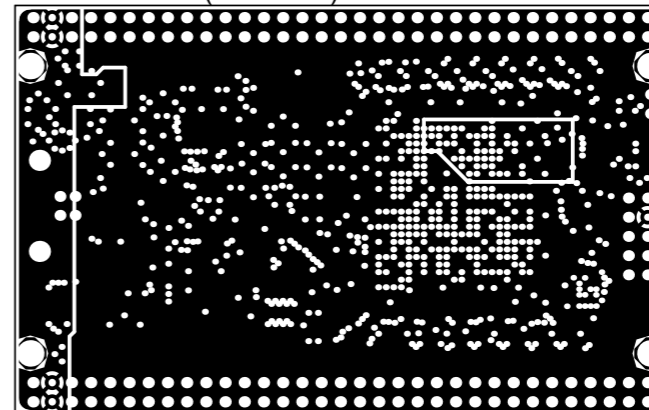

A

B

InternalPlane1 (Scale 1:1)

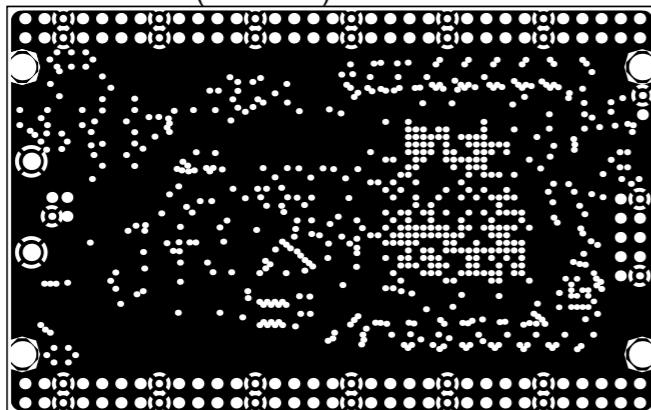

InternalPlane4 (Scale 1:1)

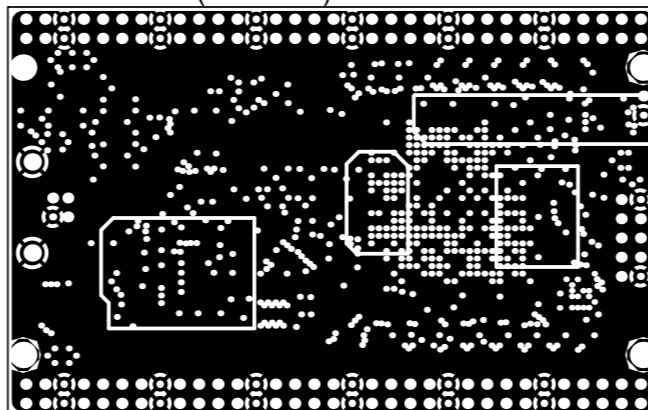

BottomLayer (Scale 1:1)

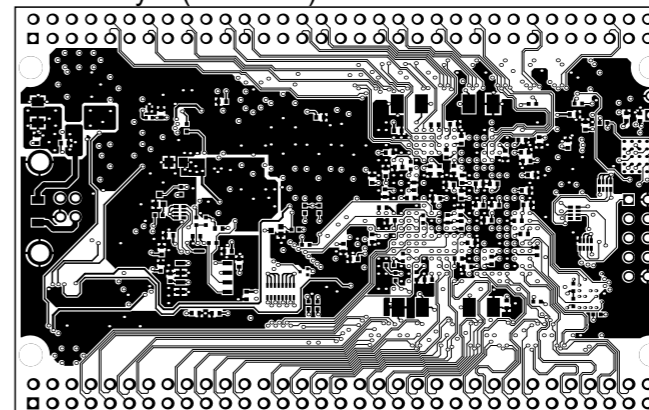

B

C

MidLayer1 (Scale 1:1)

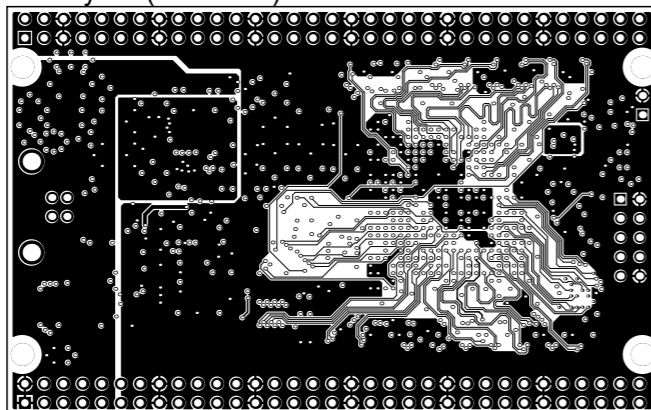

MidLayer2 (Scale 1:1)

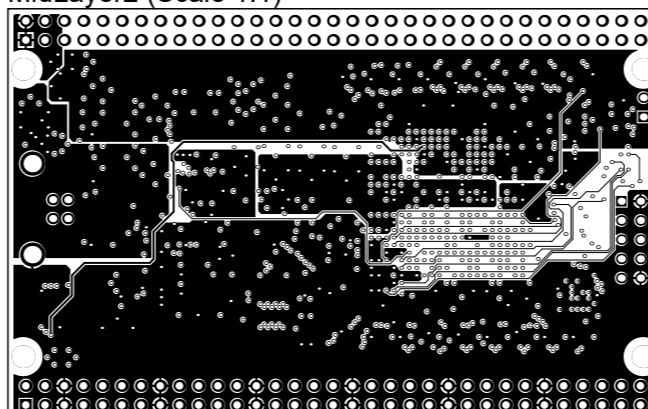

C

PCB Version : C

D



HuMANDATA LTD.  
www.hdl.co.jp/ (Japan)  
www2.hdl.co.jp/en/ (Global)

DSN	TITLE: EDA-008 PCB Drawing	
	DOC.No: EDA008-PCB-C	REV C
	FILE:	DATE: 2022/10/06 Sheet: 2 / 2

D

1 2 3 4 5 6 7 8