

View from Top side (Scale 2:1)

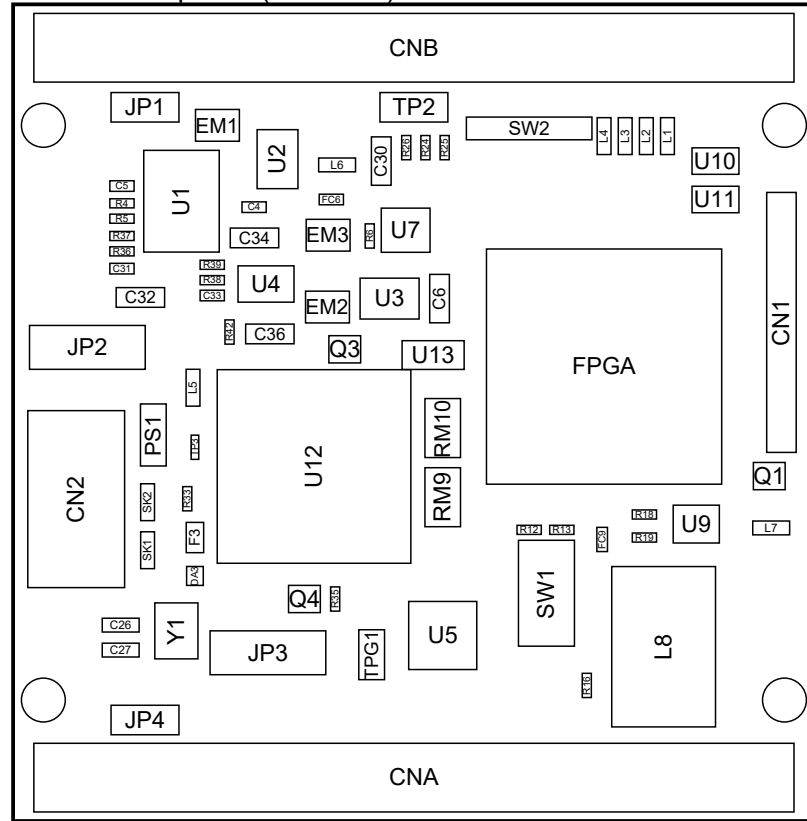

View from Bottom side (Scale 2:1)

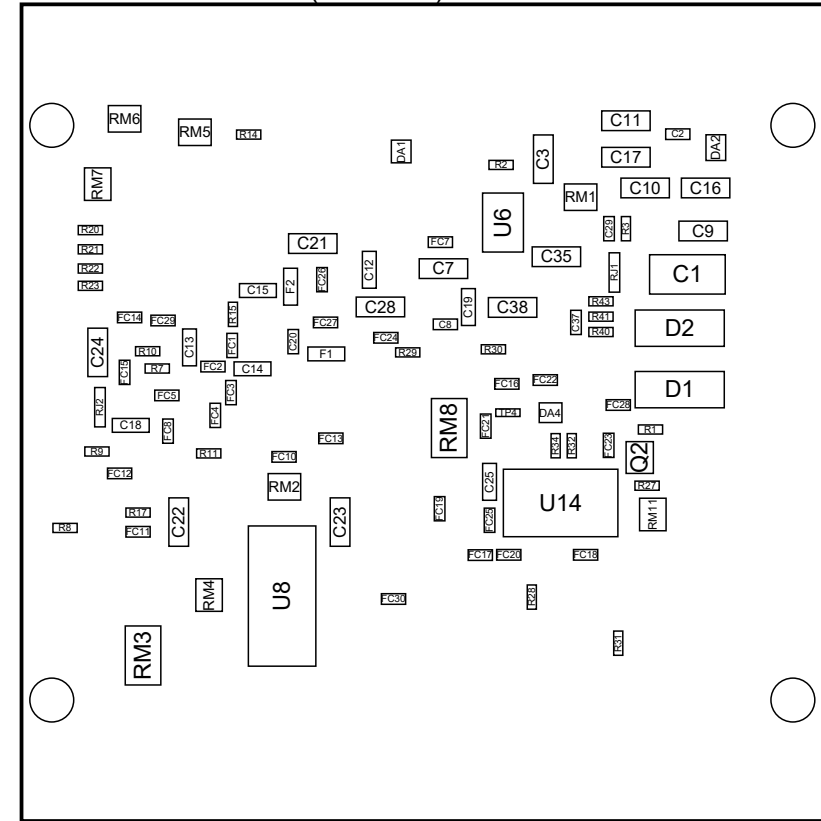

PCB Version : E



HuMANDATA LTD.
www.hdl.co.jp/ (Japan)
www2.hdl.co.jp/en/ (Global)

DSN	TITLE: EDX-302 PCB Drawing		REV B
	DOC.No: PCB-EDX-302		
	FILE:	DATE: 2022/10/27	Sheet: 1 / 2

TopLayer (Scale 1:1)

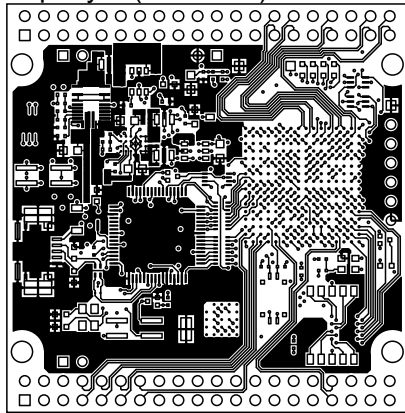

Signal Layer 1 (Scale 1:1)

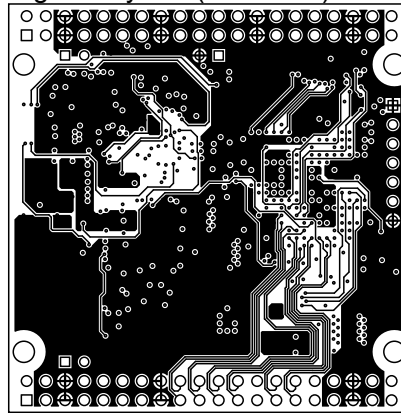

Internal Plane2 (Scale 1:1)

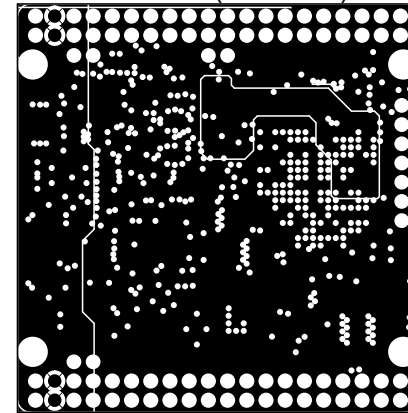

InternalPlane1 (Scale 1:1)

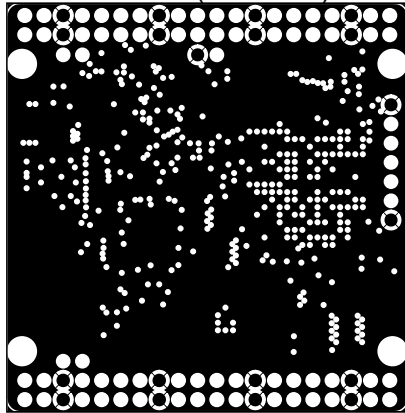

Signal Layer 2 (Scale 1:1)

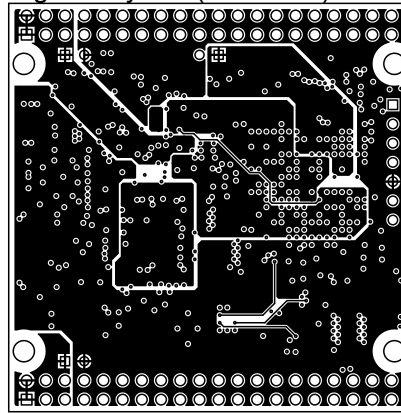

BottomLayer (Scale 1:1)

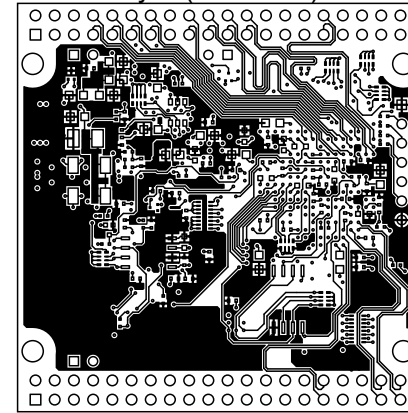

PCB Version : E



HuMANDATA LTD.
www.hdl.co.jp/ (Japan)
www2.hdl.co.jp/en/ (Global)

DSN

TITLE:

EDX-302 PCB Drawing

DOC.No:

PCB-EDX-302

REV

B

FILE:

DATE: 2022/10/27

Sheet: 2 / 2

V1_20191224