

View from Top side (Scale 2:1)

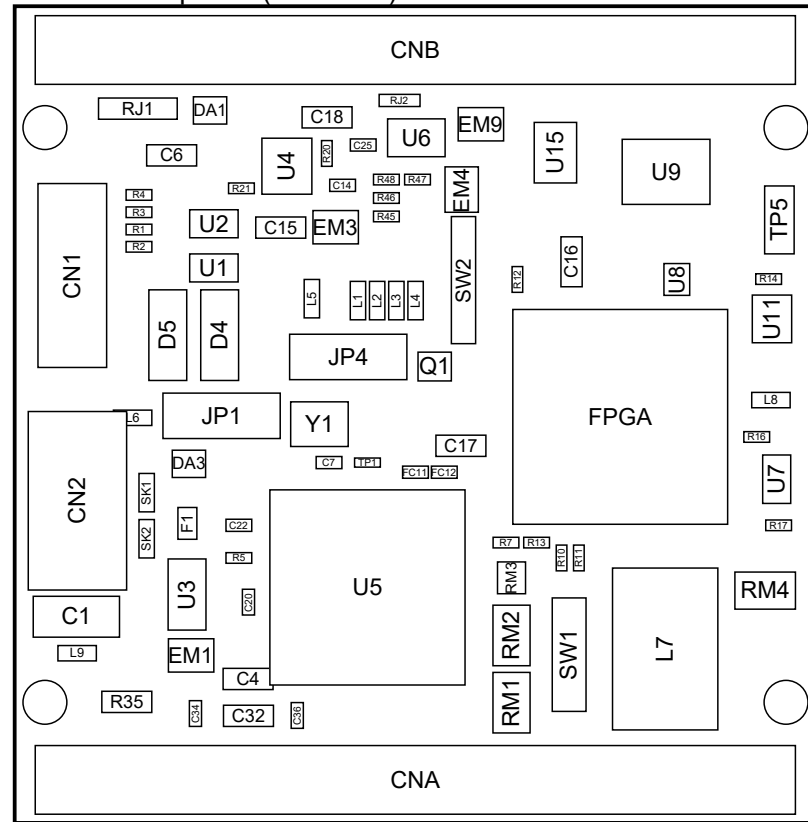

View from Bottom side (Scale 2:1)

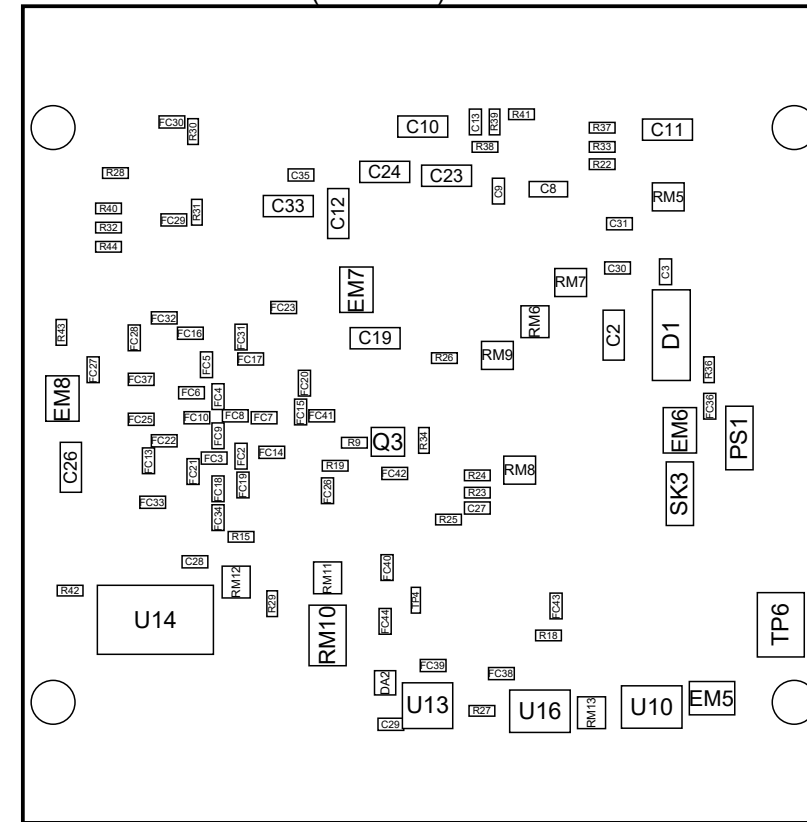

PCB Version : D



HuMANDATA LTD.
www.hdl.co.jp/ (Japan)
www2.hdl.co.jp/en/ (Global)

DSN	TITLE: EDA-302 PCB Drawing	
	DOC.No: PCB-EDA-302	REV C
FILE:	DATE: 2023/10/25	Sheet: 1 / 2

TopLayer (Scale 1:1)

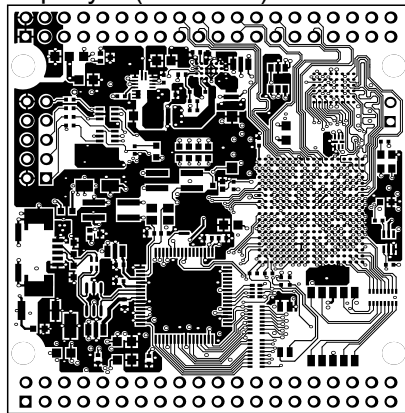

MidLayer1 (Scale 1:1)

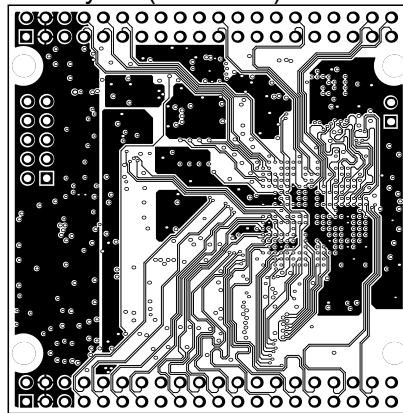

InternalPlane4 (Scale 1:1)

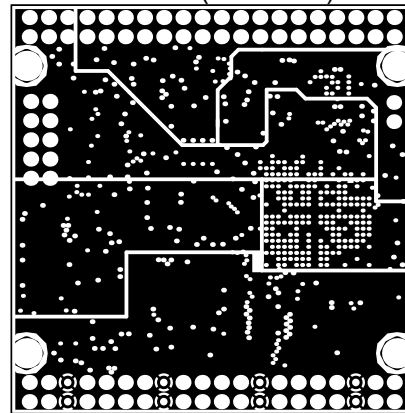

InternalPlane2 (Scale 1:1)

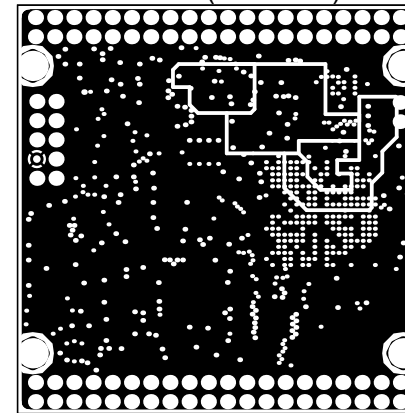

InternalPlane1 (Scale 1:1)

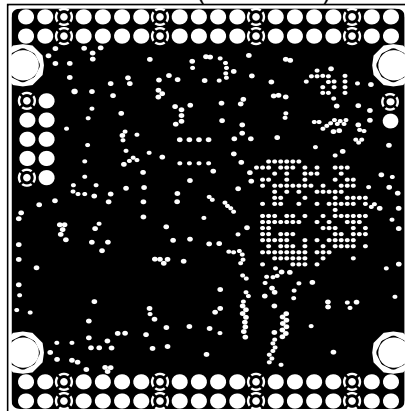

InternalPlane3 (Scale 1:1)

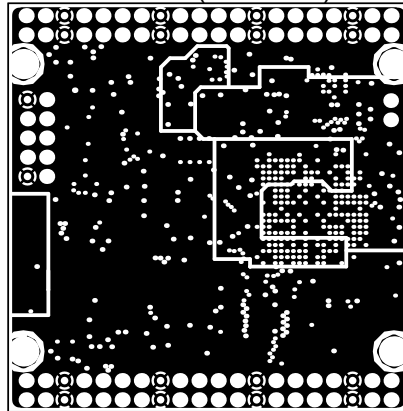

MidLayer2 (Scale 1:1)

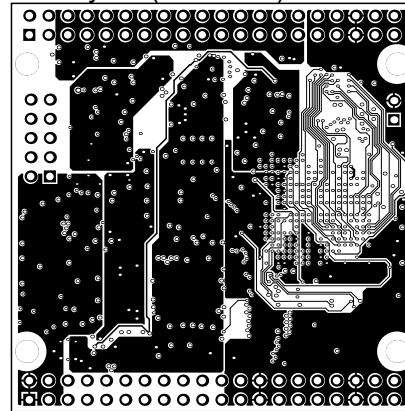

BottomLayer (Scale 1:1)

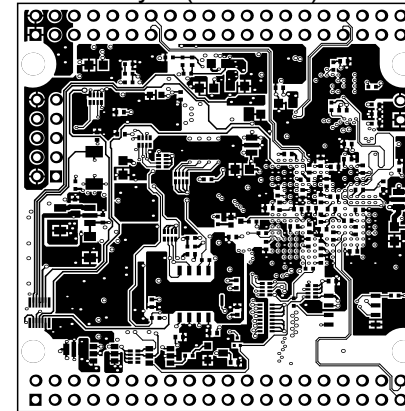

PCB Version : D

HUMANDATA

HuMANDATA LTD.
www.hdl.co.jp/ (Japan)
www2.hdl.co.jp/en/ (Global)

DSN

TITLE:

EDA-302 PCB Drawing

DOC.No:

PCB-EDA-302

REV

C

FILE:

DATE: 2023/10/25

Sheet: 2 / 2

V1_20191224