

LPT-CAPTURE-LAN



Parallel/LAN Converter

LNX-201

User's Manual

Ver. 1.2

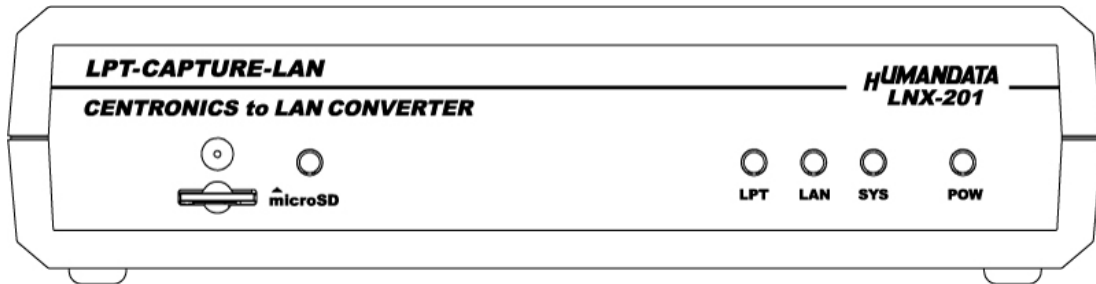



Table of Contents

● Precautions.....	2
● Revision History	1
● Introduction.....	1
1. Product Configuration.....	1
2. Product Summary	1
3. Overview	2
3.1. Front Side	2
3.2. Rear Side.....	3
4. Specifications	4
4.1. AC adapter (Japan's specifications).....	5
4.2. Optional Accessories	5
4.3. Power Supply.....	5
5. Connection examples.....	6
6. Setting Tool	7
6.1. Access Flow of microSD card.....	8
6.2. Write Setting Data	9
6.3. Read Setting Data.....	11
6.4. Write or Read setting data over the network.....	13
6.5. Setting Example.....	14
7. Virtual COM Port.....	16
8. Additional Documentation and User Support.....	17
9. Warranty and Compensation.....	17

● **Precautions**

 <p>Do Not</p>	1	This product uses ordinary off-the-shelf electronic components, and is therefore inappropriate for use in applications that require special quality or reliability and are expected to protect human lives or prevent accidents, such as safety mechanisms in fields including space, aeronautics, medicine, and nuclear power.
	2	Do not be used underwater or in high-humidity environments.
	3	Do not be used in the presence of corrosive gases, combustible gases, or other flammable gases.
	4	Do not turn on power when circuit board surface is in contact with other metal.
	5	Do not apply voltage higher than rated voltage.

 <p>Attention</p>	6	This manual may be revised in the future without notice owing to improvements.
	7	All efforts have been made to produce the best manual possible, but if users notice an error or other problem, we ask that they notify us.
	8	Item 7 notwithstanding, HuMANDATA cannot be held liable for the consequences arising from use of this product.
	9	HuMANDATA cannot be held liable for consequences arising from using this product in a way different from the uses described herein, or from uses not shown herein.
	10	This manual, circuit diagrams, sample circuits, and other content may not be copied, reproduced, or distributed without permission.
	11	If the product emits smoke, catches fire, or becomes unusually hot, cut the power immediately.
	12	Do not install the control cables or communication cables together with the main circuit lines or power cables. In such an environment, it may result in malfunction due to noise.
	13	Be careful of static electricity.

● Revision History

Date	Revision	Description
Jan. 23, 2019	v1.0	Initial release
Feb. 20, 2025	v1.1	Update: 4.2. Optional Accessories
Mar. 11, 2026	v1.2	Change: Specifications of AC adaptor Update: 4.2. Optional Accessories

● Introduction

Thank you very much for purchasing our product LPT-CAPTURE-LAN, LNX-201. LNX-201 is a parallel signal converter which make it possible to capture parallel signal from a general printer interface via LAN.

1. Product Configuration

The following lists the product configuration of the LNX-201.

LPT-CAPTURE-LAN (LNX-201)	1
microSD card with USB adapter	1
AC adapter (DC5V)	1
Driver & Application CD	1

2. Product Summary

LNX-201 can capture print data to your computer from a distant device which has printer interface. For example, LNX-201 can convert HPGL output from an oscilloscope or a measuring instrument to the image file, such as a JPEG format. Please note that LNX-201 does not support parallel output. It is only support parallel input. Any application for capture is not bundled.

LNX-201 supports PoE. That makes it possible to be powered via a LAN cable (PoE compatible HUB or other is required). It can also be powered by the AC adapter. Network setting can be saved to and restored from a microSD card. Restoring the setting information from a microSD card is very convenient when replacing LNX-201.

3. Overview

3.1. Front Side

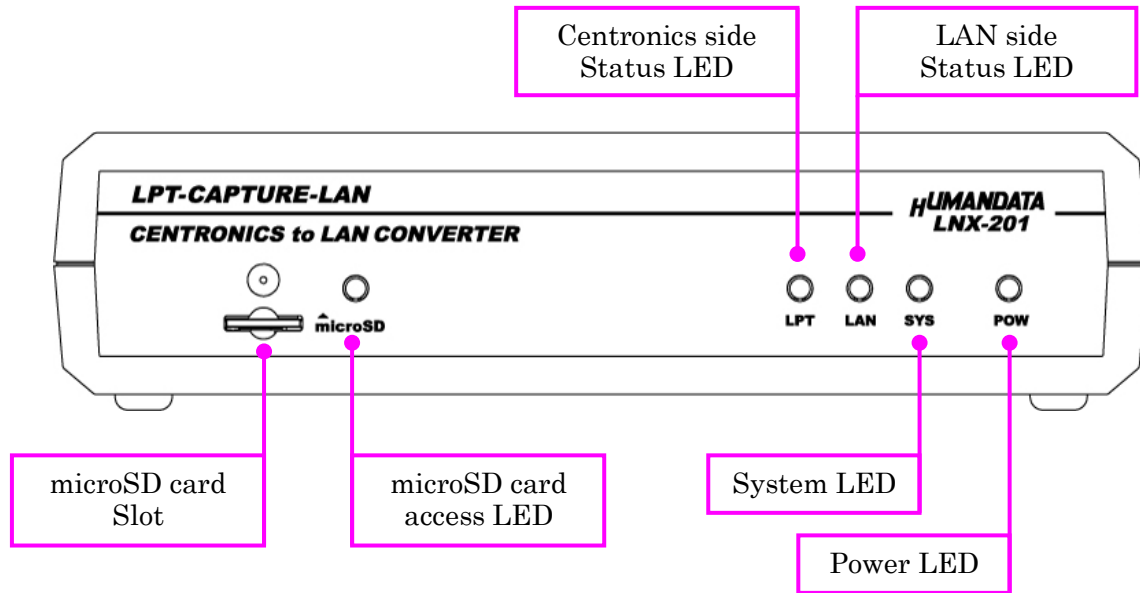

LEDs

	Name (color)	Function
POW	Power LED (red)	Turn on during the power is supplied.
SYS	System LED (red)	Blink few seconds during reading process. Turn on when system is ready.
LAN	LAN side Status LED (red)	Turn on when there is output data to LAN side.
LPT	Centronics side Status LED (red)	Turn on when there is input data from Centronics side
microSD	microSD card access LED (red)	Turn on during accessing microSD card. When it turned off, you can extract the card.

3.2. Rear Side

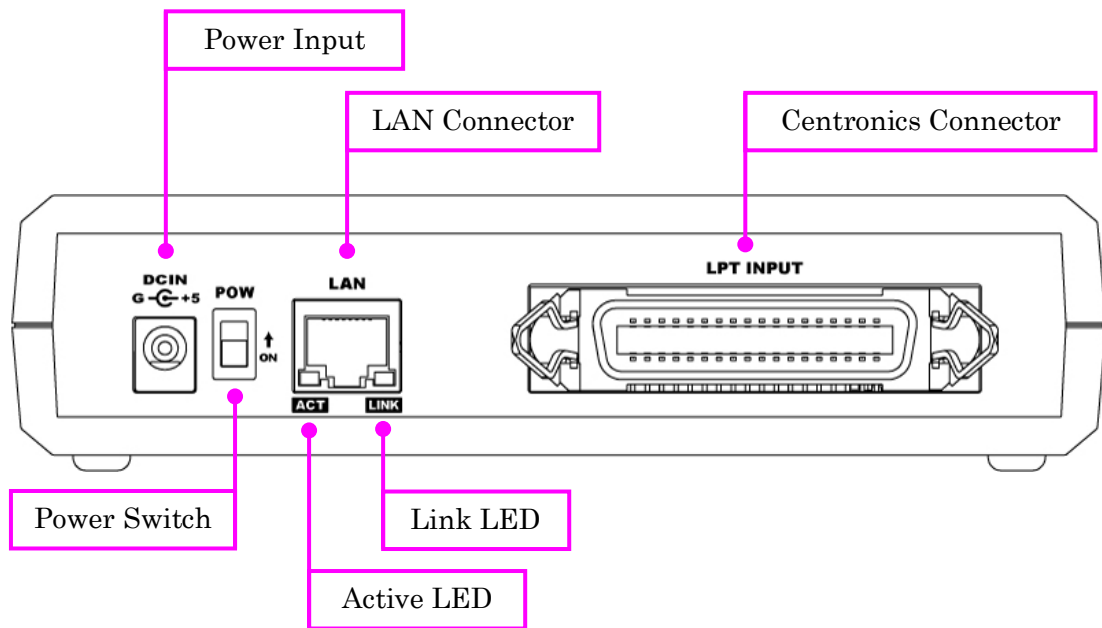

LAN side and Centronics side is isolated.

LEDs

	Name (color)	Function
ACT	Active LED (green)	Turn on during network port communication.
LINK	Link LED (yellow)	Turn on when the power is supplied and LAN cable is connected normally.

4. Specifications

Item	Description	Remarks
Model	LNX-201	
Power	5VDC, Supplied by AC adapter or LAN connector (PoE function)	PoE function supports both mode A and B
Current Consumption	Less than 500mA	
Network Interface	IEEE802.3 (10Base-T) IEEE802.3u (100Base-TX) half-duplex / full-duplex (auto detected)	
LAN Connector	RJ45	ESD protection ± 11 KV isolation over 1500Vrms
Protocol	TCP / UDP / Telnet	
Parallel Input	Centronics Parallel input	TTL
Parallel side Connector	Centronics type 36pin Amphenol connector (female)	
Setting Memory Card	microSD card	For save and restore the product setting
LED	POW: Power LED LPT: Centronics side Status LED LAN: LAN side LED SYS: System Status LED LINK (RJ45 Connector): LINK Status ACT (RJ45 Connector): ACT Status	
Operating Ambient Temp.	-10 to 55 [°C] (14 to 131 [°F])	No condensation permitted
Operating Ambient Humi.	30 to 85 %RH	
Storage Ambient Tem.	-20 to 60 [°C] (-4 to 140 [°F])	
Storage Ambient Humi.	30 to 85 %RH	
Weight	Approx. 270 [g]	Only main body
Dimensions	165 x 80.5 x 39 [mm] (6.496" x 3.169" x 1.535")	Without projections

- * There may be cases that these parts and specifications are changed.
- * Power saving function (suspend, standby, sleep and others) is not supported
- * Please use the microSD card included in the package. SDHC/SDXC is not supported





4.1. AC adapter (Japan's specifications)

Item	Description	Remarks
Input	AC100 to 240V, 50/60Hz 0.45A	
Output	5VDC 2.0A	
Plug	2.1mm inner diameter	Positive Tip
Compatible DC Jack	2.1mm inner diameter	
Operating Ambient Temp.	0 to 40 [°C] (32 to 104 [°F])	No condensation permitted
Operating Ambient Hum.	10 to 90 %RH	
Storage Ambient Temp.	-20 to 80 [°C] (-4 to 176 [°F])	
Storage Ambient Hum.	5 to 95 %RH	
Wire Length	1.6m	
Weight	approx. 70 [g]	
Dimensions	46 x 37 x 22 [mm] 1.811" x 1.457" x 0.866"	Without projections

* This AC adapter is attached for use mainly in Japan. If you use in the other countries, please check the specifications above and plug shape.

* There may be cases that this part and specifications are changed.

4.2. Optional Accessories

Model Name	Image	Description
ACC-027		Attachment for vertical direction JAN: 4937920801096
ACC-028		Attachment for horizontal direction JAN: 4937920801102
ACC-048		Attachment for DIN rail type B JAN: 4937920801829
ACC-036		Neodymium magnet set JAN: 4937920801539

4.3. Power Supply

LNX-201 supports PoE function both A and B type as standard which make it possible to be powered via a LAN cable (PoE compatible HUB is required). It also can be powered by the AC adapter.

5. Connection examples

[LNX-201 single operation]



Capture parallel signal from devices which have general printer interface via a local area network.

[Tunneling mode between LNX-201 and LNX-001]



Capture parallel signal by USB interface from devices which have general printer interface via a local area network. For communication, FTDI virtual COM port and D2XX-API can be used. No need knowledge of network for the programming. LNX-001 is a USB to LAN converter.

[Direct print via LNX-201]



Print Centronics input data directly by relaying the data to LAN printer. To print properly, the input data should be suitable for the printer.

* Please use a cross cable to connect LNX-201 without using a hub.
(LNX-201 does not have a function for AutoMDI/MDI-X.)

6. Setting Tool

LNX SETTING TOOL supports saving and reading network settings from microSD card, or you can also configure the setting over the network. This tool does not require any installation. The application can be downloaded from the CD comes with the product or from our website.

This chapter covers how to read and write the basic setting. For more details, please refer to LNX SETTING TOOL User's Manual in the CD.

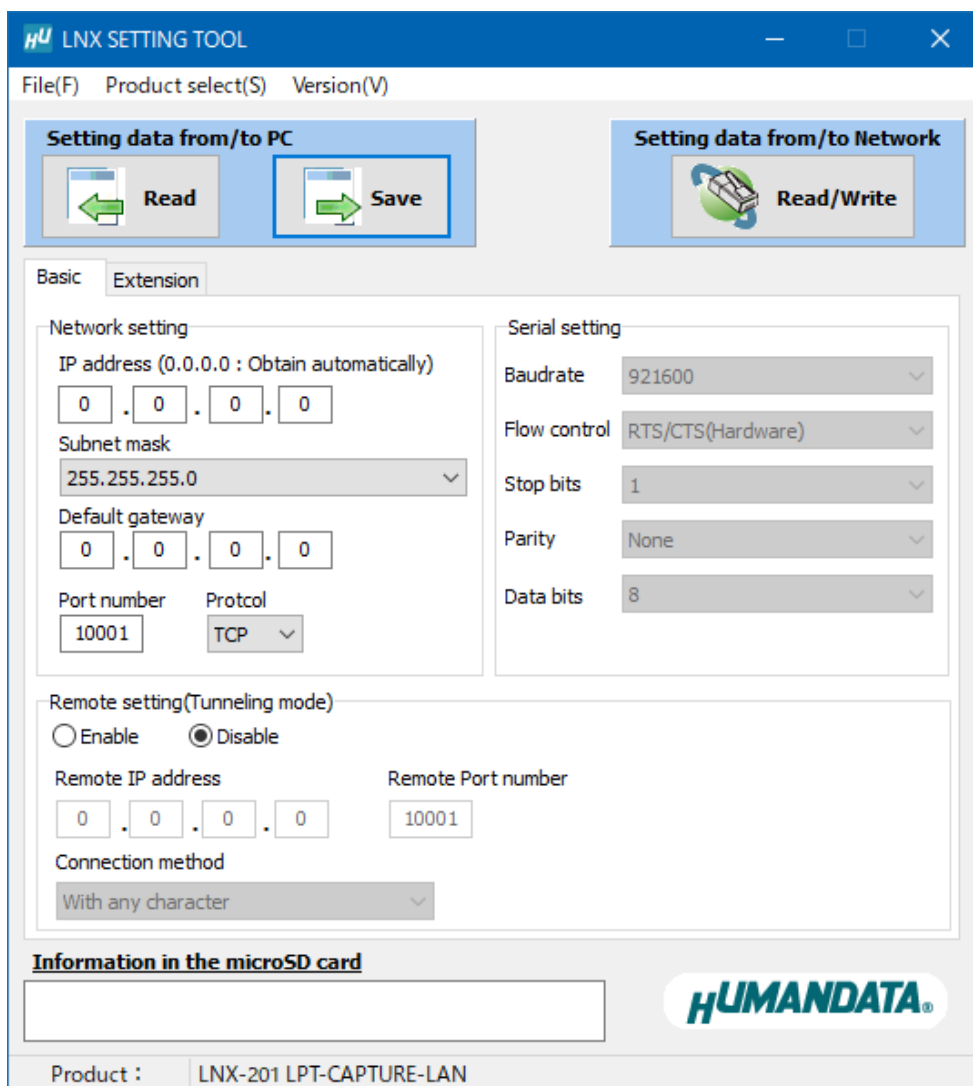

This is a screenshot from version 3.5

6.1. Access Flow of microSD card

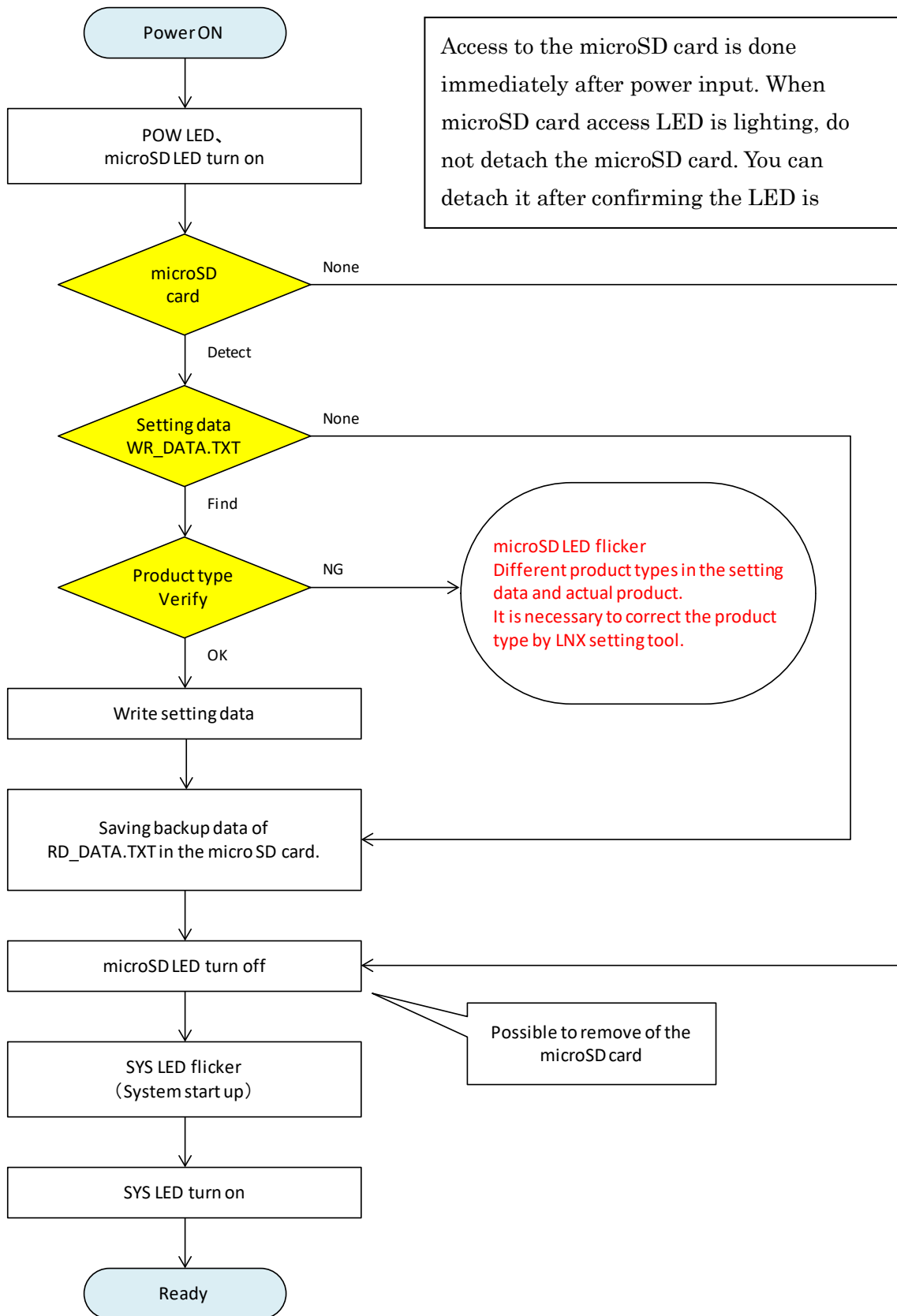

6.2. Write Setting Data

1. Open Setting Tool for LNX series (LNX SETTING TOOL Ver*.*).
2. Select “LNX-201 LPT-CAPTURE-LAN”, and click “OK”.

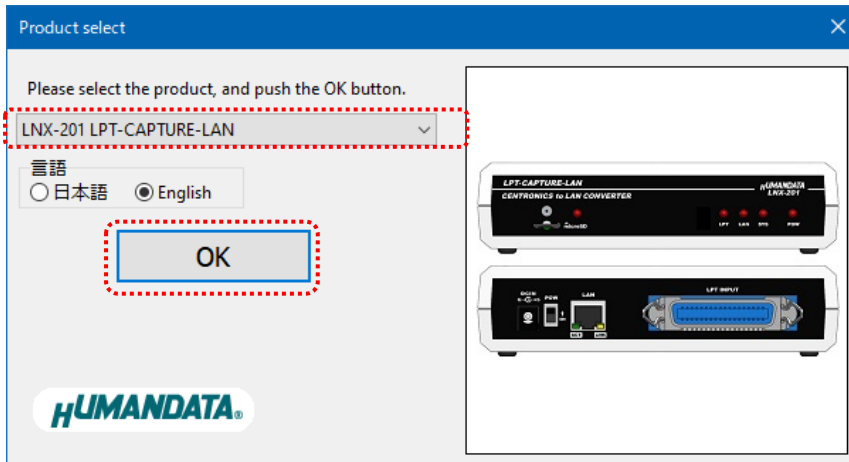

3. Enter the setting such as network or serial.
4. Insert a microSD card to PC (A USB adapter is included with the product)
5. Click “Saving data”.

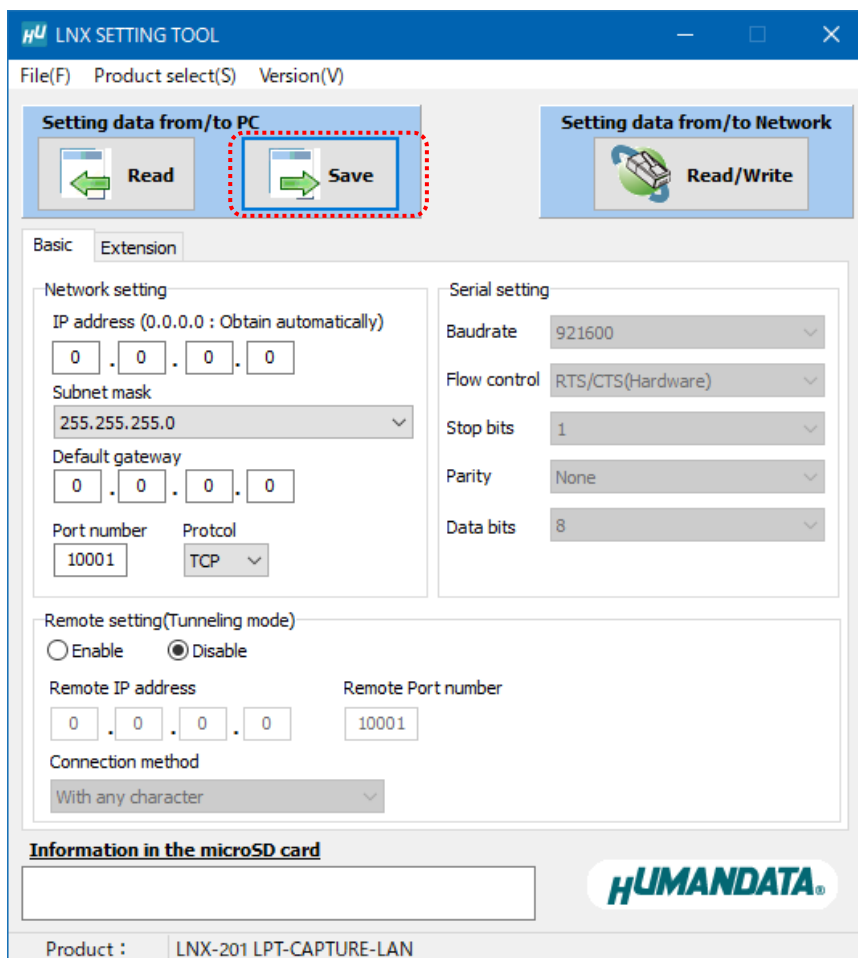

6. Click “OK” in the confirmation dialog.

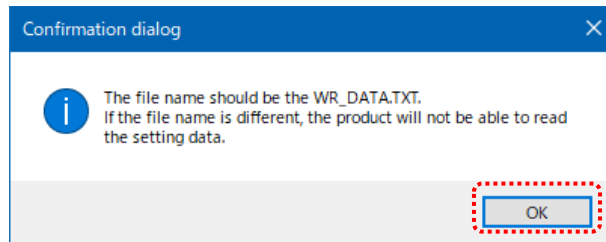

7. Specify the microSD card as saving destination. Please do not change the file name from “WR_DATA.TXT”.
8. Remove the microSD card from PC and insert it to the product. Please confirm that the product power is turned off.
9. When the product is powered on, the setting data is configured to the product automatically. After the data is stored in the product, microSD card is not needed any more. The start-up time can be shortened if the microSD card is removed from the product.

Please be careful not to detach the microSD card before microSD LED is turned off.

6.3. Read Setting Data

1. After confirming the power is off, insert the microSD card to the product.
2. When the product is powered on, the setting data will be reserved to the microSD card automatically. The data file name is “RD_DATA.TXT”.

Please be careful not to detach the microSD card before microSD LED is turned off.

* If there is the same file name in the microSD card, the data will be overwritten.

3. Insert a microSD card to PC (A USB adapter is included with the product)
4. Start the setting tool and click “Reading data”.

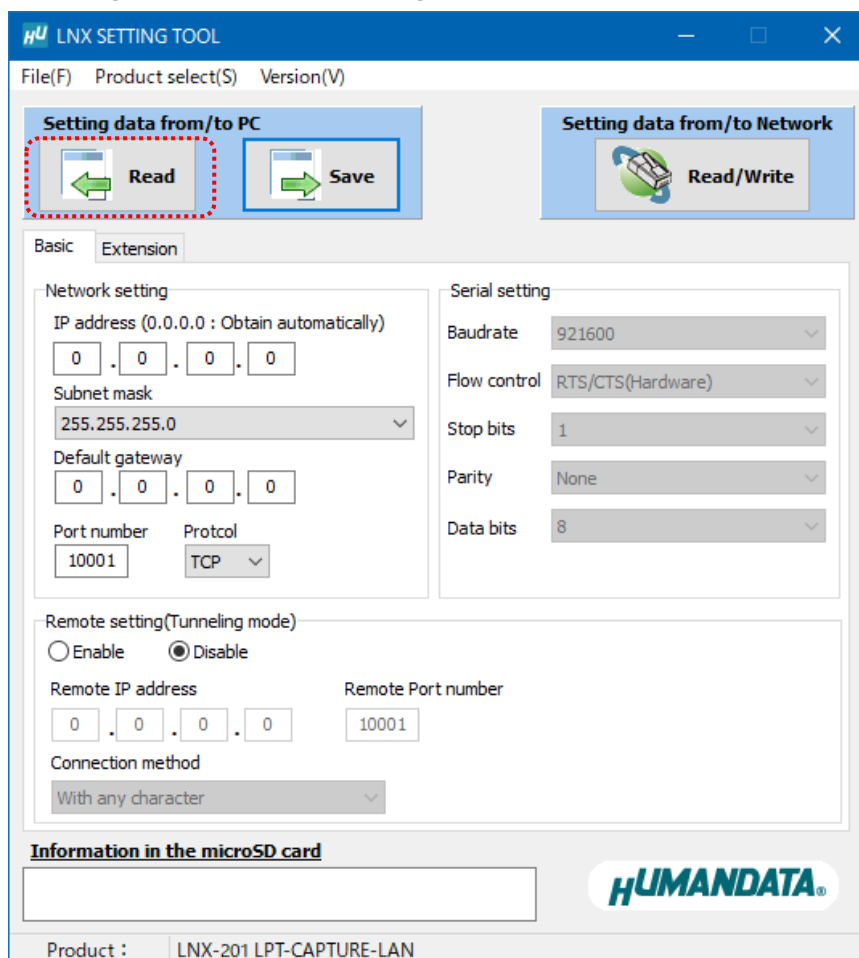

5. Click “OK” in the confirmation dialog.

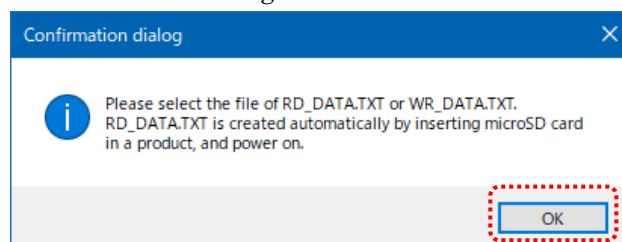

6. Open the “RD_DATA.TXT” in the microSD card.
7. Setting data is loaded.

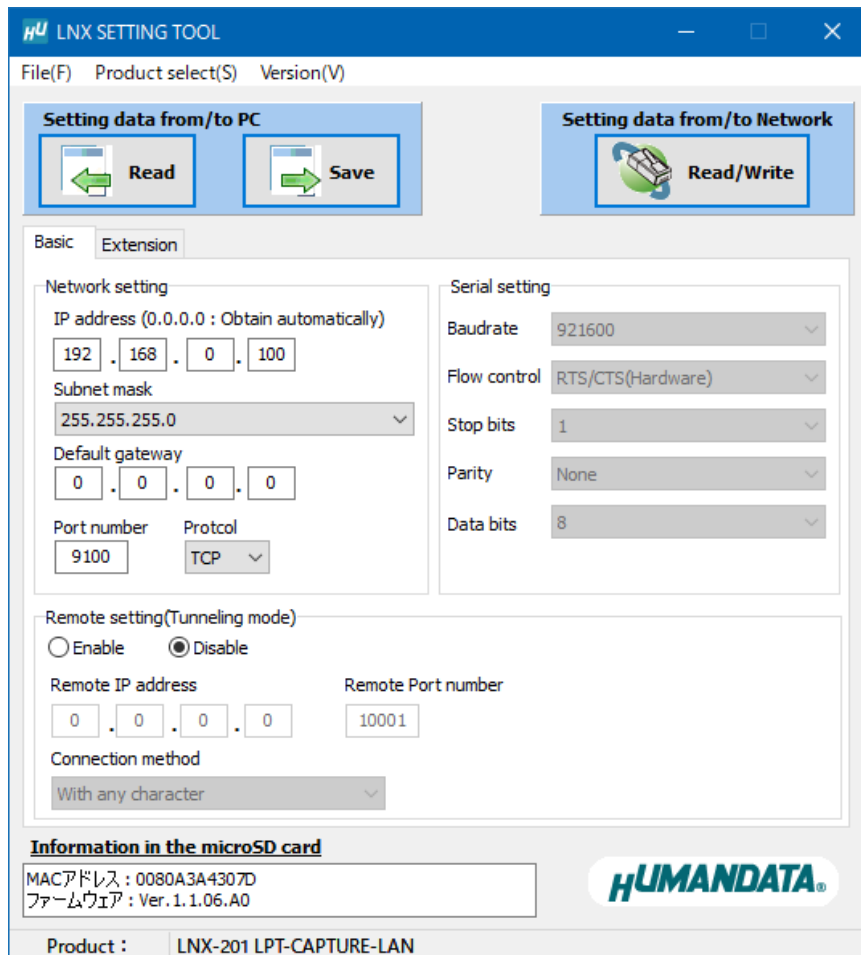

6.4. Write or Read setting data over the network

1. Enter the setting such as network or serial and click “Network”.
 - * Please confirm that microSD card is not inserted in a product.

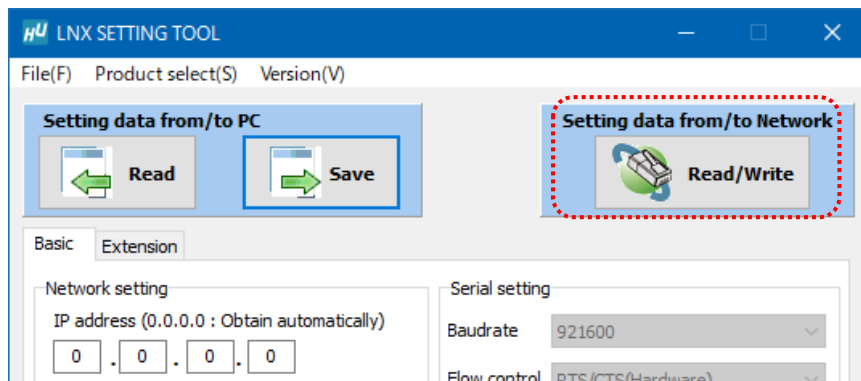

2. Enter an IP address manually or click “Search”. When some products are found, please select a number from a list.

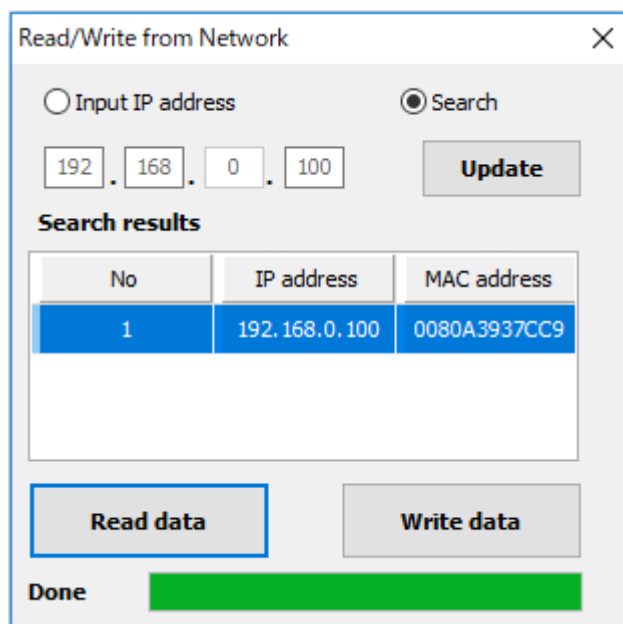

3. Click “Read data” or “Write data”
 - * Even if some devices will be listed in the list and occur process time out. In this case, please change the PCs’ network setting to the same network segment as the product or using microSD card.

6.5. Setting Example

[LNX-201 single operation]



LNX-201

Network Setting	
IP Address	192.168.0.100
Subnet Mask	255.255.255.0
Default Gateway	0.0.0.0
Port Number	10005
Protocol	TCP
Remote IP Address	0.0.0.0
Remote Port Number	0

[Tunneling mode between LNX-201 and LNX-001]



LNX-201		LNX-001	
Network Setting			
192.168.0.100	IP Address	192.168.0.101	
255.255.255.0	Subnet Mask	255.255.255.0	
0.0.0.0	Default Gateway	0.0.0.0	
10005	Port Number	10005	
TCP	Protocol	TCP	
192.168.0.101	Remote IP Address	192.168.0.100	
10005	Remote Port Number	10005	
Serial Communication			
921600	Baud rate	230400	
RTS/CTS (hard ware)	Flow Control	RTS/CTS (hard ware)	
1	Stop Bits	1	
None	Parity	None	
8	Data Bits	8	

* Serial setting of LNX-201 is fixed.

[Direct print via LNX-201]



LNX-201

Network Setting	
IP Address	192.168.0.100
Subnet Mask	255.255.255.0
Default Gateway	0.0.0.0
Port Number	10005
Protocol	TCP
Remote IP Address	192.168.0.101
Remote Port Number	9100

7. Virtual COM Port

You can use the software that creates Virtual COM ports on your PC. You can use the COM port to communicate to an IP address of LNX-201. Rather than going out the local port, the data is transmitted across the Ethernet network using TCP/IP. LNX-201 attached to the network receives the data and transfers it from its own serial port to the attached equipment.

For more details about the application, please refer to the "CPR_Manager" folder in the CD-ROM bundled with the product. There is the download link for the application in that folder.

8. Additional Documentation and User Support

The following documents and other supports are available at

<https://www.hdl.co.jp/en/faspc/LNX/lrx-201>

- LNX SETTING TOOL
 - Outline Drawing
- ... and more.

9. Warranty and Compensation

Please refer to the following URL for the warranty.

<https://www.fa.hdl.co.jp/en/fa-warranty.html>

LPT-CAPTURE-LAN

LNX-201

User's Manual

Ver. 1.2 March 11, 2026

HuMANDATA LTD.

Address: 1-2-10-2F, Nakahozumi, Ibaraki
Osaka, Japan
ZIP 567-0034

Tel: 81-72-620-2002 (Japanese)

Fax: 81-72-620-2003 (Japanese/English)

URL: <https://www.fa.hdl.co.jp> (Japan)

<https://www.fa.hdl.co.jp/en> (Global)
