

TOP LAYER

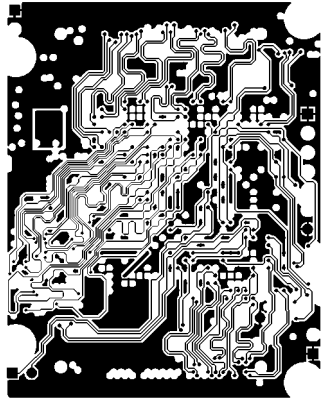

MID LAYER1

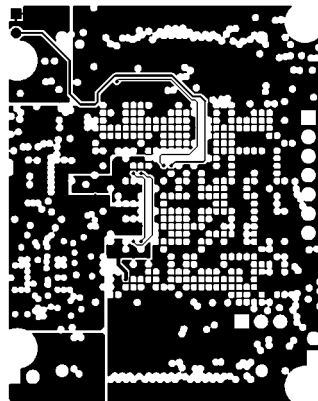

MID LAYER2

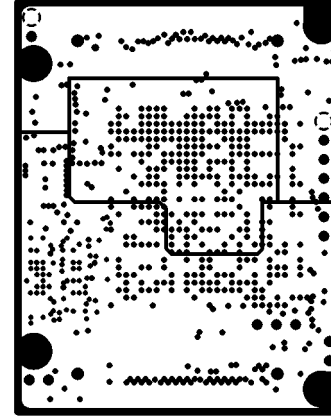

INTERNAL PLANE2

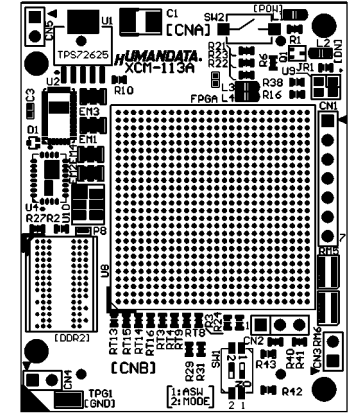

Component Side

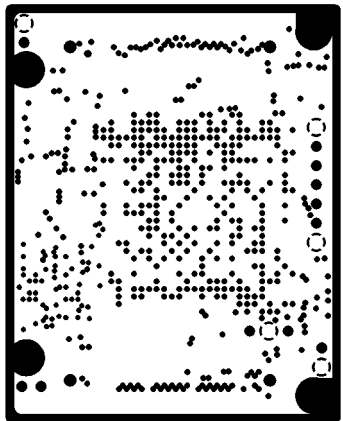

INTERNAL PLANE1

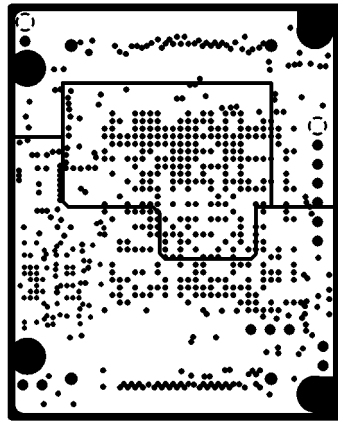

INTERNAL PLANE3

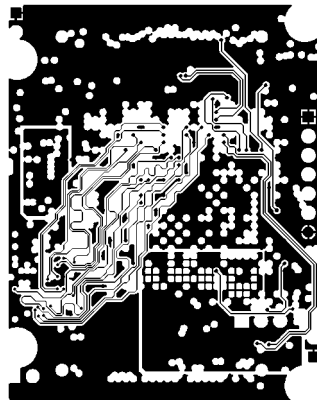

MID LAYER3

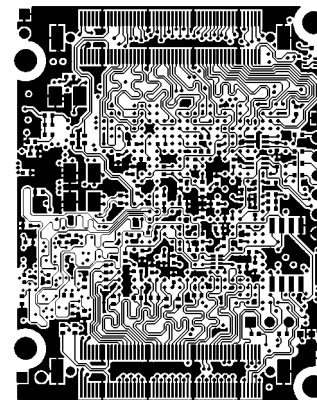

BOTTOM LAYER

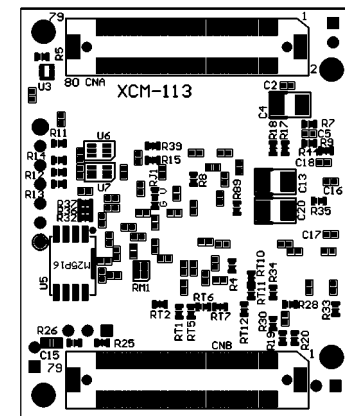

Solder Side

<b>HUMANDATA</b>		UNIT	TITLE	
CHK	DWG		XCM-113A PCB drawing	
		SIZE	DWG NO	REV
			PCB-XCM-113A	A