

**BANK A**

**BANK B**

**BANK B**

**BANK A**

XCM110ZR1-SCH-B2.pdf



**HUMAN DATA**  
HuMANDATA LTD.  
OSAKA JAPAN  
www.hdl.co.jp/en/(Global)  
www.hdl.co.jp/(Japan)

**SPARTAN-6 FG484 FPGA Board**

Date:	29-Jul-2013	11:38:19	File:	XCM110B.sch	Sheet	1	of	2
DOC. No.	XCM-110Z					B2		

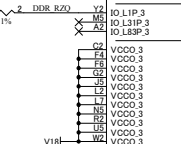
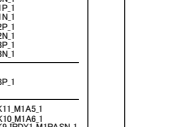
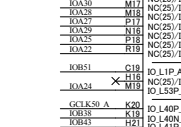
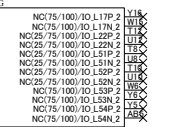
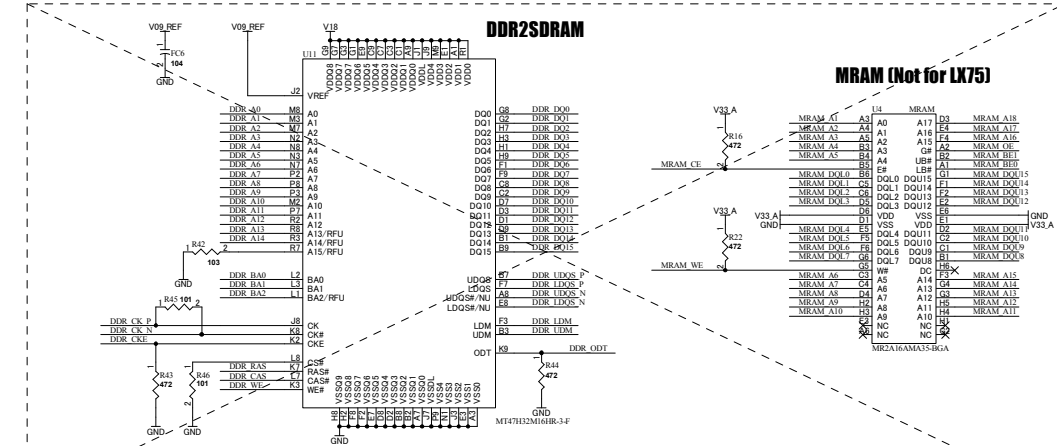
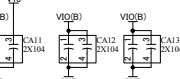
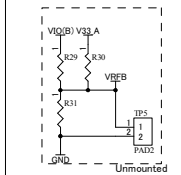
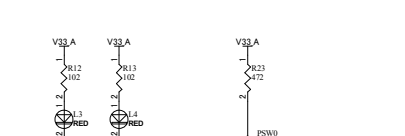
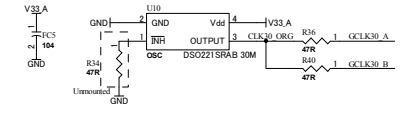
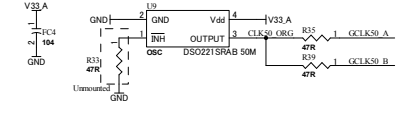
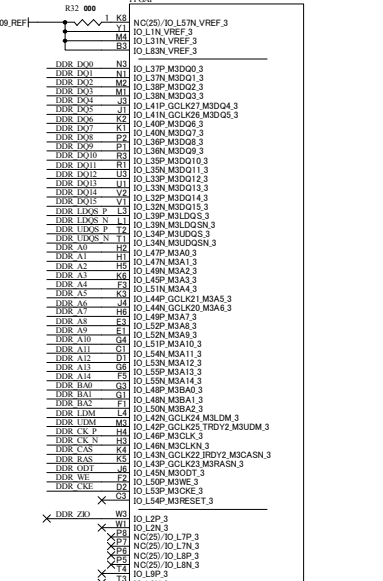
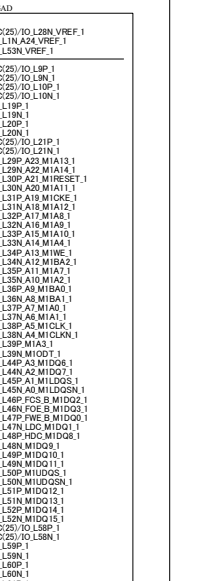
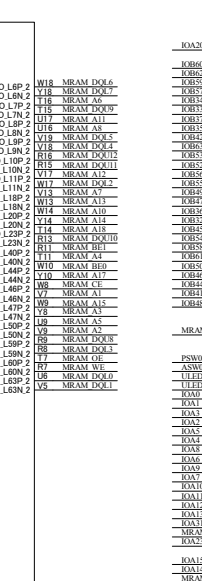
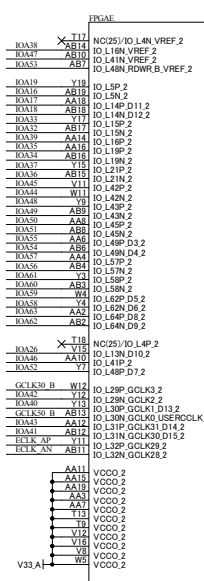
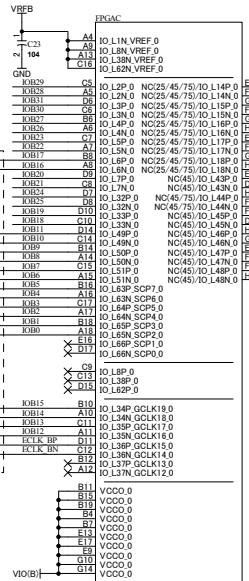
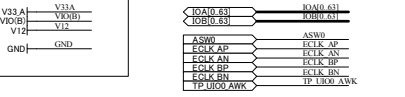

XCM1102R1-SCH-B2.pdf

**HUMANDATA**  
 HuMANDATA LTD.  
 OSAKA JAPAN  
 www.hdl.co.jp/en/(Global)  
 www.hdl.co.jp/(Japan)  
 Date: 29-Jul-2013 11:38:20

**SPARTAN-6 FG484 FPGA Board**

DOC. No.	XCM-110Z	B2
File:	IO.sch	Sheet 2 of 2