

V18 V18
V10 V10
V25 V25
GND GND
V33A V33A
VIO(B) VIO(B)

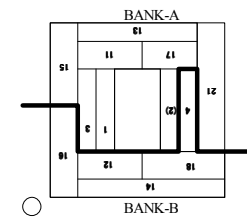
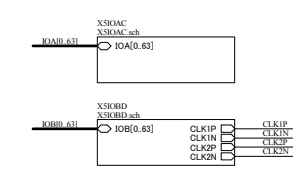
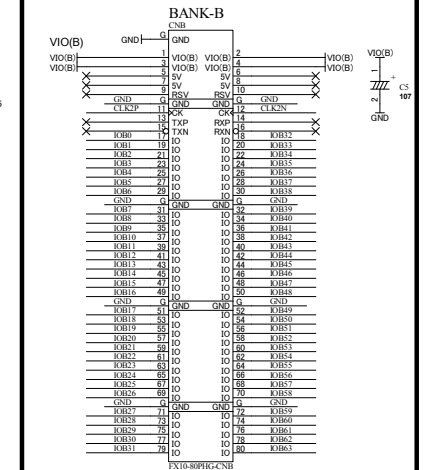
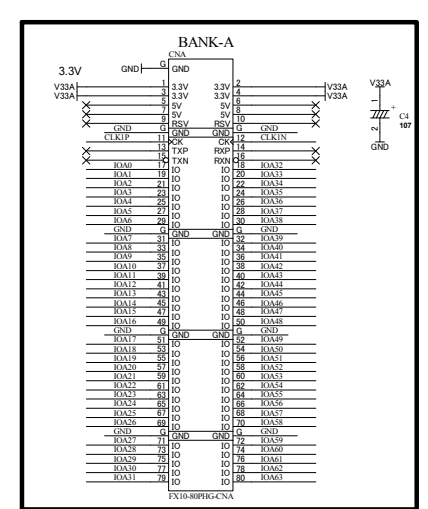
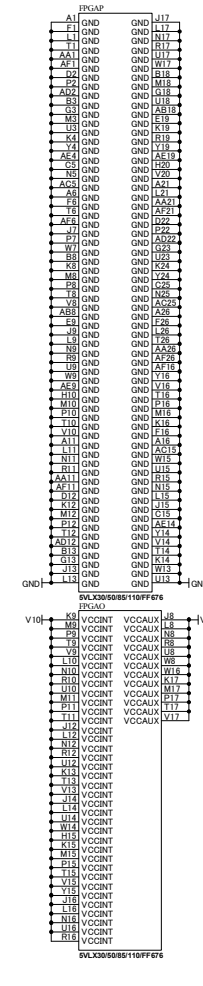
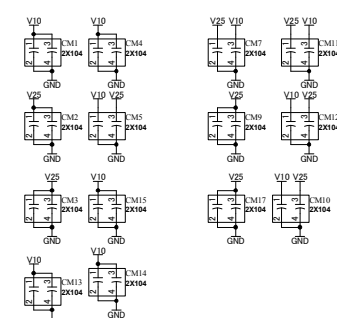
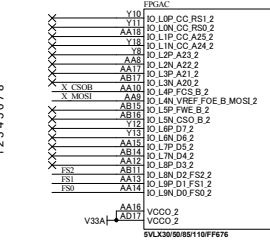
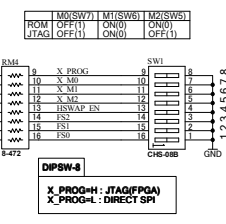
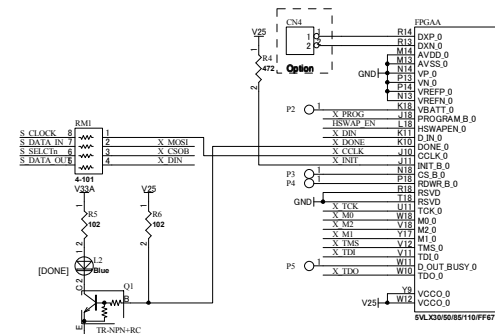
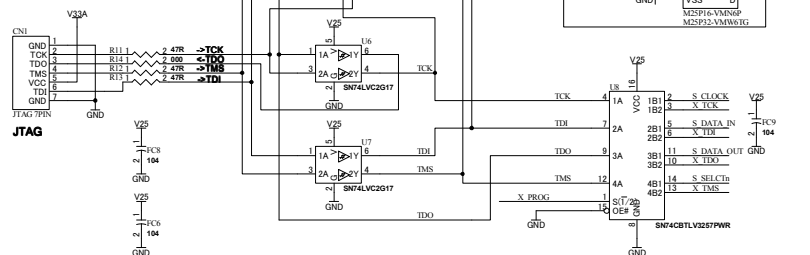
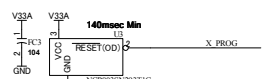
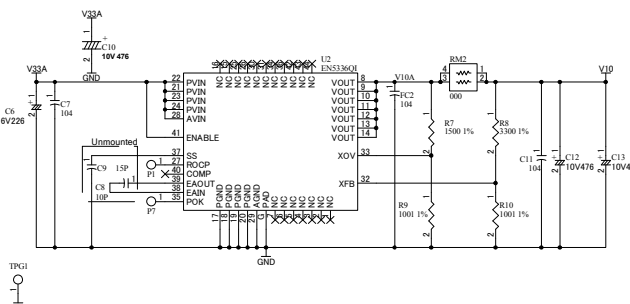
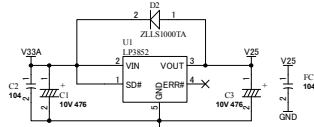
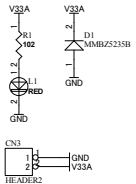

XCM109R1-SCH-A5.pdf

Doc No: **XCM-109**

FILE: XCM109A3.ach DATE: 22-May-2017 11:01:48 Sheet: 1 / 3

Virtex-5 FFG676 FPGA Board

A5

V18 V18
V19 V19
V20 V20
GND GND
V31A V31A
V31B V31B
V31C V31C

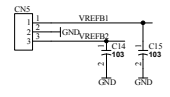

CNB

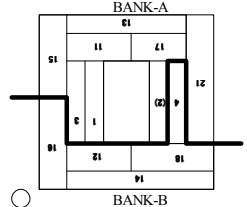
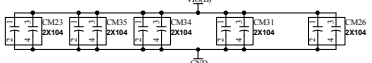
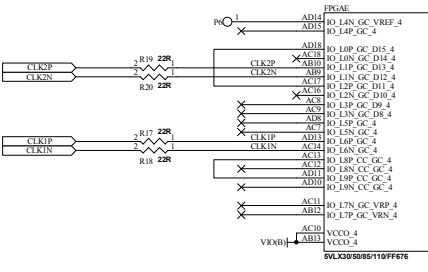
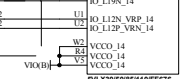
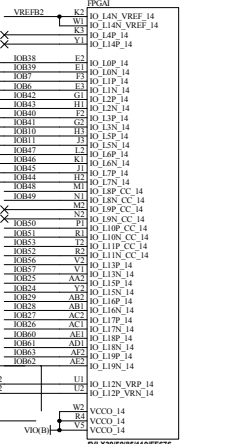
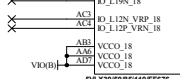
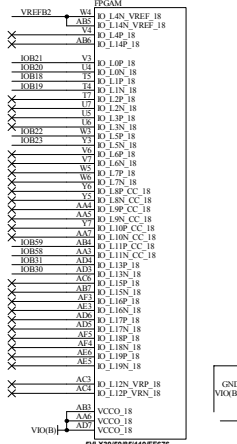
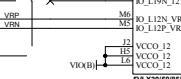
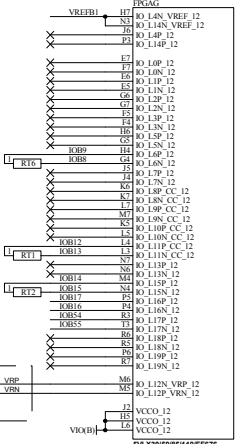
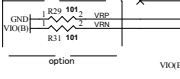
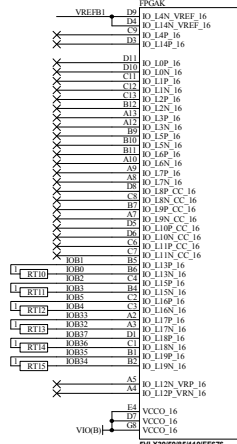

HUMAN DATA
HUMAN DATA LTD.
www.hdi.co.jp

DSN	TITLE	XCM-109	
	Virtex-5 FFG676 FPGA Board		
DOC No.		XCM-109	A5
FILE: XSI0BD.sch	DATE: 22-May-2017 11:01:49	3 / 3	