

V18 V18
V10 V10
V25 V25
GND GND
V33A V33A
VIO(B) VIO(B)

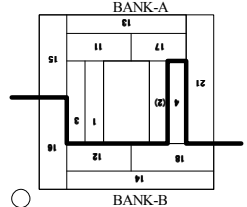
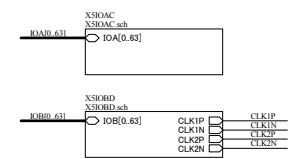
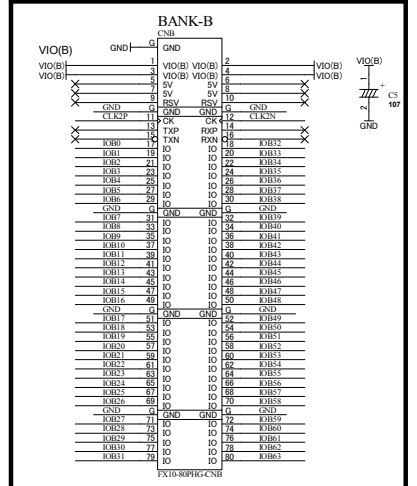
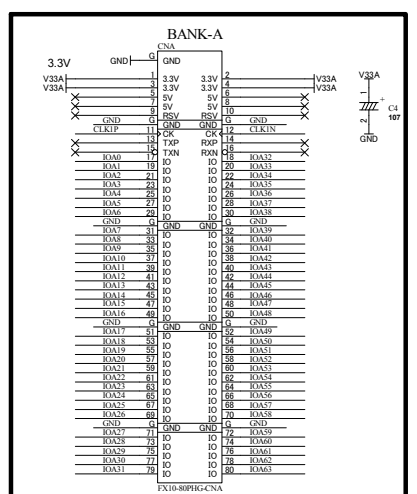
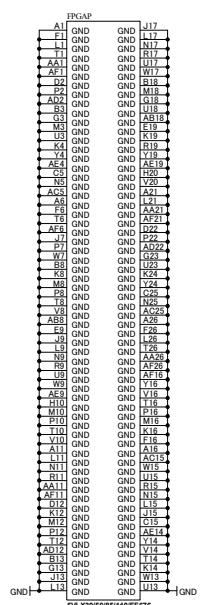
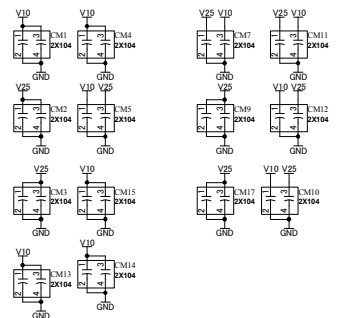
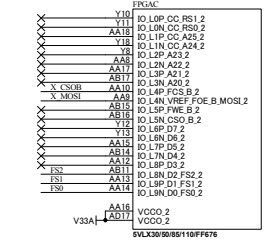
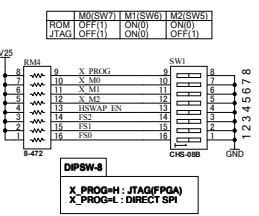
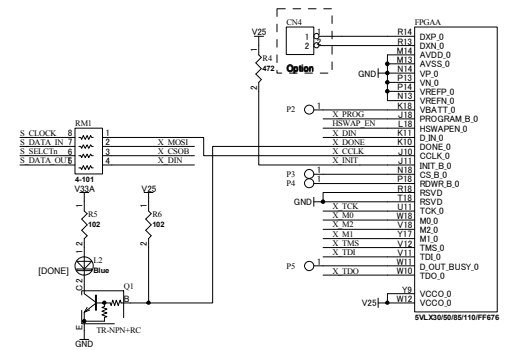
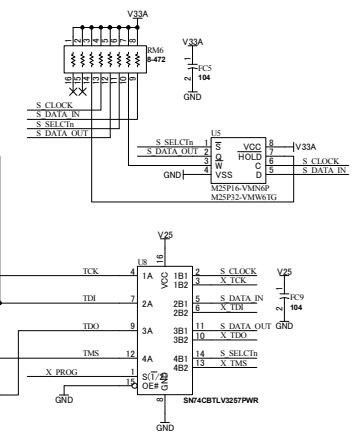
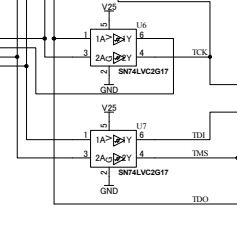
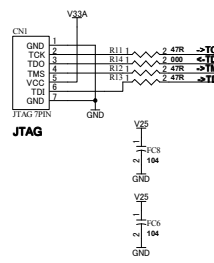
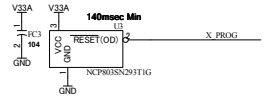
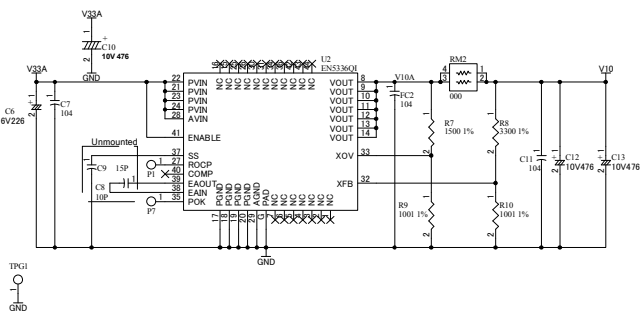
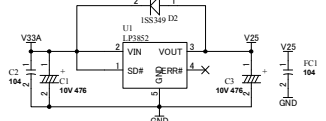
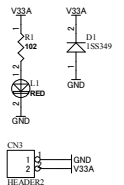

HuMANDATA LTD.
OSAKA JAPAN
www.hdl.co.jp/en/(Global)
www.hdl.co.jp/(Japan)

Virtex-5 FFG676 FPGA Board

DOC. No. XCM-109

Date: 11-May-2012 09:52:03

XCM109R1-SCH-A4.pdf

File: XCM109A3.sch

Sheet 1 of 3

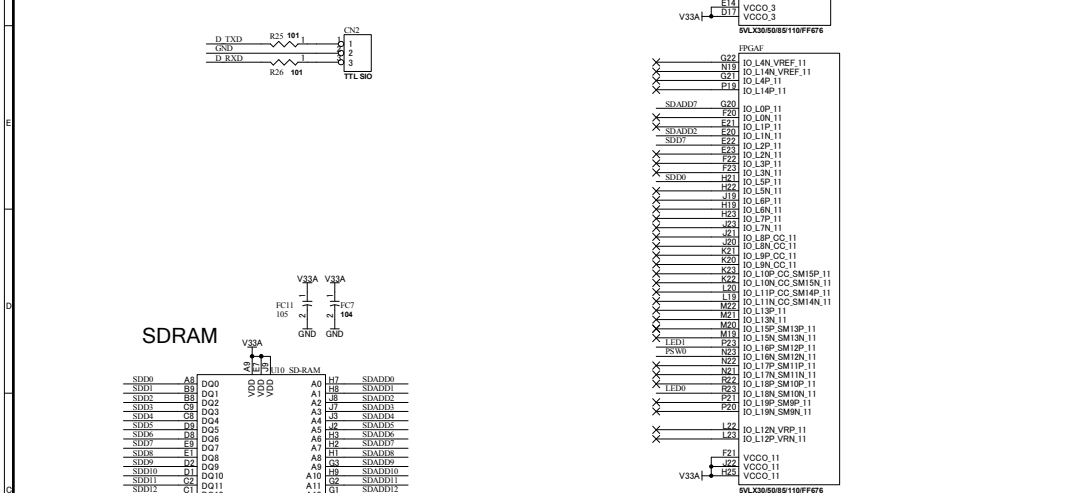
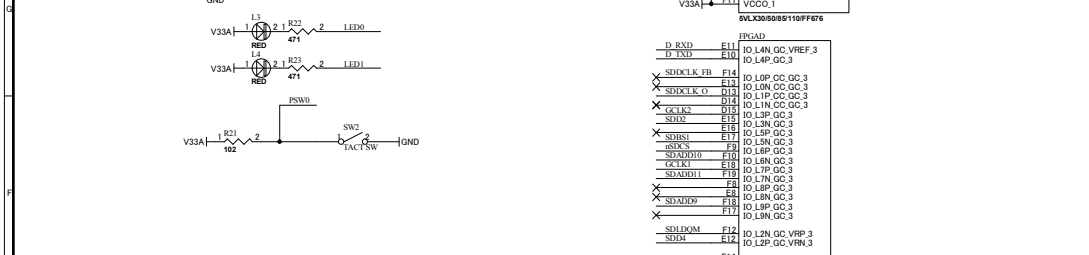
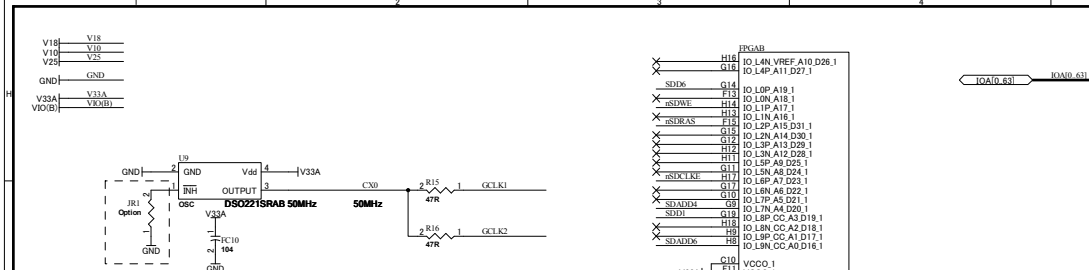

IOAD0, G1		
X	H10	IO L4N.VREF, A10, D08, 1
X	G16	IO L4P, A11, D27, 1
X	SD06	G14
X	F13	IO LOP, A19, 1
X	SD06	IO LON, A18, 1
X	SD06	IO LIP, A17, 1
X	SD06	IO L1N, A16, 1
X	SD06	IO L2N, A14, D30, 1
X	SD06	IO L3P, A13, D28, 1
X	SD06	IO L2N, A12, D26, 1
X	SD06	IO L3P, A8, D25, 1
X	H11	IO L8N, A4, D23, 1
X	SD06	IO L8P, A7, D23, 1
X	SD06	IO L8N, A4, D23, 1
X	SD06	IO L1P, A5, D21, 1
X	SD06	IO L1N, A4, D20, 1
X	SD06	IO L8P, CC, A3, D19, 1
X	H16	IO L8N, CC, A2, D18, 1
X	SD06	IO L8P, CC, A1, D17, 1
X	SD06	IO L8N, CC, A0, D16, 1
X	G10	VCCO, 1
X	F11	VCCO, 1

IOAD1, G1		
X	H10	IO L4N.VREF, A10, D08, 1
X	G16	IO L4P, A11, D27, 1
X	SD06	G14
X	F13	IO LOP, A19, 1
X	SD06	IO LON, A18, 1
X	SD06	IO LIP, A17, 1
X	SD06	IO L1N, A16, 1
X	SD06	IO L2N, A14, D30, 1
X	SD06	IO L3P, A13, D28, 1
X	SD06	IO L2N, A12, D26, 1
X	SD06	IO L3P, A8, D25, 1
X	H11	IO L8N, A4, D23, 1
X	SD06	IO L8P, A7, D23, 1
X	SD06	IO L8N, A4, D23, 1
X	SD06	IO L1P, A5, D21, 1
X	SD06	IO L1N, A4, D20, 1
X	SD06	IO L8P, CC, A3, D19, 1
X	H16	IO L8N, CC, A2, D18, 1
X	SD06	IO L8P, CC, A1, D17, 1
X	SD06	IO L8N, CC, A0, D16, 1
X	G10	VCCO, 1
X	F11	VCCO, 1

IOAD2, G1		
X	H10	IO L4N.VREF, A10, D08, 1
X	G16	IO L4P, A11, D27, 1
X	SD06	G14
X	F13	IO LOP, A19, 1
X	SD06	IO LON, A18, 1
X	SD06	IO LIP, A17, 1
X	SD06	IO L1N, A16, 1
X	SD06	IO L2N, A14, D30, 1
X	SD06	IO L3P, A13, D28, 1
X	SD06	IO L2N, A12, D26, 1
X	SD06	IO L3P, A8, D25, 1
X	H11	IO L8N, A4, D23, 1
X	SD06	IO L8P, A7, D23, 1
X	SD06	IO L8N, A4, D23, 1
X	SD06	IO L1P, A5, D21, 1
X	SD06	IO L1N, A4, D20, 1
X	SD06	IO L8P, CC, A3, D19, 1
X	H16	IO L8N, CC, A2, D18, 1
X	SD06	IO L8P, CC, A1, D17, 1
X	SD06	IO L8N, CC, A0, D16, 1
X	G10	VCCO, 1
X	F11	VCCO, 1

IOAD3, G1		
X	H10	IO L4N.VREF, A10, D08, 1
X	G16	IO L4P, A11, D27, 1
X	SD06	G14
X	F13	IO LOP, A19, 1
X	SD06	IO LON, A18, 1
X	SD06	IO LIP, A17, 1
X	SD06	IO L1N, A16, 1
X	SD06	IO L2N, A14, D30, 1
X	SD06	IO L3P, A13, D28, 1
X	SD06	IO L2N, A12, D26, 1
X	SD06	IO L3P, A8, D25, 1
X	H11	IO L8N, A4, D23, 1
X	SD06	IO L8P, A7, D23, 1
X	SD06	IO L8N, A4, D23, 1
X	SD06	IO L1P, A5, D21, 1
X	SD06	IO L1N, A4, D20, 1
X	SD06	IO L8P, CC, A3, D19, 1
X	H16	IO L8N, CC, A2, D18, 1
X	SD06	IO L8P, CC, A1, D17, 1
X	SD06	IO L8N, CC, A0, D16, 1
X	G10	VCCO, 1
X	F11	VCCO, 1

IOAD4, G1		
X	H10	IO L4N.VREF, A10, D08, 1
X	G16	IO L4P, A11, D27, 1
X	SD06	G14
X	F13	IO LOP, A19, 1
X	SD06	IO LON, A18, 1
X	SD06	IO LIP, A17, 1
X	SD06	IO L1N, A16, 1
X	SD06	IO L2N, A14, D30, 1
X	SD06	IO L3P, A13, D28, 1
X	SD06	IO L2N, A12, D26, 1
X	SD06	IO L3P, A8, D25, 1
X	H11	IO L8N, A4, D23, 1
X	SD06	IO L8P, A7, D23, 1
X	SD06	IO L8N, A4, D23, 1
X	SD06	IO L1P, A5, D21, 1
X	SD06	IO L1N, A4, D20, 1
X	SD06	IO L8P, CC, A3, D19, 1
X	H16	IO L8N, CC, A2, D18, 1
X	SD06	IO L8P, CC, A1, D17, 1
X	SD06	IO L8N, CC, A0, D16, 1
X	G10	VCCO, 1
X	F11	VCCO, 1

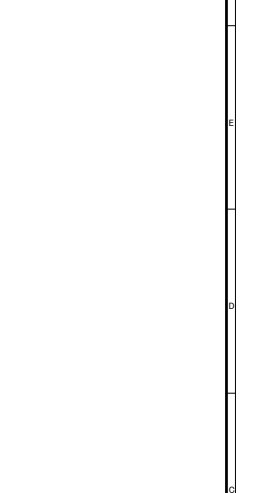

HUMAN DATA

HuMANDATA LTD.
OSAKA JAPAN
www.hdl.co.jp/en/(Global)
www.hdl.co.jp/(Japan)

Virtex-5 FFG676 FPGA Board

DOC. No. XCM-109
Sheet 2 of 3

Date: 11-May-2012 09:52:04 File: XSIOAC.sch

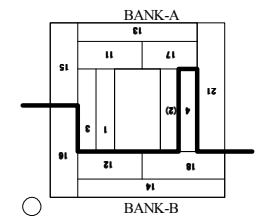

V18| V18
 V10| V22
 V20| V20
 GND| GND
 V33A| V33A
 VIO(B)| VIO(B)

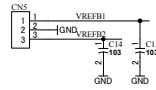

CNB

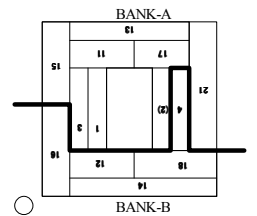
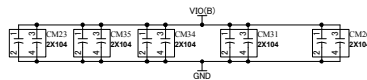
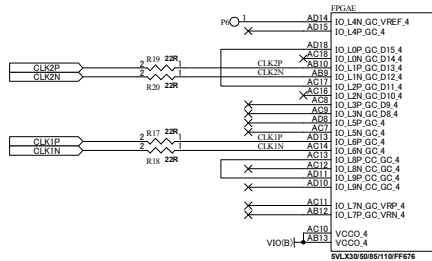
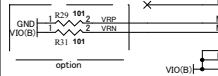
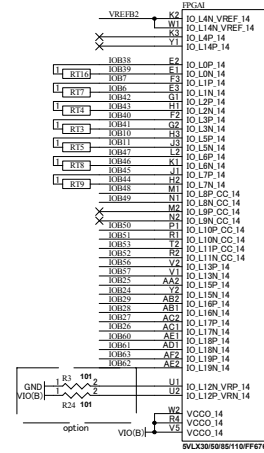
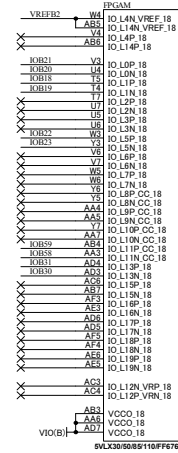
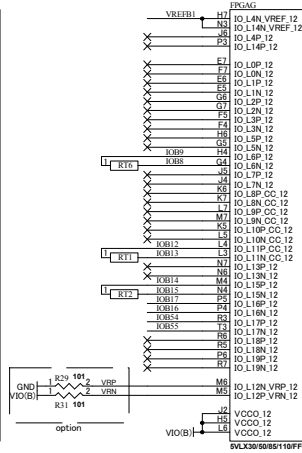
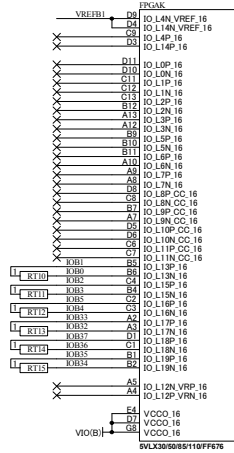
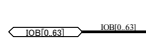

XCM109R1-SCH-A4.pdf

	Virtex-5 FFG676 FPGA Board	
	HuMANDATA LTD. OSAKA JAPAN www.hdl.co.jp/en/ (Global) www.hdl.co.jp/ (Japan)	DOC. No. XCM-109
Date: 11-May-2012 09:52:04	File: XSIOBD.sch	Sheet 3 of 3