

TOP LAYER

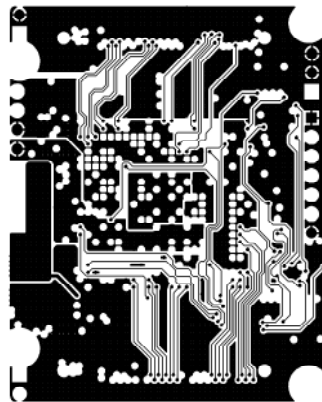

MID LAYER1

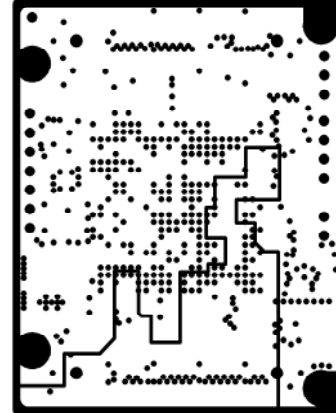

INTERNAL PLANE2(VCC)

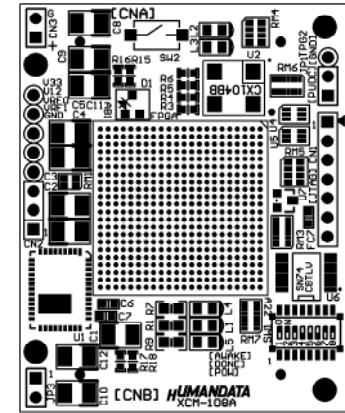

部品面

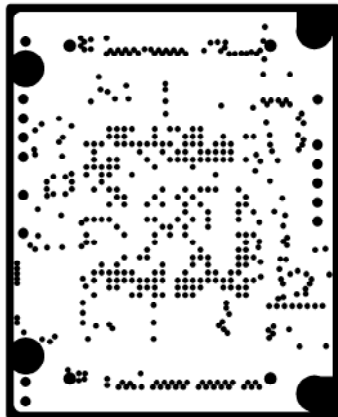

INTERNAL PLANE1(GND)

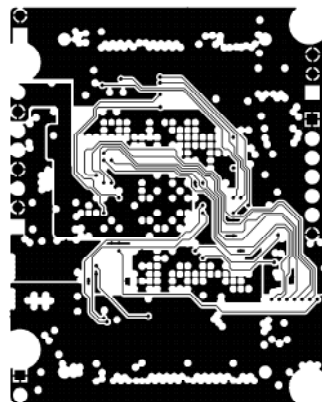

MID LAYER2

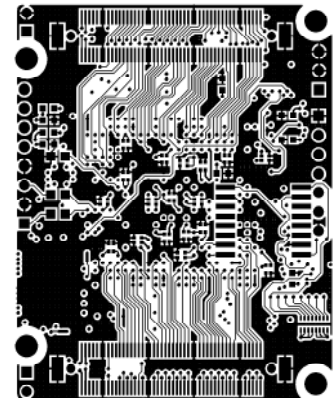

BOTTOM LAYER

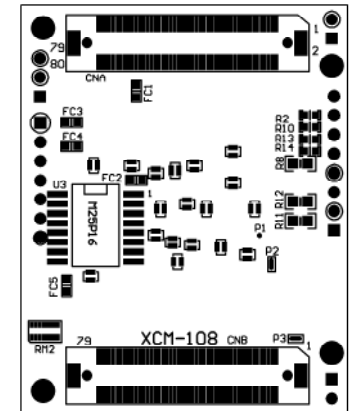

はんだ面

<b>HUMANDATA</b>		UNIT	TITLE	
CHK	DWG	SIZE	XCM-108Aパターン図	
			DWG NO	REV
			XCM-108A.ART	A

