

V33A	V33A
V33B	V33B
VCCINT_10	VCCINT_10
VMTGTVCC_10	VMTGTVCC_10
VMTGTVTT_12	VMTGTVTT_12
VMTGTVCCAU18_18	VMTGTVCCAU18_18
VCCAU18	VCCAU18
VCCADC_18	VCCADC_18
VCCAUX_18	VCCAUX_18
VCCOA	VCCOA
VCCOB	VCCOB
VCCOR	VCCOR
GND	GND

[POWER]

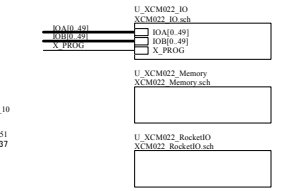
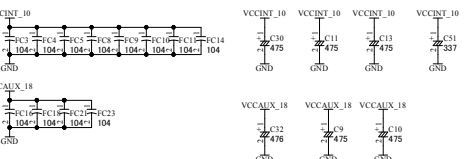
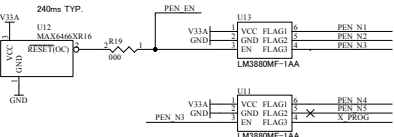
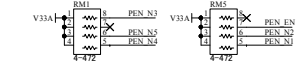
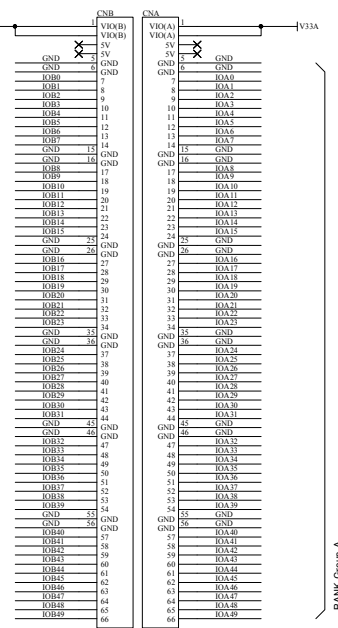
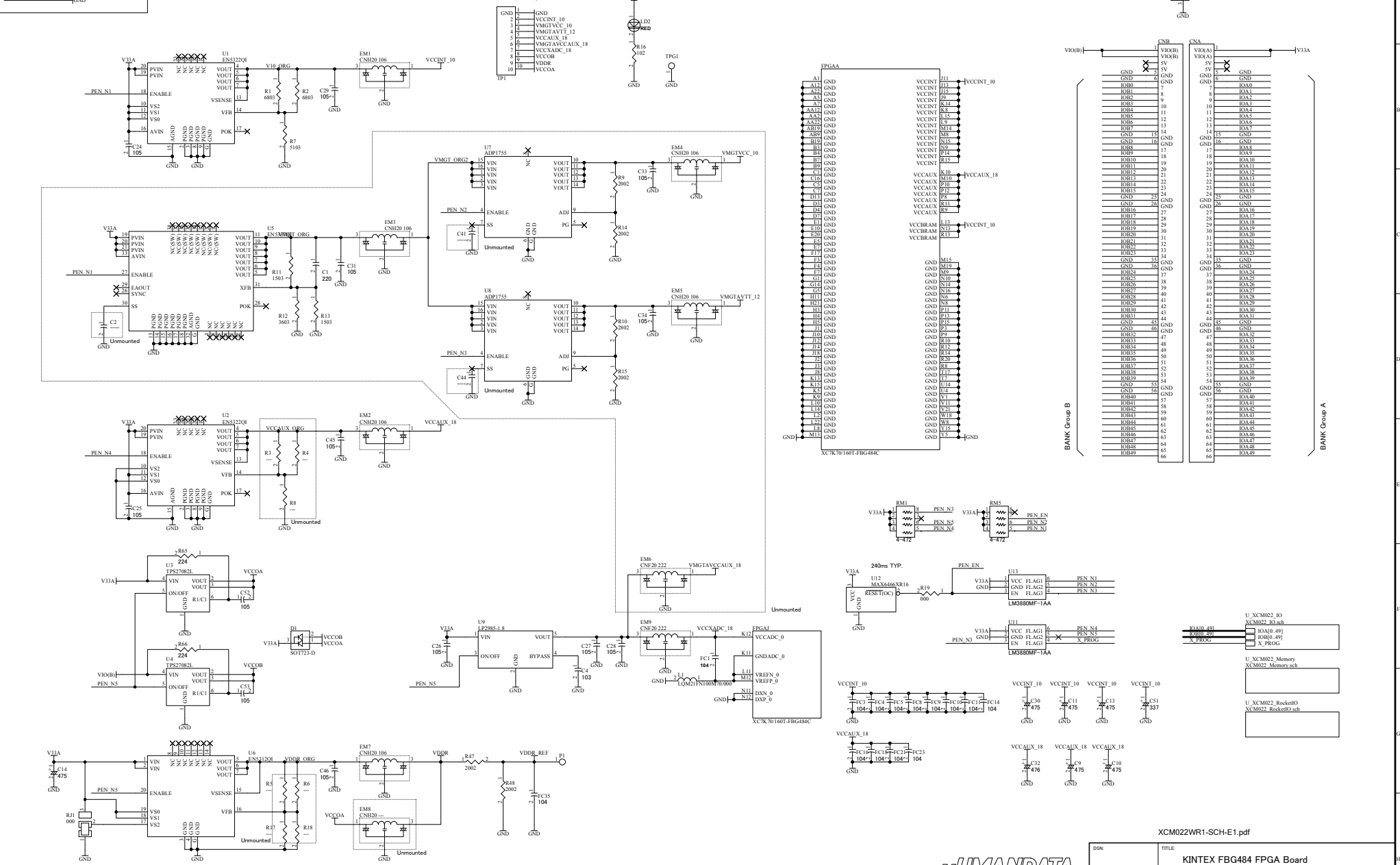

XCM022WR1-SCH-E1.pdf

DSN	TITLE	KINTEX FBG484 FPGA Board
DOC No.	XCM-022W	E1
FILE: XCM022W.sch	DATE: 2017/10/23 15:13:24	Sheet 1 / 4

V33A	V33A
VFB0	VFB0
VCCINT_10	VCCINT_10
VMG1VCC_10	VMG1VCC_10
VMG1VTT_12	VMG1VTT_12
VMG1AVCCAUX_18	VMG1AVCCAUX_18
VCCAUX_18	VCCAUX_18
VCCAUX_18	VCCAUX_18
VCCAUX_18	VCCAUX_18
VCCOA	VCCOA
VCCOB	VCCOB
GND	GND

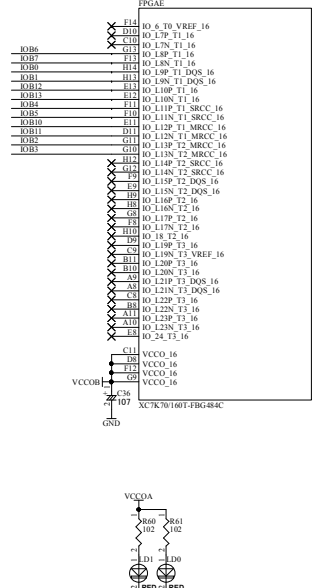
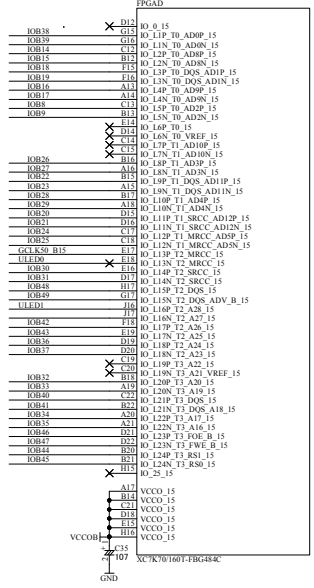

BANK Group B

BANK Group A

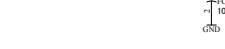
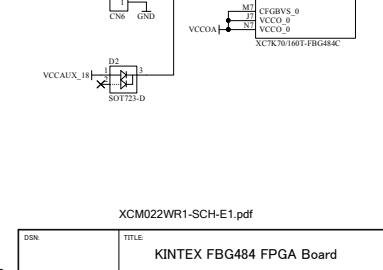
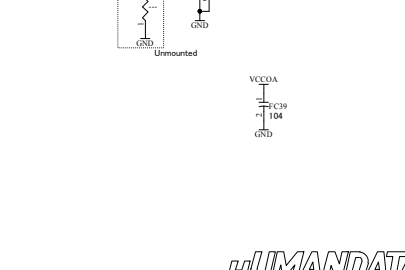
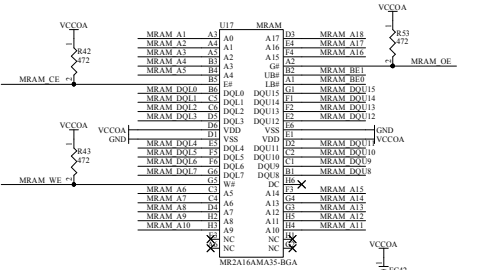
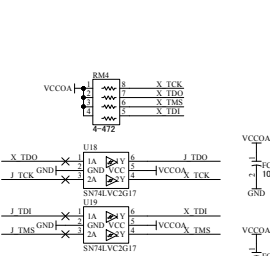
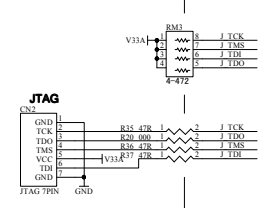
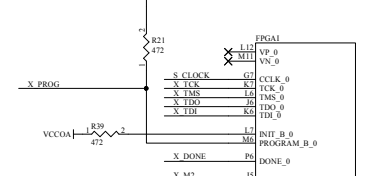
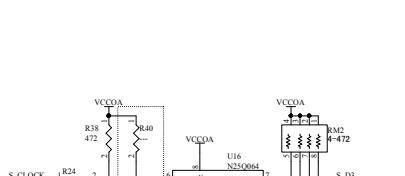
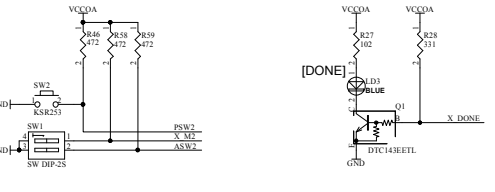
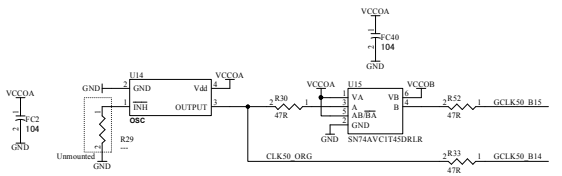
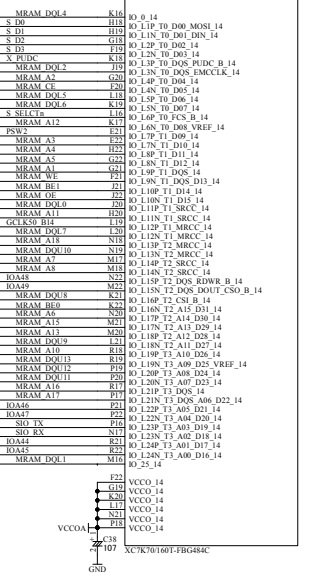
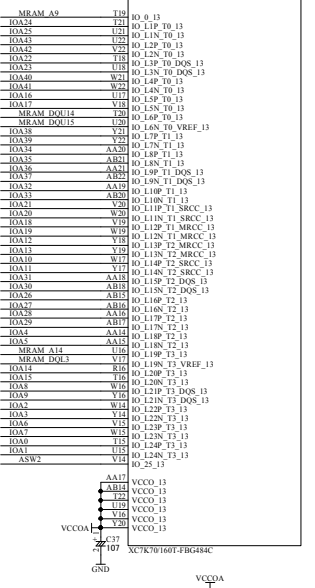

XCM022WR1-SCH-E1.pdf

KINTEX FBG484 FPGA Board

DOC No: **XCM-022W**

FILE: XCM022IO.sch DATE: 2017/10/23 15:13:24 Sheet: **2 / 4**

E1

V33A	V33A
VFB0	VFB0
VCCINT_10	VCCINT_10
VMGT1VCC_10	VMGT1VCC_10
VMGTAVT1_12	VMGTAVT1_12
VMGTAVCCAU_X_18	VMGTAVCCAU_X_18
VCCAU_X_18	VCCAU_X_18
VCCXADC_18	VCCXADC_18
V33A	V33A
VCCOA	VCCOA
VCCOB	VCCOB
VCCOC	VCCOC
VCCOD	VCCOD
GND	GND

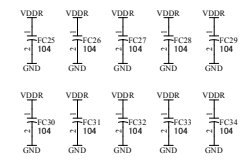
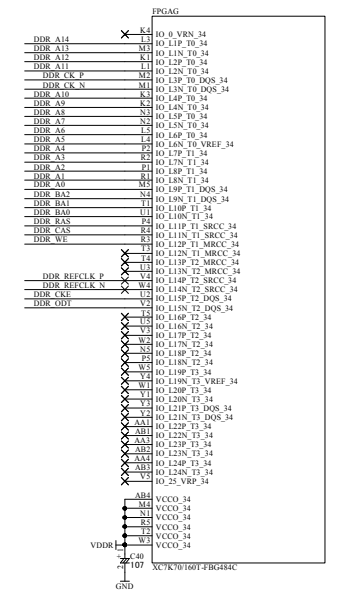
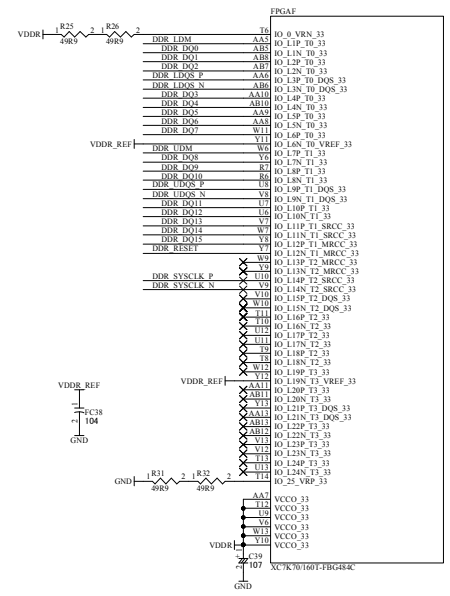
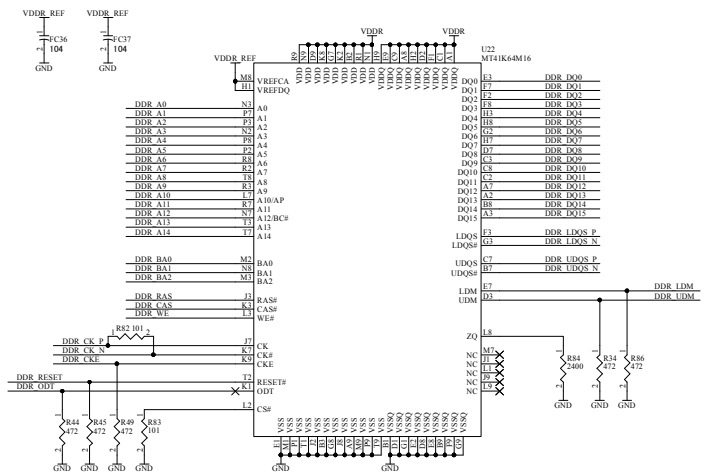
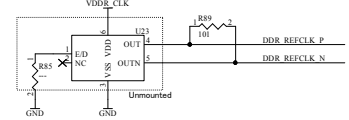
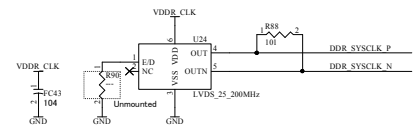
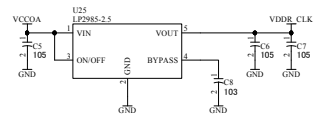

DSN	TITLE	XCM022WR1-SCH-E1.pdf	
		KINTEX FBG484 FPGA Board	
DOC No.	XCM-022W	E1	
FILE	XCM022Memory.sch	DATE	2017/10/23 15:13:25
		Sheet	3 / 4

V33A	V33A
V33B	V33B
VCCINT_10	VCCINT_10
VMGTAVCC_10	VMGTAVCC_10
VMGTAVTT_12	VMGTAVTT_12
VMGTAVCCAUX_18	VMGTAVCCAUX_18
VCCAUX_18	VCCAUX_18
VCCAUXC_18	VCCAUXC_18
VCCOAC	VCCOAC
VCCOAB	VCCOAB
GND	GND

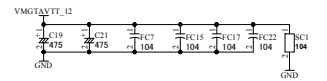
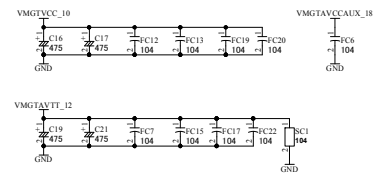
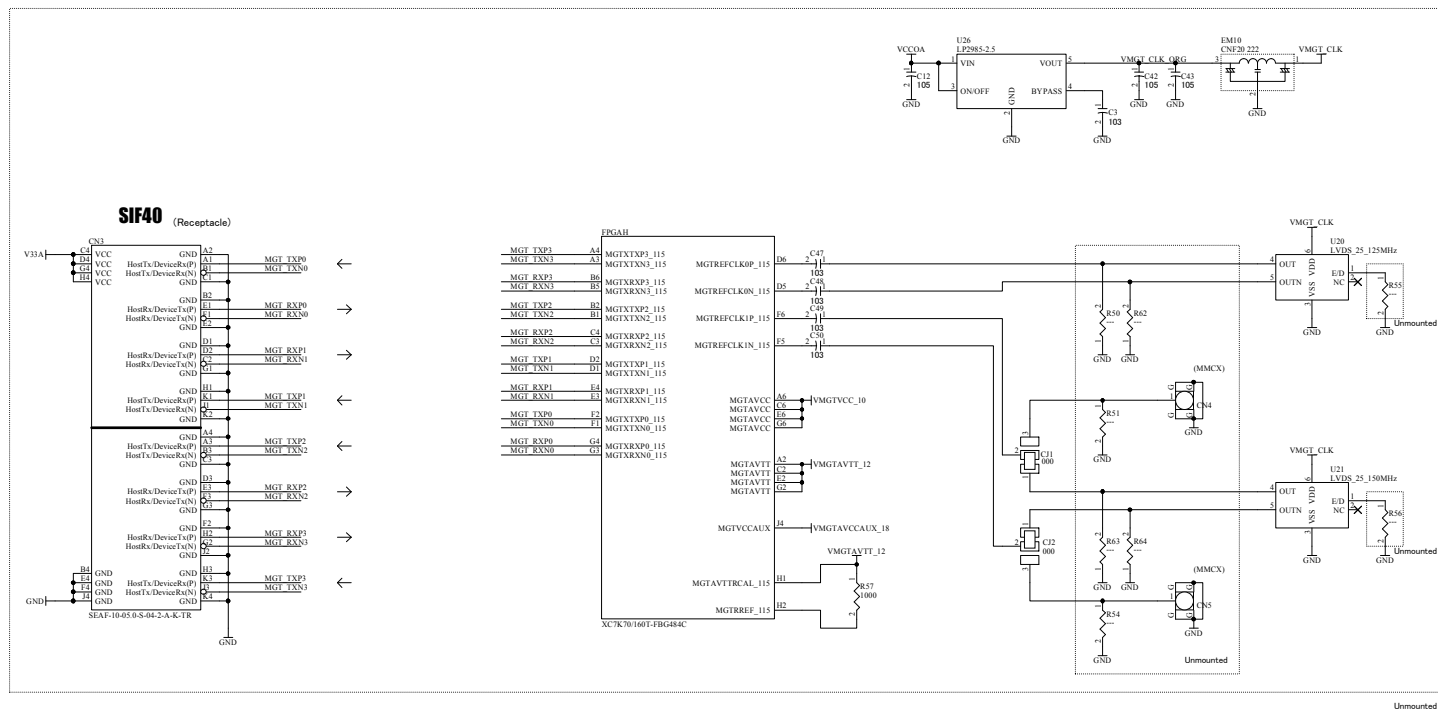

DSN	TITLE	KINTEX FBG484 FPGA Board	
DOC No.	XCM-022W		E1
FILE: XCM022_RocketIO.sch DATE: 2017/10/23 15:13:25 Sheet 4 / 4			