

V50  
V33  
V12  
GND

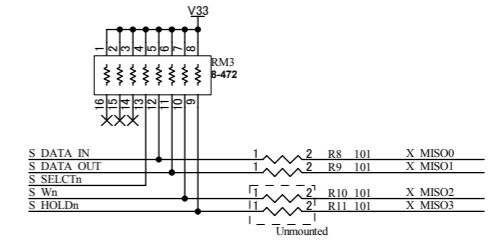

CNA, CNB		CNA, CNB	
CNA, CNB		CNA, CNB	
DIRA[0..5]	DIRB[0..5]	DIRA[0..5]	DIRB[0..5]
IOA[0..49]	IOB[0..49]	IOA[0..49]	IOB[0..49]
EXCLK[0..1]	EXCLK[0..1]	EXCLK[0..1]	EXCLK[0..1]
OEAB[0..5]	OEAB[0..5]	OEAB[0..5]	OEAB[0..5]
OEAB	OEAB	OEAB	OEAB
DIRAB	DIRAB	DIRAB	DIRAB
ASW0	ASW0	ASW0	ASW0

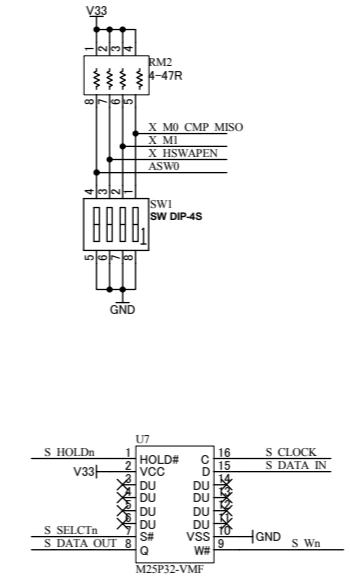
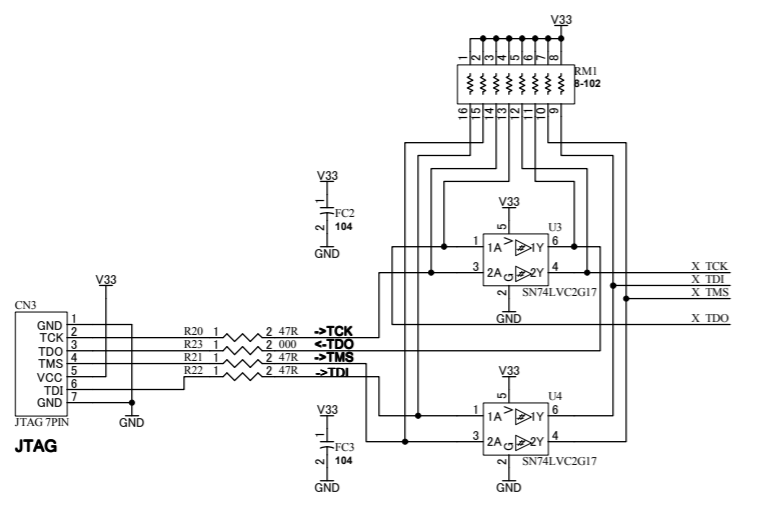
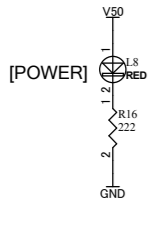
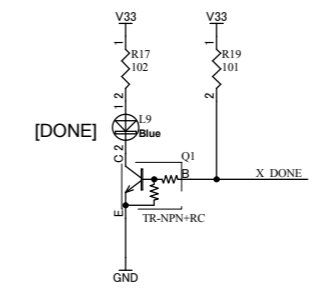
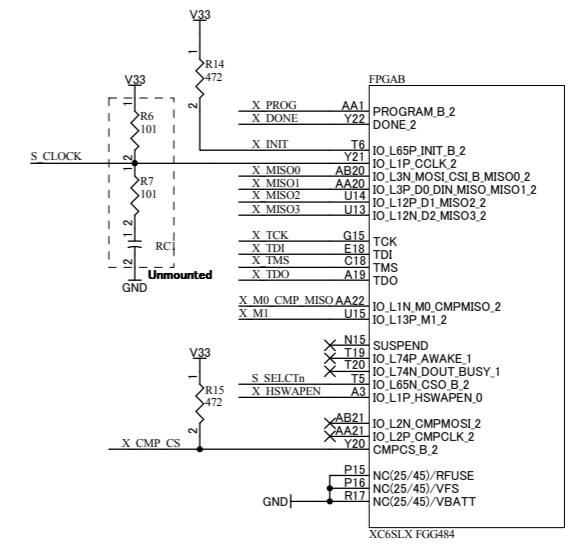
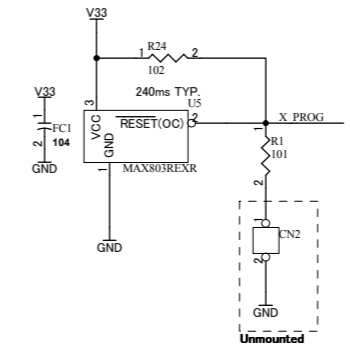
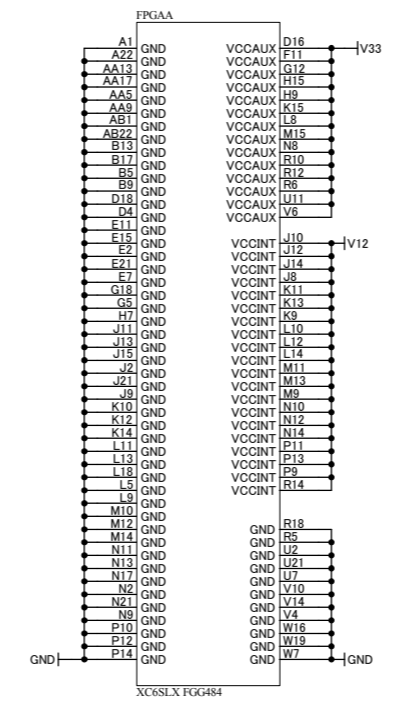
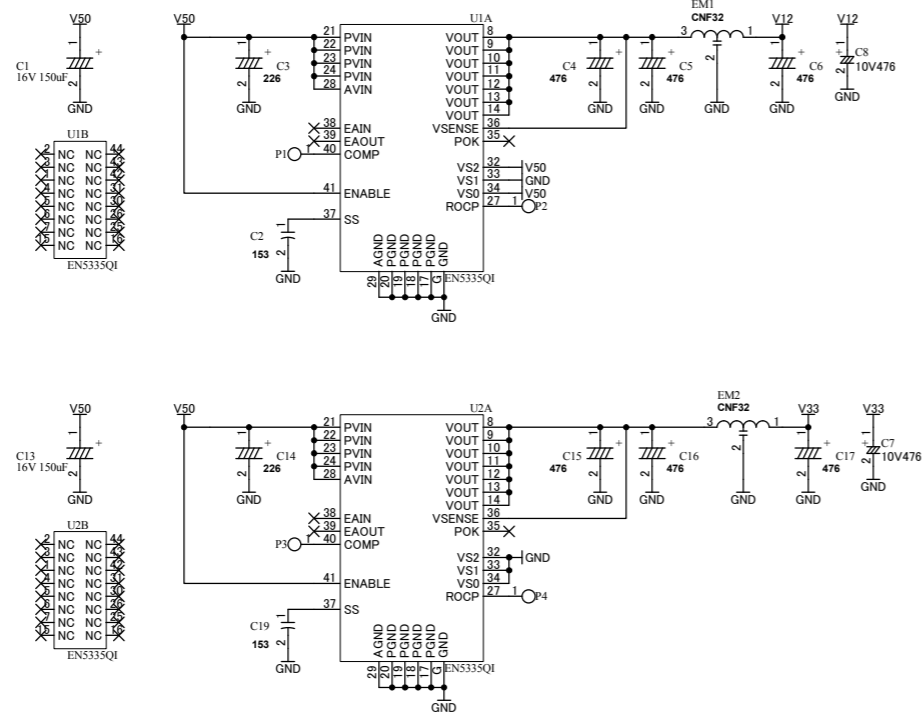
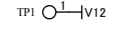
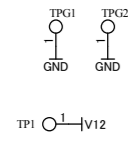
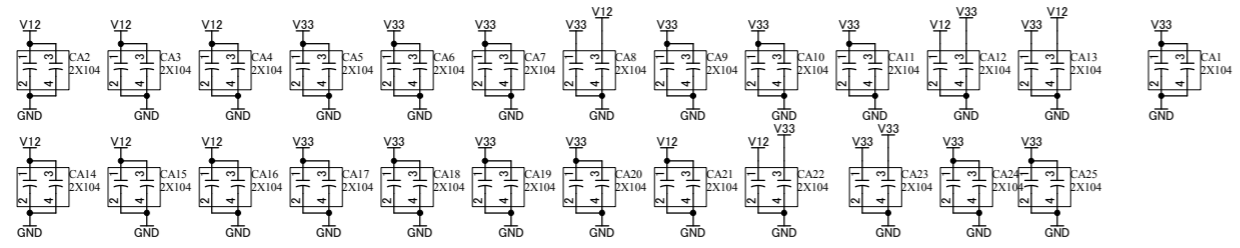

**HUMAN DATA**  
 HuMANDATA LTD.  
 OSAKA JAPAN  
 www.hdl.co.jp/en/(Global)  
 www.hdl.co.jp/(Japan)

XCM019R2-SCH-B.pdf  
 SPARTAN-6 FG484 FPGA Board (5V I/F)  
 DOC. No. XCM-019  
 Date: 24-Aug-2012 14:50:02  
 File: XCM019B.sch  
 Sheet 1 of 3

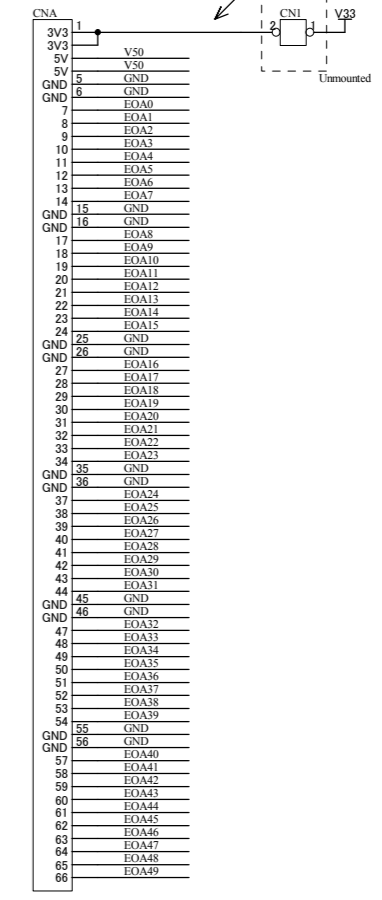
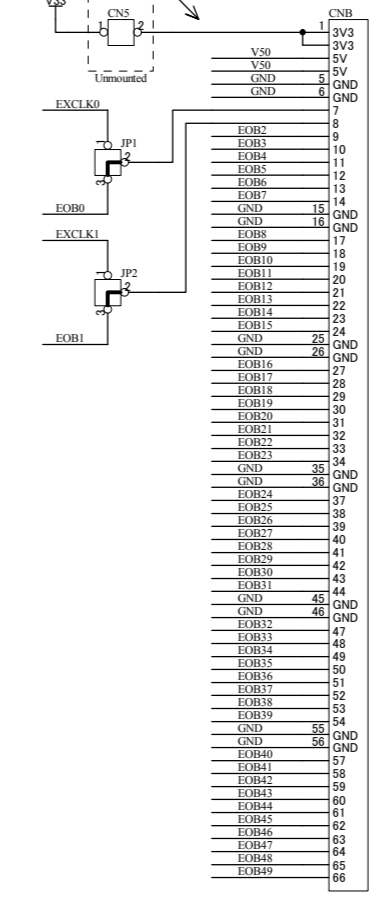
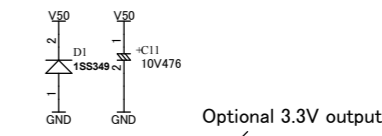
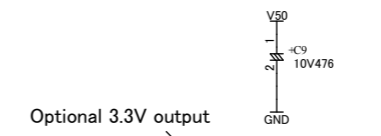
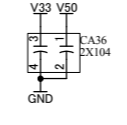
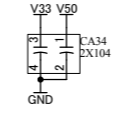
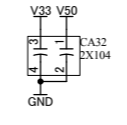
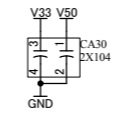
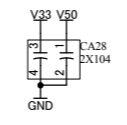
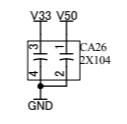
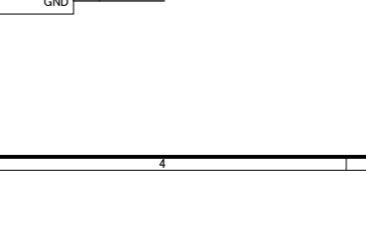
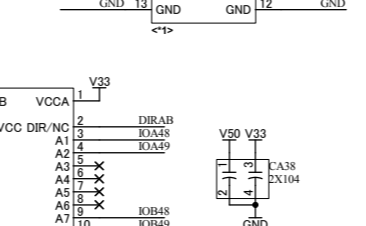
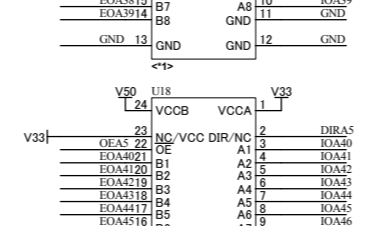
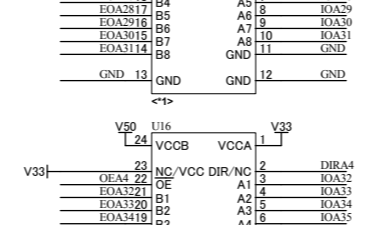
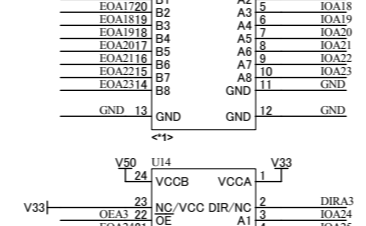
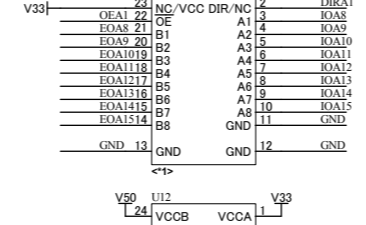
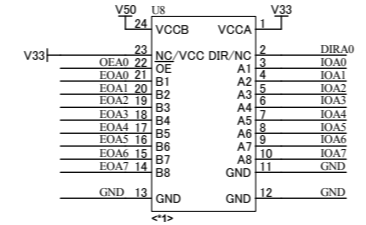
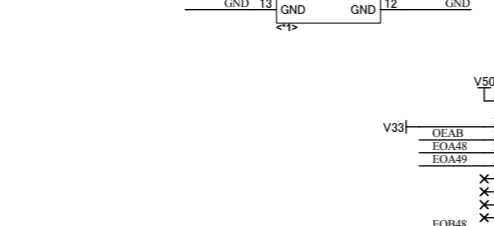
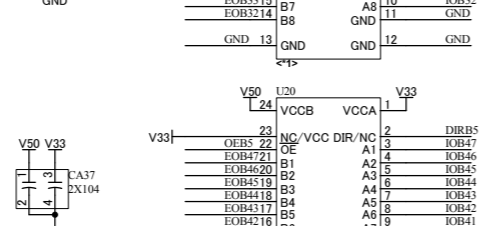
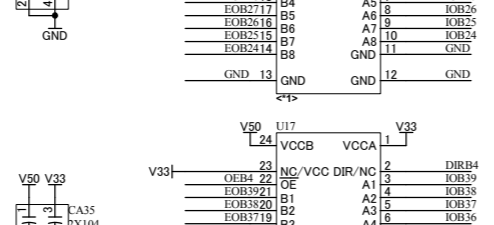
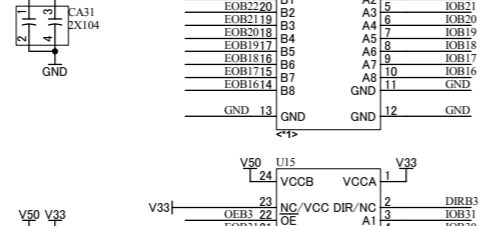
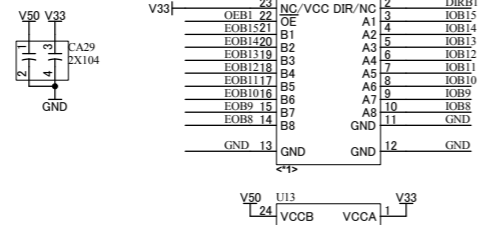
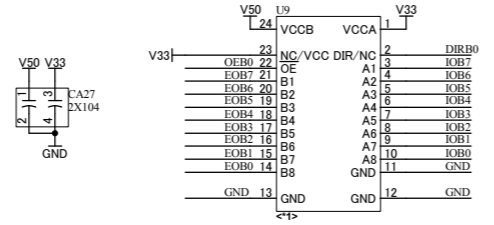
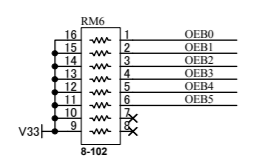
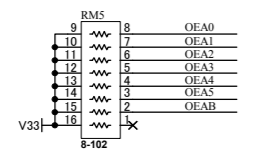
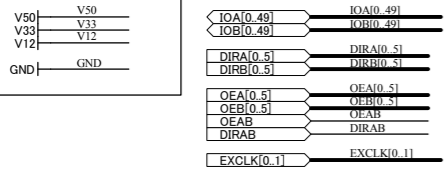

U8-20	XCM-019	XCM-019Y
	74LVCC3245	74CB3T3245

XCM019R2-SCH-B.pdf



HuMANDATA LTD.  
OSAKA JAPAN  
www.hdl.co.jp/en/(Global)  
www.hdl.co.jp/(Japan)

SPARTAN-6 FG484 FPGA Board (5V I/F)

DOC. No. XCM-019

B

Date: 24-Aug-2012 14:50:03

File: CNA\_CNB.sch

Sheet 2 of 3

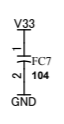
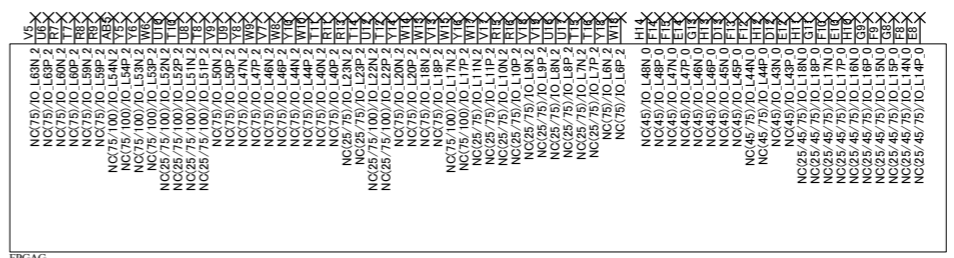
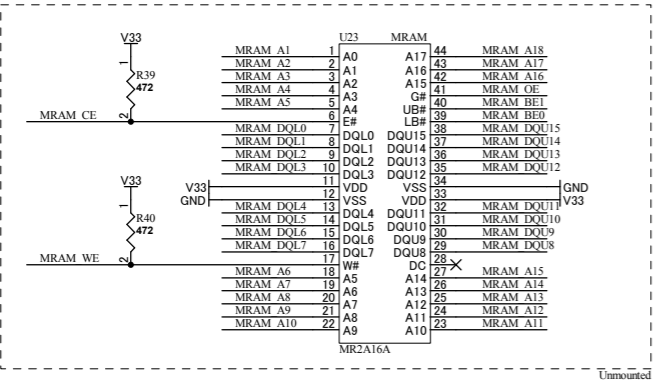
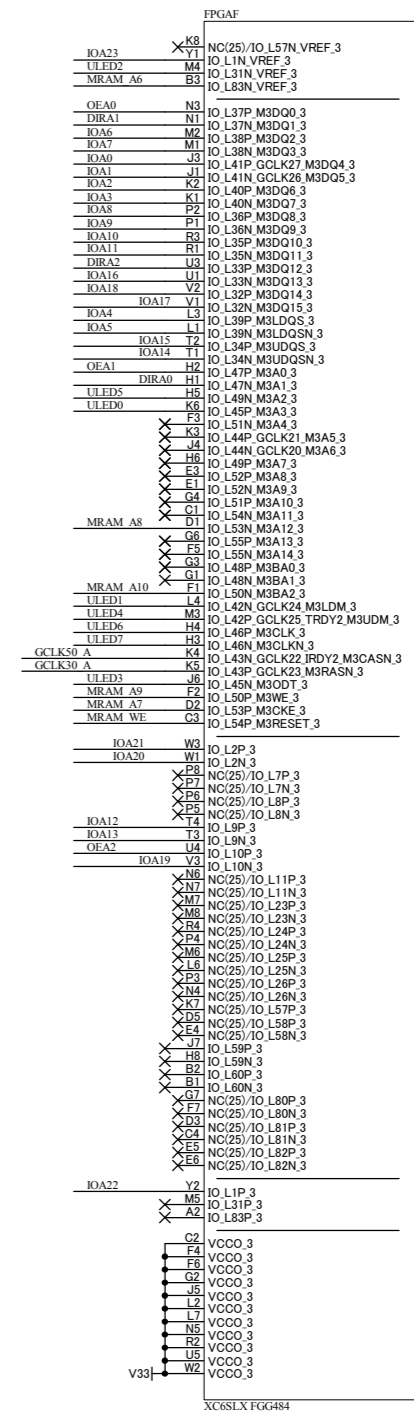
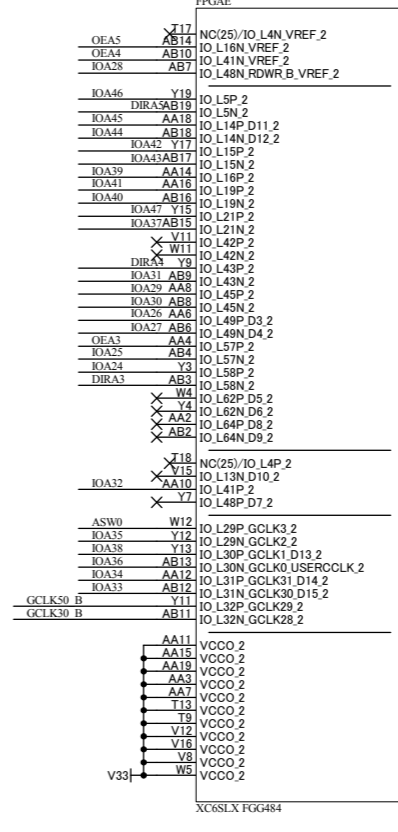
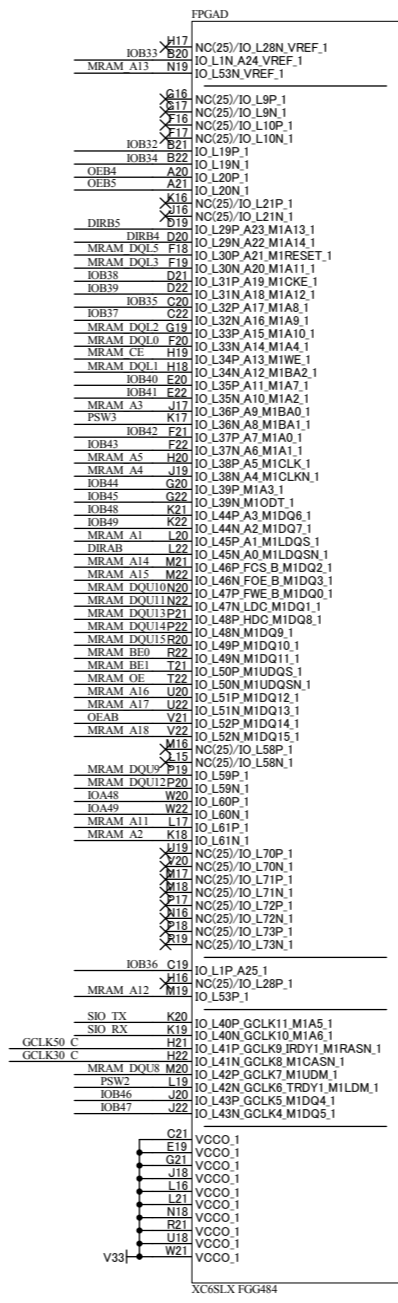
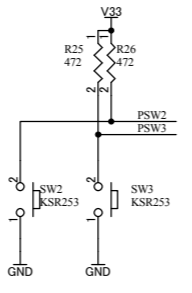
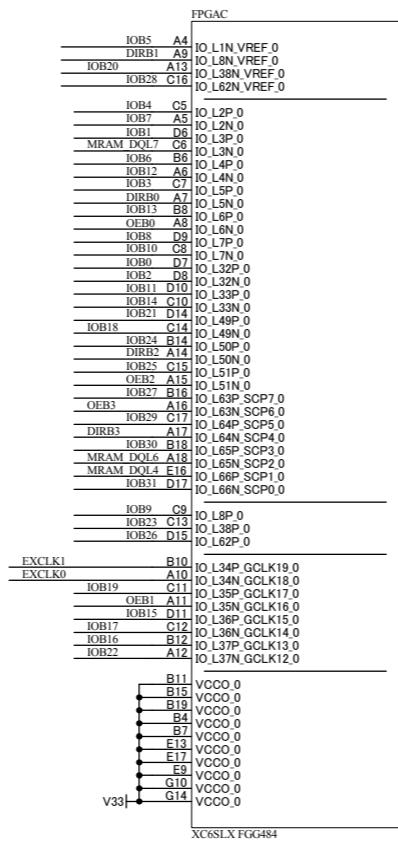
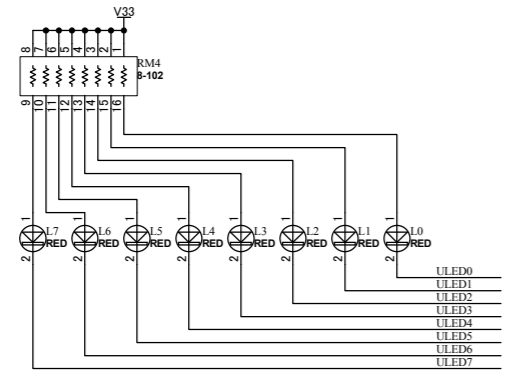
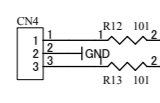
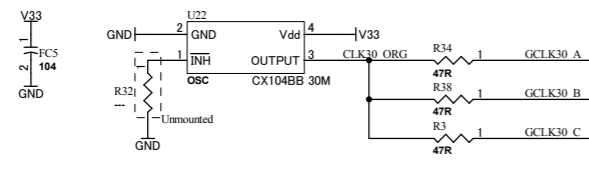
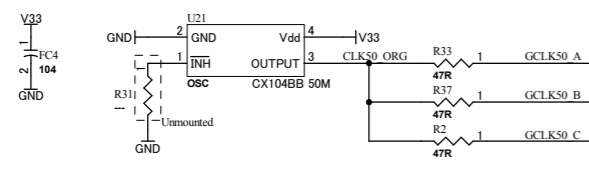
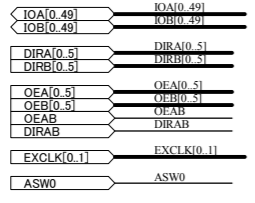
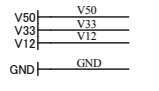

HuMANDATA LTD.  
OSAKA JAPAN  
www.hdl.co.jp/en/(Global)  
www.hdl.co.jp/(Japan)

SPARTAN-6 FG484 FPGA Board (5V I/F)

DOC. No. XCM-019

Date: 24-Aug-2012 14:50:03

File: IO.sch

Sheet 3 of 3

XCM019R2-SCH-B.pdf