

V12
V33A
V33B
V33S
V33S
VRF4
VRF4
VRF4
VRF4
GND

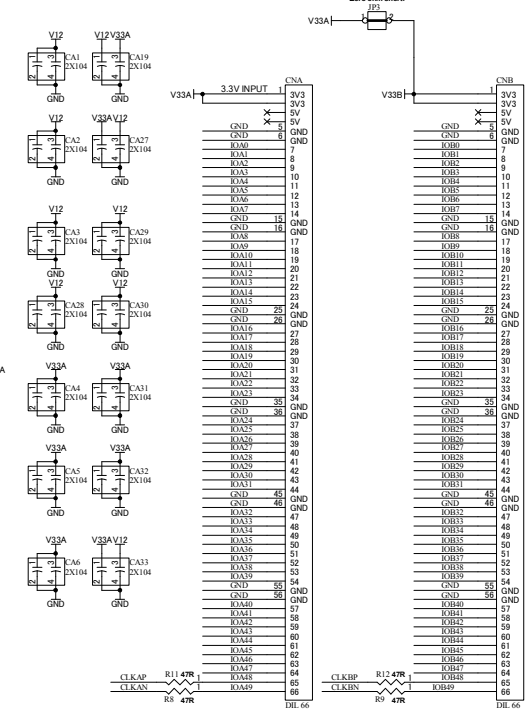

XCM016R1-SCH-A1.pdf

	2010/03/15	Xilinx Spartan-3A DSP FGG676 FPGA board	
	HuMANDATA LTD. OSAKA JAPAN www.hdl.co.jp/en/ (Global) www.hdl.co.jp/ (Japan)		
Date: 15-Mar-2010	09:04:37	File: XCM016A.sch	Sheet 1 of 2

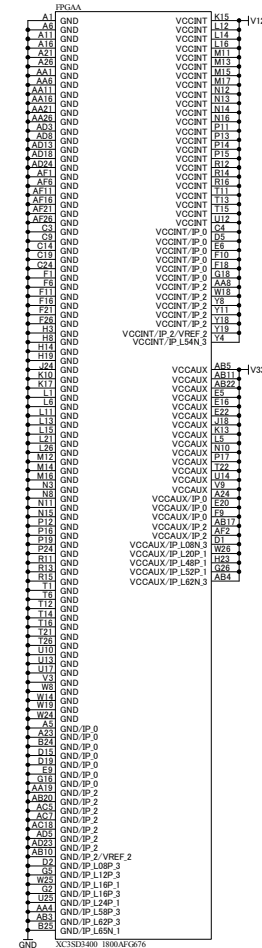
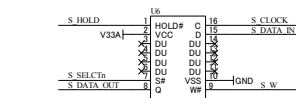
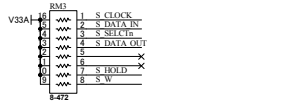
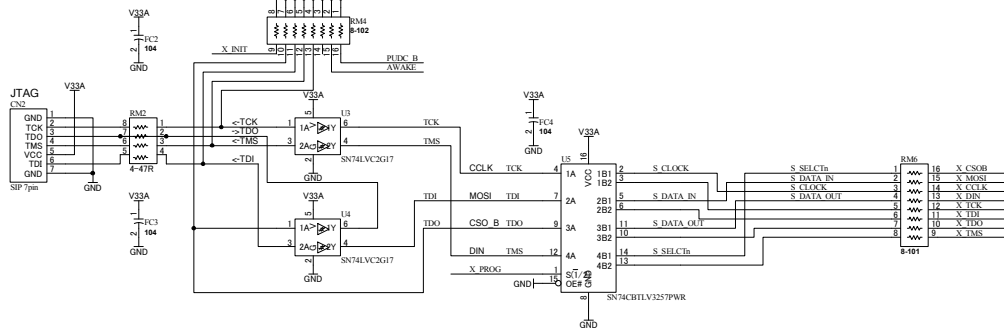
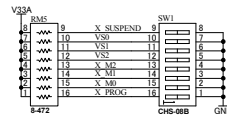
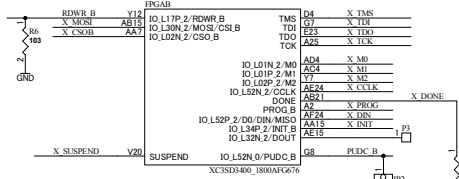
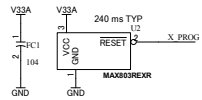
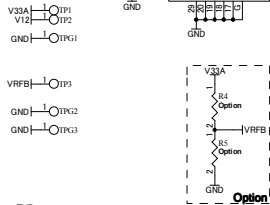
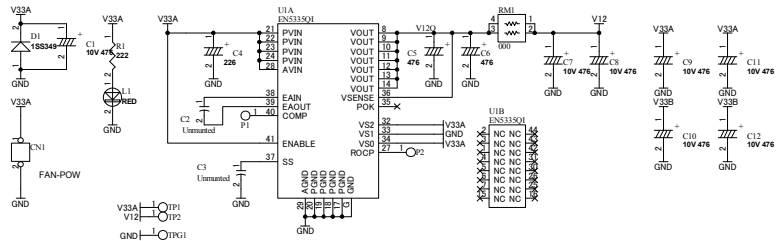