

V12 V12_A
 V33_A V33_B
 VRF0 VRF0
 GND GND

VDDR_09 VDDR_09
 VDDR_18 VDDR_18

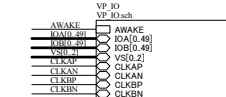
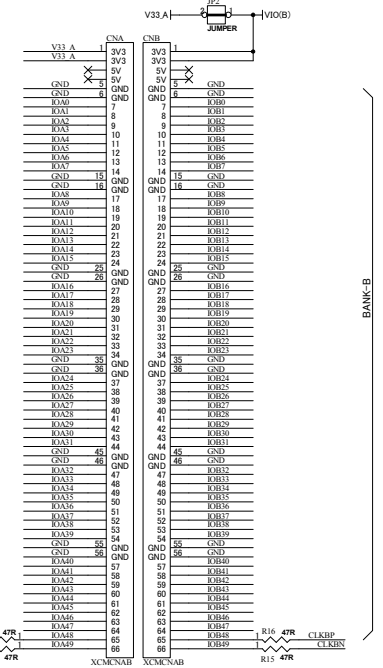
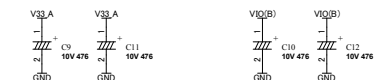
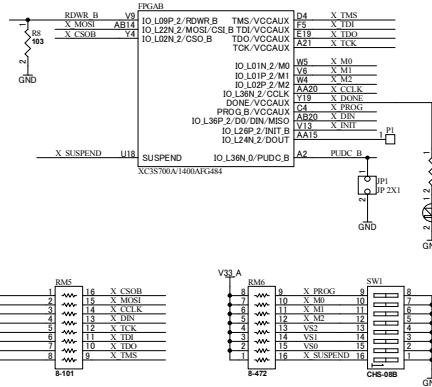
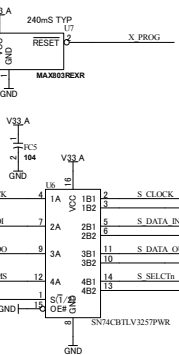
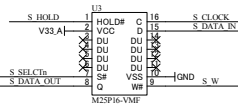
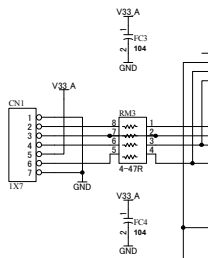
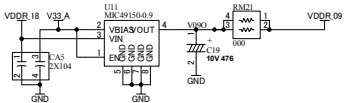
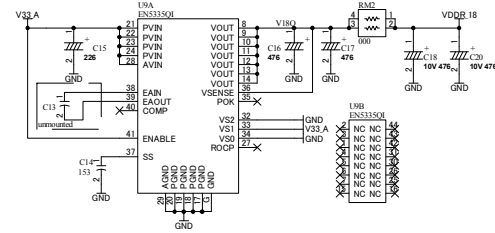
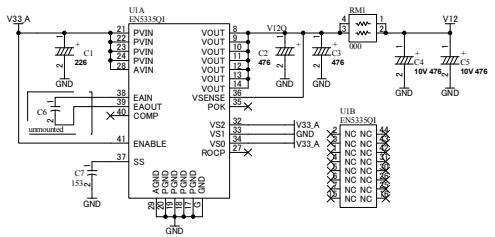
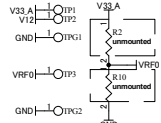
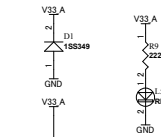

XCM015R1-SCH-B2.pdf

	2010/08/05	SPARTAN-3A FGG484 FPGA Board		DOC. No. XCM-015	B2
	HuMANDATA LTD. OSAKA JAPAN www.hdl.co.jp/en/ (Global) www.hdl.co.jp/ (Japan)				

