

V12  
V25  
V33 A  
V50  
GND

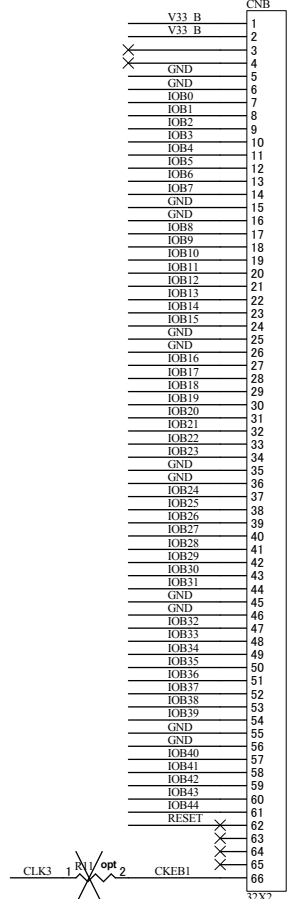
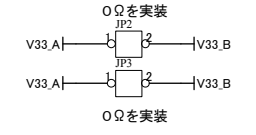
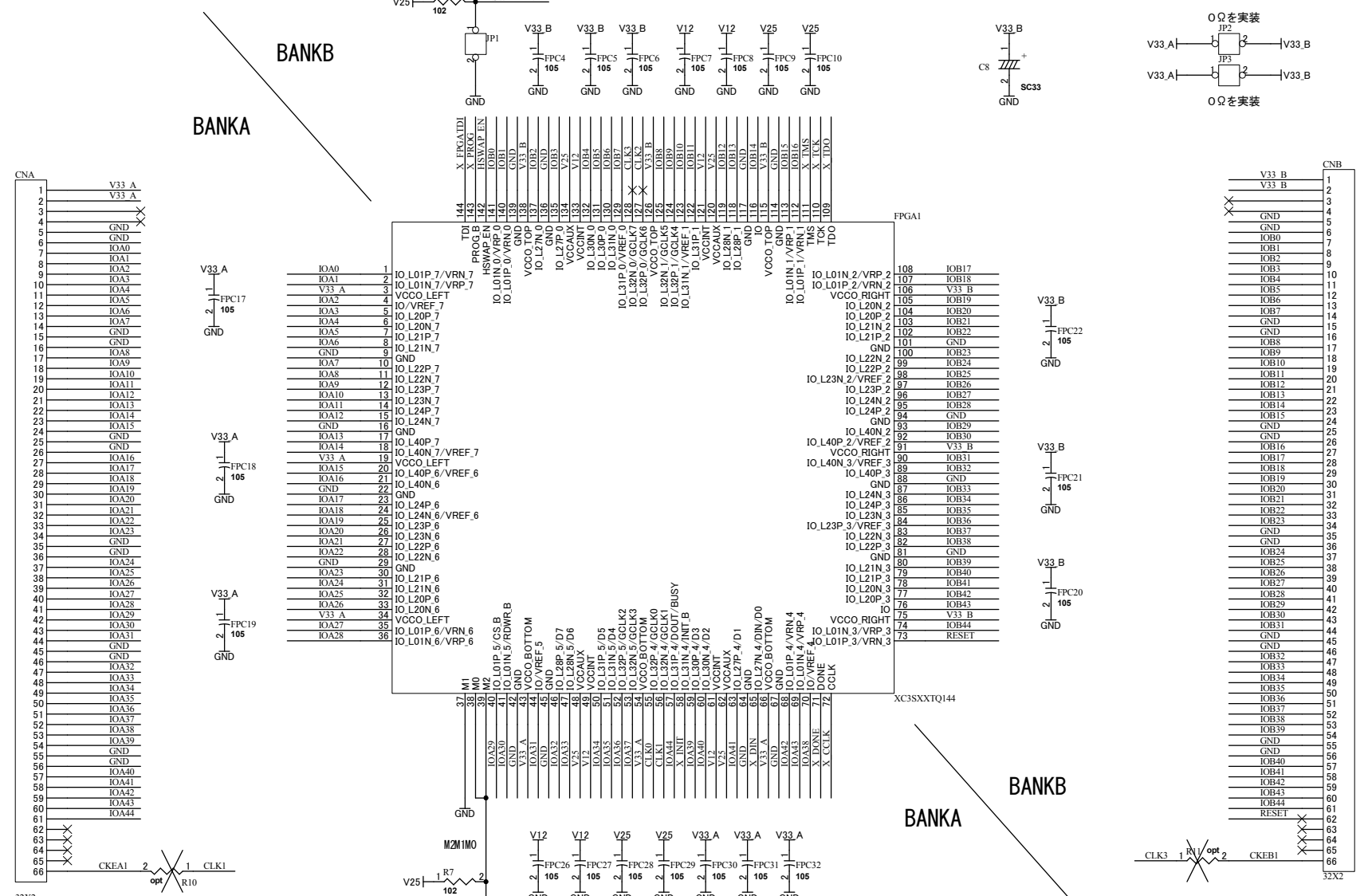
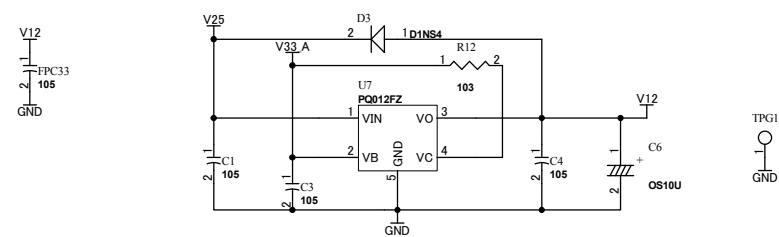
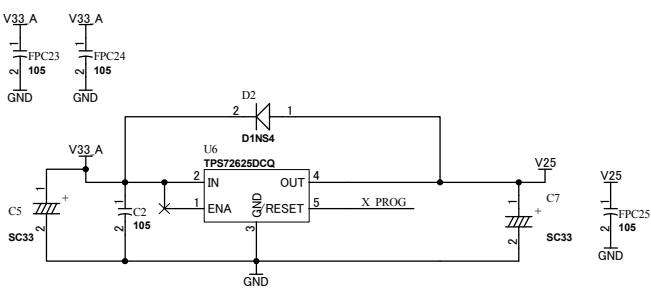
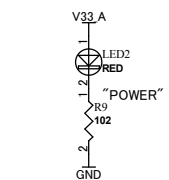
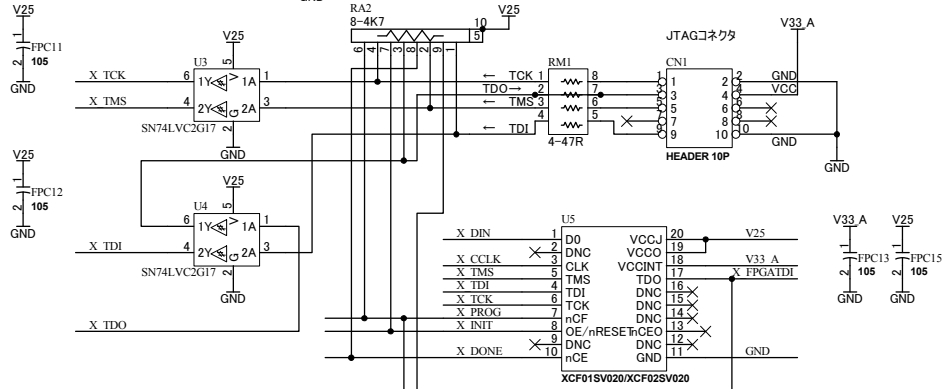
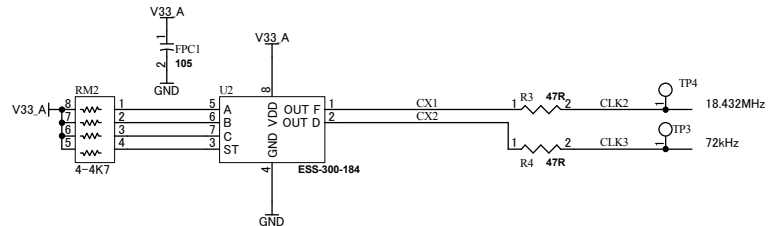
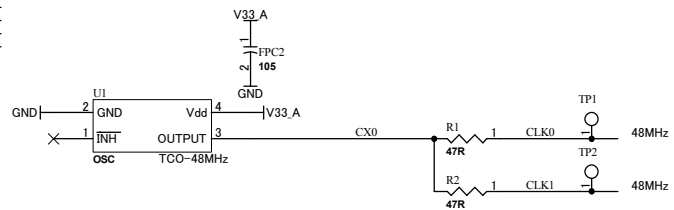

HuMANDATA LTD.  
OSAKA JAPAN  
www.hdl.co.jp

SP3 TQ144 FPGA BOARD

DOC. No. XCM-008

B

Date: 6-Jul-2005 14:41:53
File: XCM008B.sch
Sheet 1 of 1