

V25	V25
V33	V33
V50	V50
GND	GND

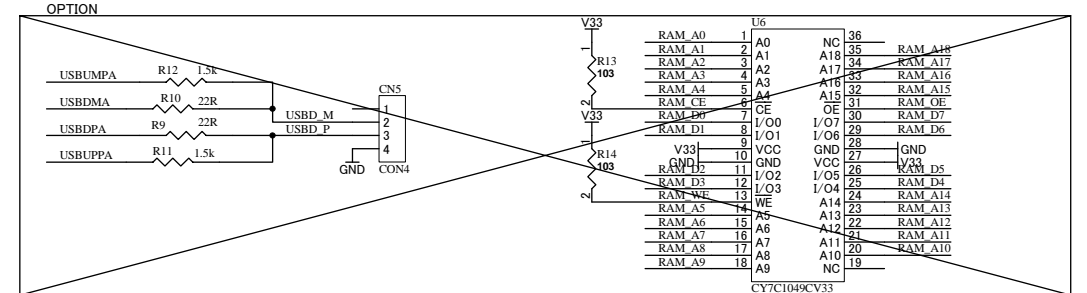
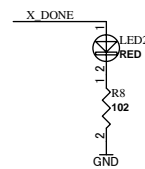
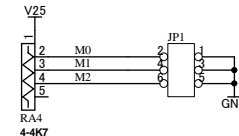
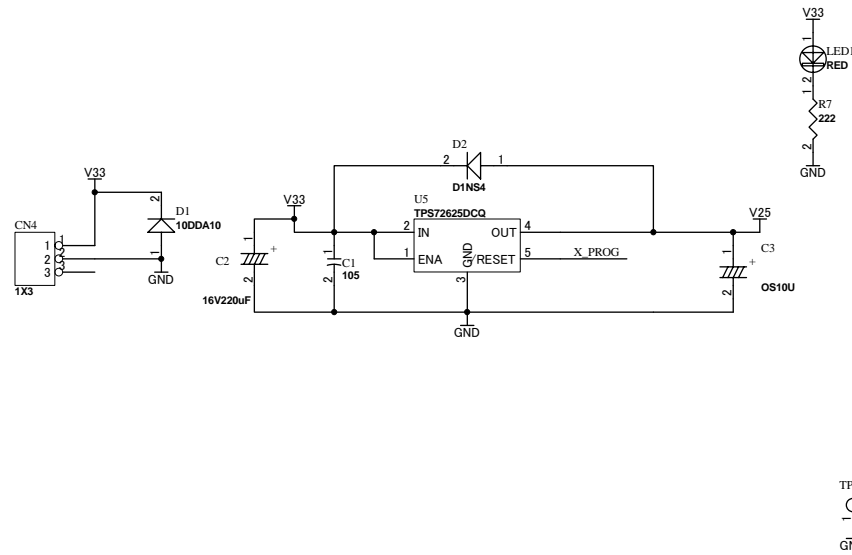
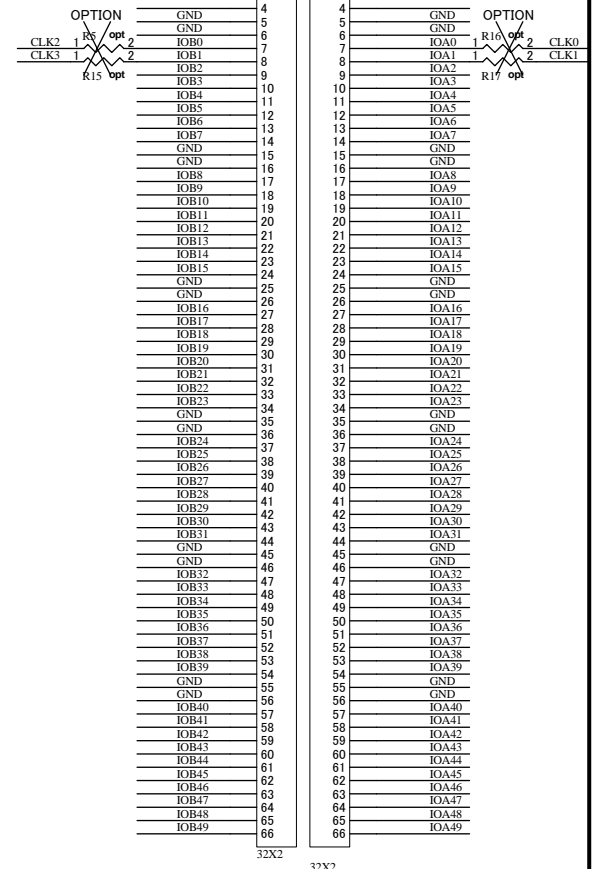
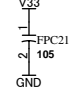
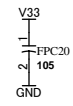
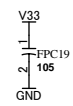
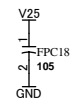
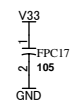
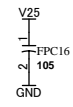
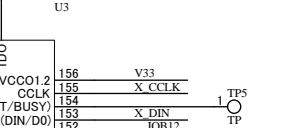
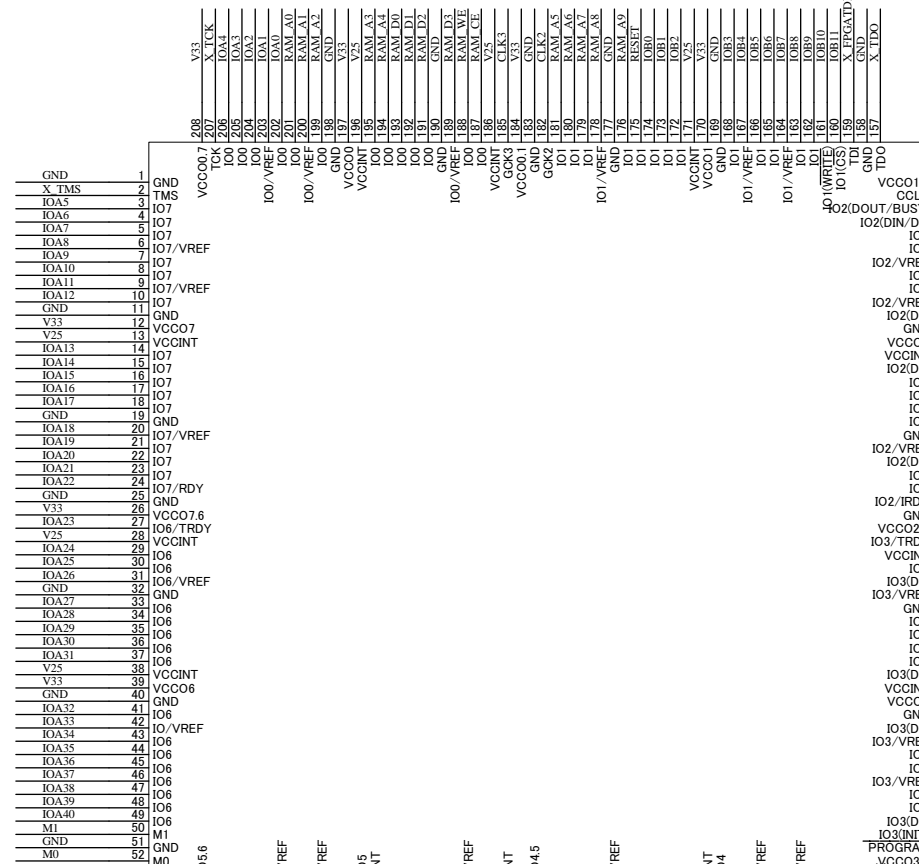
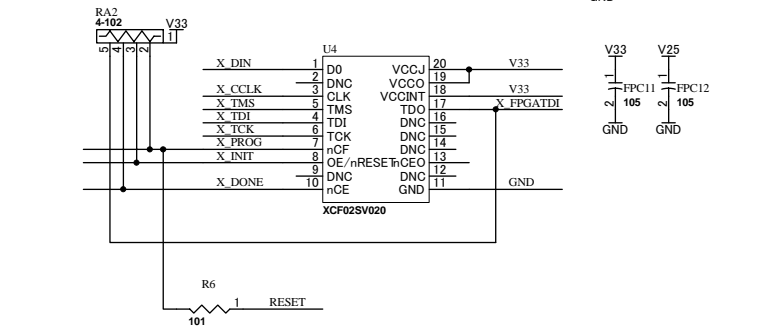
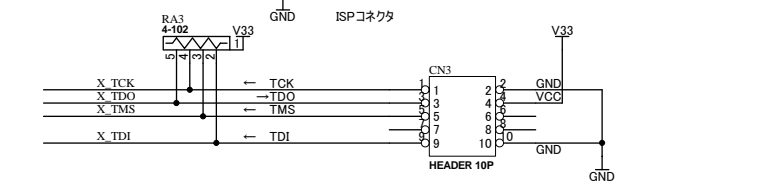
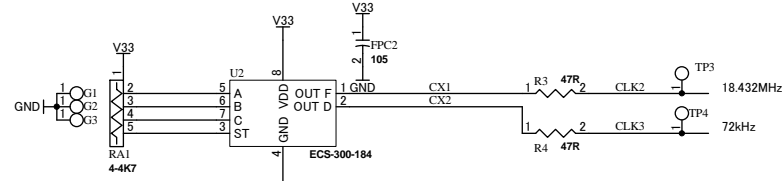
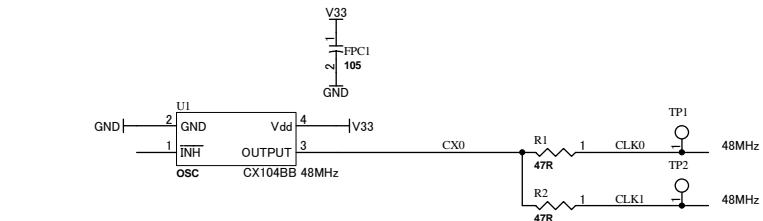
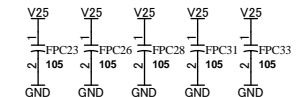
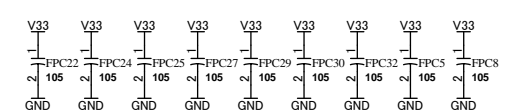
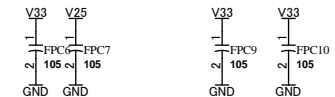
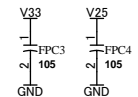

		2008/04/15	
HuMANDATA LTD. OSAKA JAPAN www.hdl.co.jp			
Date: 24-Dec-2009 18:23:11		File: XCM004A.sch	
		Sheet 1 of 1	
SP2 FPGA BOARD		DOC. No.	XCM-004
		A2	