

V12 V12  
 V25 V25  
 V33 A V33 A  
 V50 V50  
 GND GND

V33 A V25 V12 V33 A V25 V12 V33 A V33 A  
 FC1 FC2 FC3 FC4 FC5 FC6 FC7 FC8 FC9 FC10

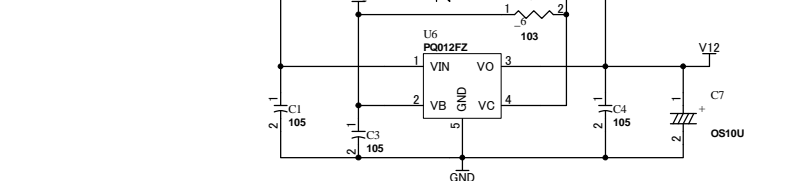
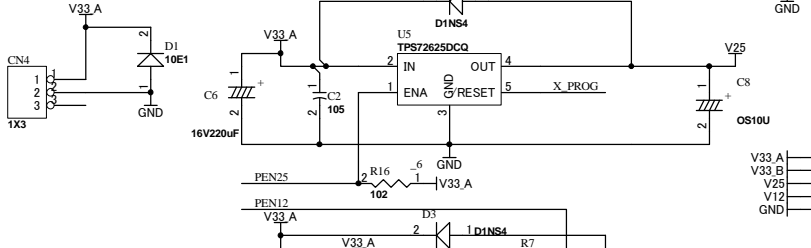
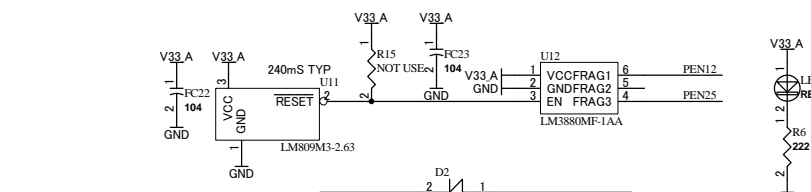
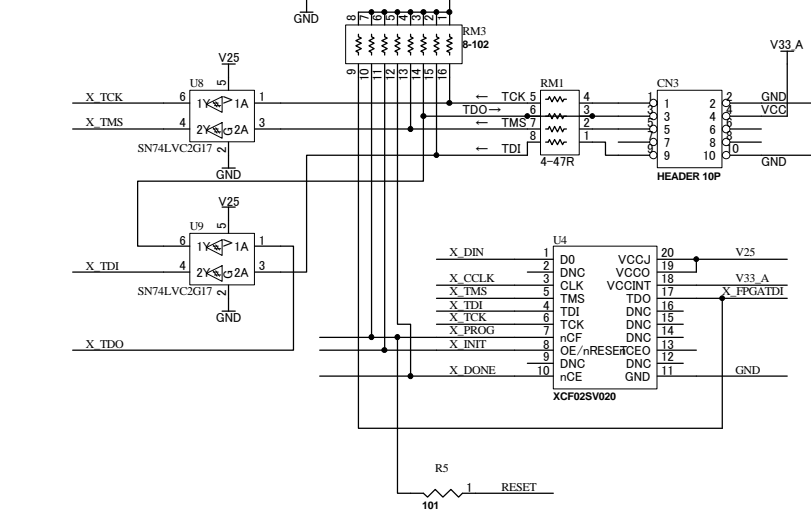
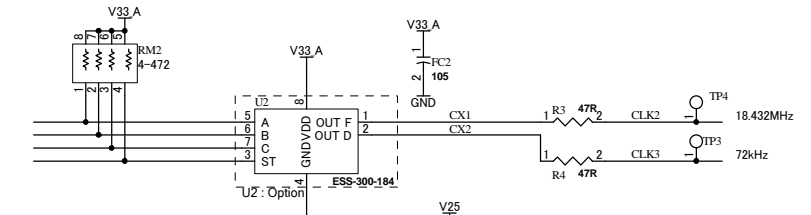
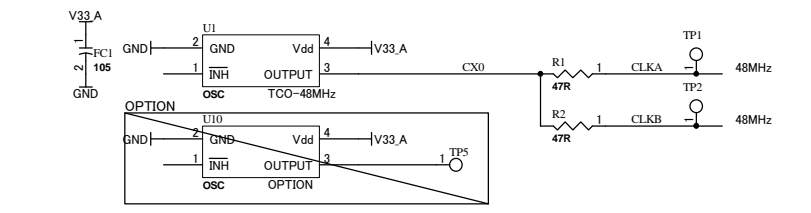

1	V33 A
2	V33 A
3	GND
4	GND
5	GND
6	GND
7	GND
8	GND
9	GND
10	GND
11	GND
12	GND
13	GND
14	GND
15	GND
16	GND
17	GND
18	GND
19	GND
20	GND
21	GND
22	GND
23	GND
24	GND
25	GND
26	GND
27	GND
28	GND
29	GND
30	GND
31	GND
32	GND
33	GND
34	GND
35	GND
36	GND
37	GND
38	GND
39	GND
40	GND
41	GND
42	GND
43	GND
44	GND
45	GND
46	GND
47	GND
48	GND
49	GND
50	GND
51	GND
52	GND
53	GND
54	GND
55	GND
56	GND
57	GND
58	GND
59	GND
60	GND
61	GND
62	GND
63	GND
64	GND
65	GND
66	GND

1	GND	156	IOB7
2	IOA5	157	IOB8
3	IOA6	158	IOB9
4	IOA7	159	IOB10
5	IOA8	160	IOB11
6	IOA9	161	IOB12
7	IOA10	162	IOB13
8	IOA11	163	IOB14
9	IOA12	164	IOB15
10	IOA13	165	IOB16
11	IOA14	166	IOB17
12	IOA15	167	IOB18
13	IOA16	168	IOB19
14	IOA17	169	IOB20
15	IOA18	170	IOB21
16	IOA19	171	IOB22
17	IOA20	172	IOB23
18	IOA21	173	IOB24
19	IOA22	174	IOB25
20	IOA23	175	IOB26
21	IOA24	176	IOB27
22	IOA25	177	IOB28
23	IOA26	178	IOB29
24	IOA27	179	IOB30
25	IOA28	180	IOB31
26	IOA29	181	IOB32
27	IOA30	182	IOB33
28	IOA31	183	IOB34
29	IOA32	184	IOB35
30	IOA33	185	IOB36
31	IOA34	186	IOB37
32	IOA35	187	IOB38
33	IOA36	188	IOB39
34	IOA37	189	IOB40
35	IOA38	190	IOB41
36	IOA39	191	IOB42
37	IOA40	192	IOB43
38	IOA41	193	IOB44
39	IOA42	194	IOB45
40	IOA43	195	IOB46
41	IOA44	196	IOB47
42	IOA45	197	IOB48
43	IOA46	198	IOB49
44	IOA47	199	GND
45	IOA48	200	GND
46	IOA49	201	GND

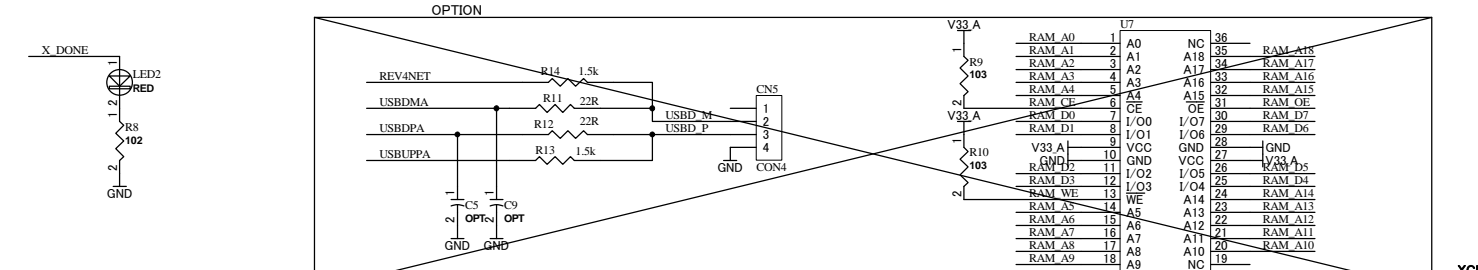
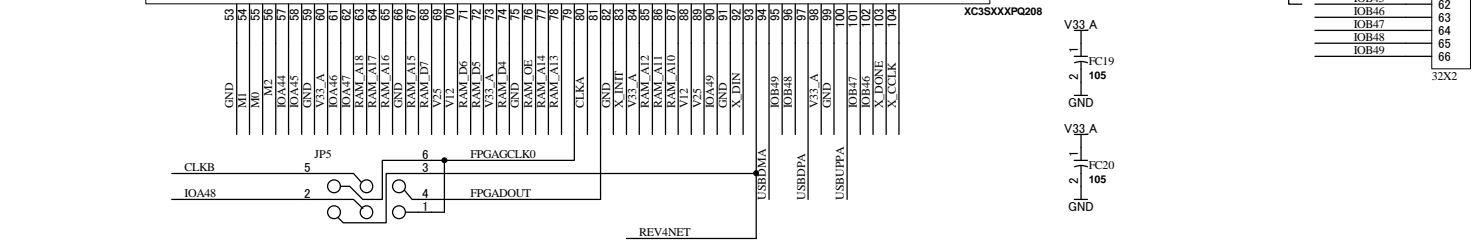

HuMANDATA LTD.  
 OSAKA JAPAN  
 www.hdl.co.jp/en/(Global)  
 www.hdl.co.jp/(Japan)

SP3 FPGA BOARD(Rev.4)

DOC. No. XCM-001

H2

Date: 2-Jul-2013 14:28:56

File: XCM001H1.sch

Sheet 1 of 1