

V50  
V33  
V33CN  
V50CN  
VUSB

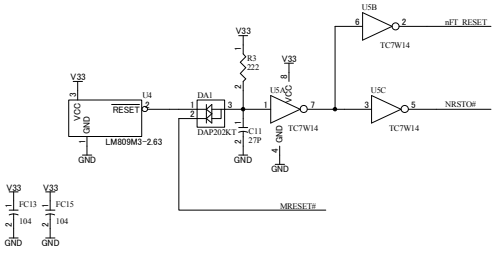

USB105MR1-SCH-B4.pdf

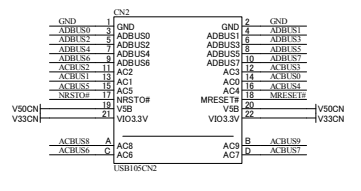
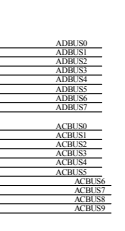
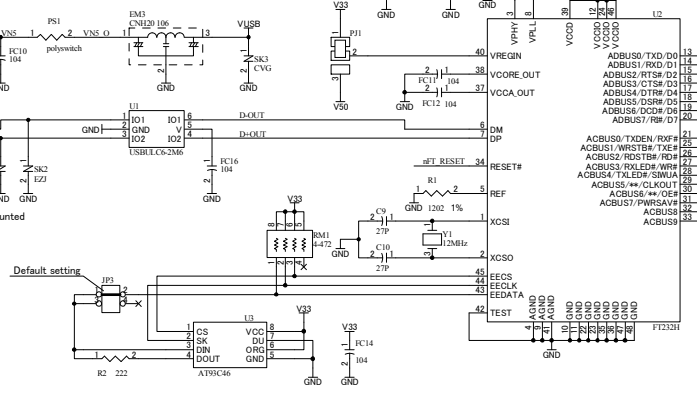
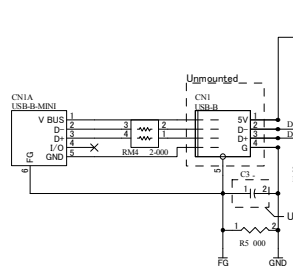
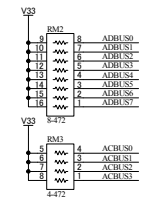
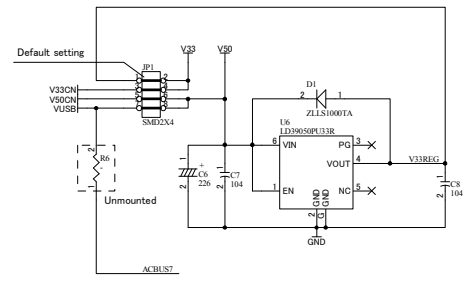
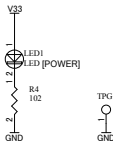

DSN	TITLE	FTDI FT232H Evaluation Board	
DOC No:	<b>USB-105-M</b>	<b>B4</b>	
FILE	USB105B-M.sch	DATE	18-Oct-2016 17:23:58