

Top Overlay
Top Solder Mask

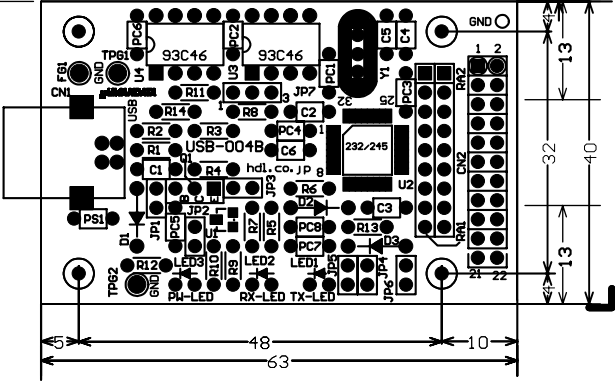

HumANDATA LTD.	HUMANDATA	出力ファイル名 OUTPUT FILE NEME
TITLE: USB004B		USB004B .GTS
PART NO.: USB-004B		
FILE NAME: USB004B.pcb	DATE: 12-Mar-2003	2003/3/13

有限会社ヒューマンデータ

TopLayer

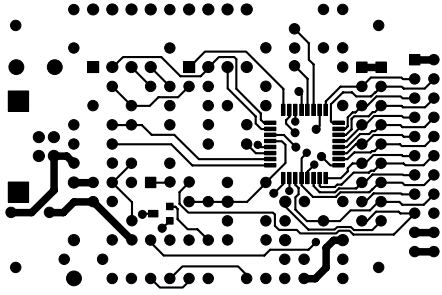

HumANDATA LTD.	HUMANDATA	出力ファイル名 OUTPUT FILE NEME
TITLE: USB004B		USB004B
PART NO.: USB-004B		
FILE NAME: USB004B.pcb	DATE: 12-Mar-2003	2003/3/13

有限会社ヒューマンデータ

BottomLayer

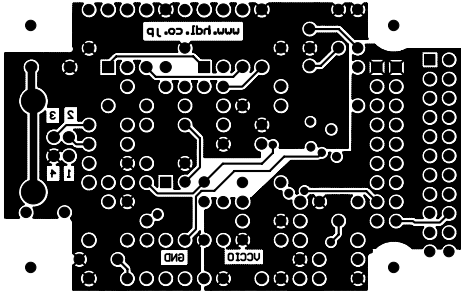

HuMANDATA LTD.	HuMANDATA	出力ファイル名 OUTPUT FILE NAME
TITLE: USB004B		USB004B
PART NO.: USB-004B		
FILE NAME: USB004B.pcb	DATE: 12-Mar-2003	2003/3/13

有限会社ヒューマンデータ

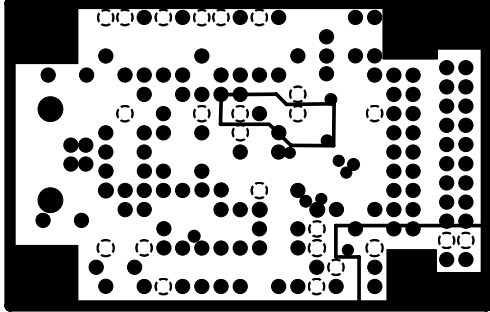

HuMANDATA LTD.	HuMANDATA	出力ファイル名 OUTPUT FILE NAME
TITLE: USB004B		USB004B
PART NO.: USB-004B		
FILE NAME: USB004B.pcb	DATE: 12-Mar-2003	2003/3/13

有限会社ヒューマンデータ

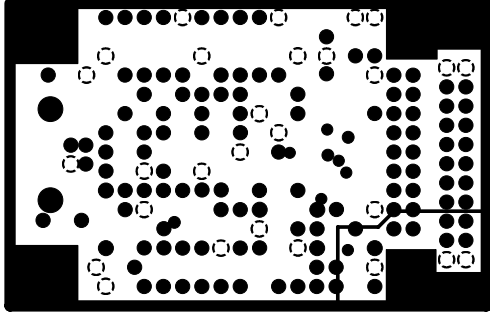

HuMANDATA LTD.	HuMANDATA	出力ファイル名 OUTPUT FILE NAME
TITLE: USB004B		USB004B
PART NO.: USB-004B		
FILE NAME: USB004B.pcb	DATE: 12-Mar-2003	2003/3/13

有限会社ヒューマンデータ

Top Overlay

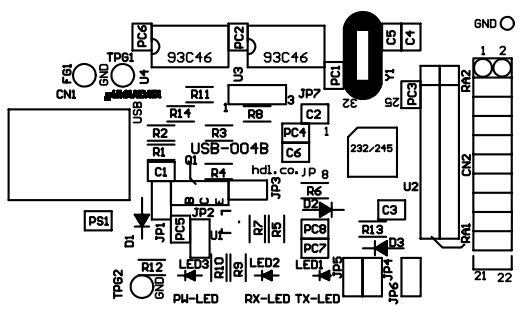

HumANDATA LTD.	HUMANDATA	出力ファイル名 OUTPUT FILE NEME
TITLE: USB004B		USB004B
PART NO.: USB-004B		
FILE NAME: USB004B.pcb	DATE: 12-Mar-2003	2003/3/13

有限会社ヒューマンデータ

```

      A A A A A A A A A A A A A A A A A A
D     A A A A A A A A A A A A A A A A A A
      A A A A A A A A A A A A A A A A A A
      B A A A A A A A A A A A A A A A A A
        A A A A A A A A A A A A A A A A A A
        A A A A A A A A A A A A A A A A A A
        A A A A A A A A A A A A A A A A A A
      B C A A A A A A A A A A A A A A A A A
      A A A A A A A A A A A A A A A A A A
        C A A A A A A A A A A A A A A A A A
      D A A A A A A A A A A A A A A A A A
        A A A A A A A A A A A A A A A A A
  
```

E	6	19.685mil	0.5mm	PTH
F	8	23.622mil	0.6mm	PTH
A	148	35.433mil	0.9mm	PTH
C	6	39.37mil	1mm	PTH
B	2	90.551mil	2.3mm	PTH
D	4	137.795mil	3.5mm	NPTH
	174	Total		



HuMANDATA LTD.	HuMANDATA	出力ファイル名 OUTPUT FILE NEME
TITLE: USB004B		USB004B
PART NO.: USB-004B		
FILE NAME: USB004B.pcb	DATE: 12-Mar-2003	2003/3/13

有限会社ヒューマンデータ

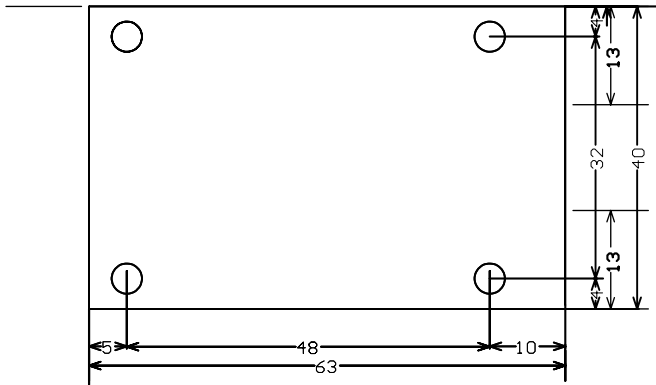

HUMANDATA LTD.	HUMANDATA	出力ファイル名 OUTPUT FILE NAME
TITLE: USB004B		USB004B
PART NO.: USB-004B		
FILE NAME: USB004B.pcb	DATE: 12-Mar-2003	2003/3/13

有限会社ヒューマンデータ