

VIO(D) VIO(D)
 VIO(C) VIO(C)
 VIO(B) VIO(B)
 V33A V33A
 GND GND

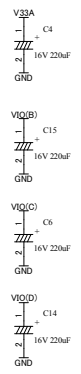
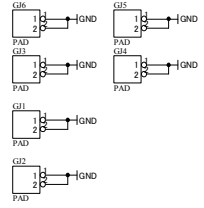
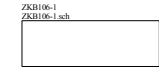
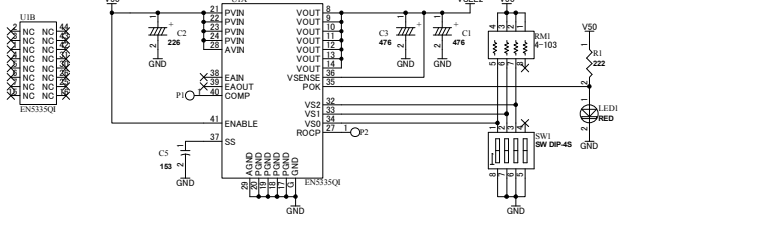
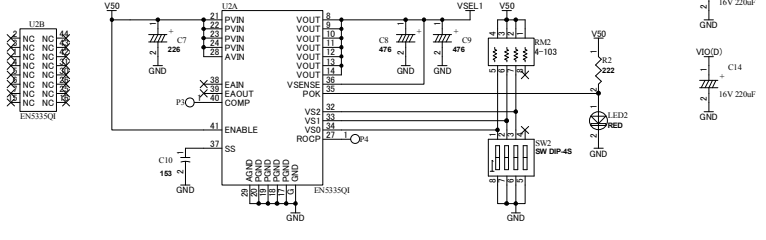
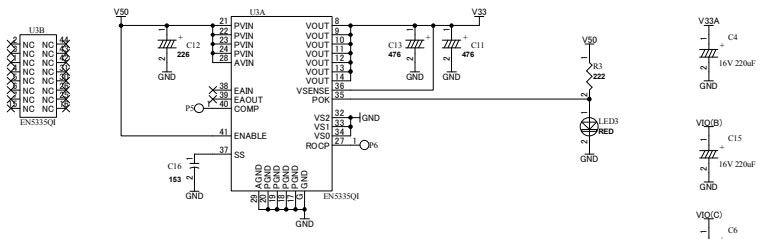
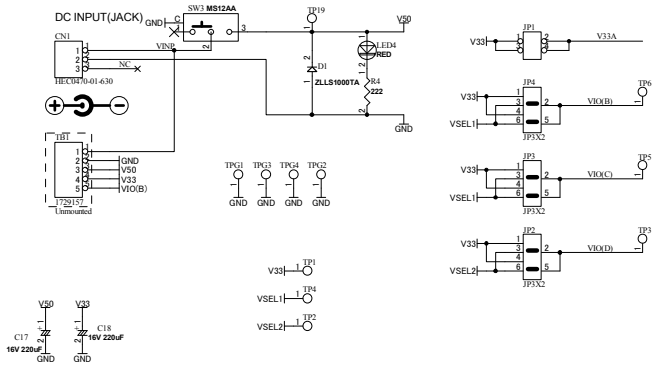

GI PARTS

HUMAN DATA
 HUMAN DATA LTD.
 www.hdi.co.jp

ZKB106R1-SCH-A5.pdf	
DSN	TITLE
	Universal board for ACM/XCM-2 series Type2
DOC No:	ZKB-106
	A5
FILE: ZKB106A.sch	DATE: 22-Feb-2017 11:49:30
Sheet: 1	2

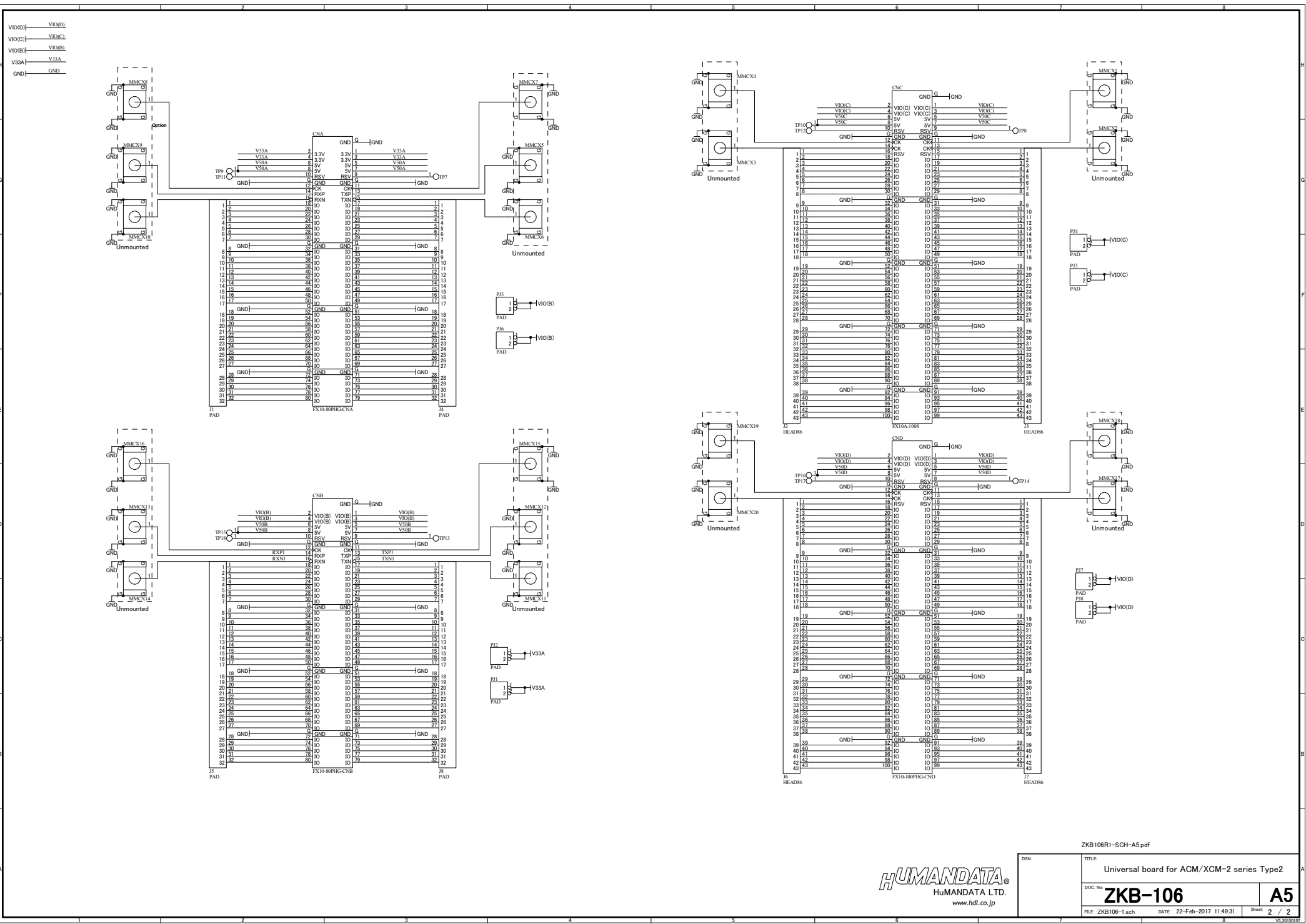

ZKB106R1-SCH-A5.pdf



DSN	TITLE	Universal board for ACM/XCM-2 series Type2	
DOC No:	ZKB-106	A5	
FILE: ZKB106-1.sch	DATE: 22-Feb-2017 11:49:31	Sheet	2 / 2