

DC INPUT(JACK)

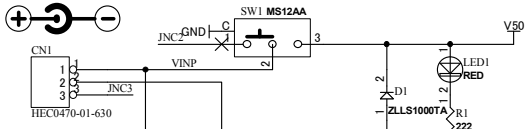

DC INPUT(Terminal)

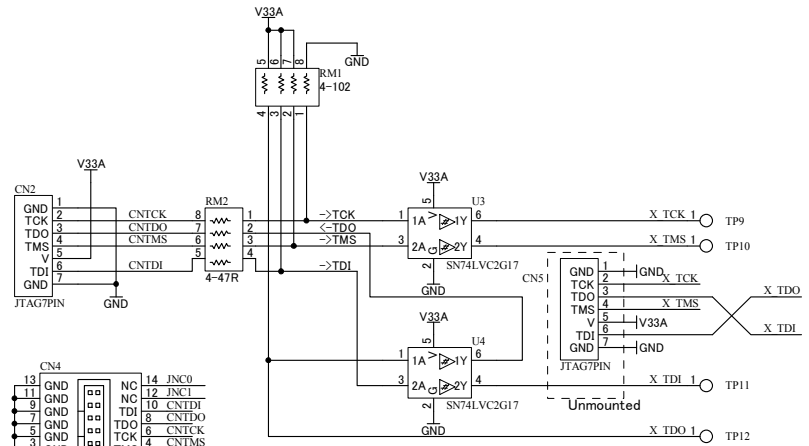
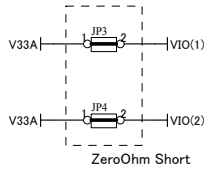
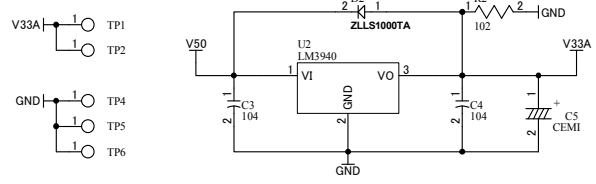
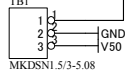

IOB0	1	NOB/GCLK IOA/GCLK	68	IOA0
IOB1	2	NOB/GCLK IOA/GCLK	67	IOA1
IOB2	3	NOB/GCLK IOA/GCLK	66	IOA2
IOB3	4	IOB	65	IOA3
IOB4	5	IOB	64	IOA4
IOB5	6	IOB	63	IOA5
IOB6	7	IOB	62	IOA6
IOB7	8	IOB	61	IOA7
	9	IOB	60	IOA8
	10	IOB	59	IOA9
	11	IOB	58	IOA10
	12	IOB	57	IOA11
	13	IOB	56	IOA12
	14	IOB	55	IOA13
	15	IOB	54	IOA14
	16	IOB	53	IOA15
	17	IOB	52	IOA16
	18	IOB	51	IOA17
	19	IOB	50	IOA18
	20	IOB	49	IOA19
	21	IOB	48	IOA20
	22	IOB	47	IOA21
	23	IOB	46	IOA22
	24	IOB	45	IOA23
	25	IOB	44	IOA24
	26	IOB	43	IOA25
	27	IOB	42	IOA26
	28	IOB	41	IOA27
	29	IOB	40	IOA28
	30	IOB	39	IOA29
	31	IOB	38	IOA30
	32	IOB	37	IOA31
	33	IOB	36	IOA32
	34	IOB	35	IOA33
	35	IOB	34	IOA34
	36	IOB	33	IOA35
	37	IOB	32	IOA36
	38	IOB	31	IOA37
	39	IOB	30	IOA38
	40	IOB	29	IOA39
	41	IOB	28	IOA40
	42	IOB	27	IOA41
	43	IOB	26	IOA42
	44	IOB	25	IOA43
	45	IOB	24	IOA44
	46	IOB	23	IOA45
	47	IOB	22	IOA46
	48	IOB	21	IOA47
	49	IOB	20	IOA48
	50	IOB	19	IOA49
	51	IOB	18	IOA50
	52	IOB	17	IOA51
	53	IOB	16	IOA52
	54	IOB	15	IOA53
	55	IOB	14	IOA54
	56	IOB	13	IOA55
	57	IOB	12	IOA56
	58	IOB	11	IOA57
	59	IOB	10	IOA58
	60	IOB	9	IOA59
	61	IOB	8	IOA60
	62	IOB	7	IOA61
	63	IOB	6	IOA62
	64	IOB	5	IOA63
	65	IOB	4	IOA64
	66	IOB	3	IOA65
	67	IOB	2	IOA66
	68	IOB	1	IOA67

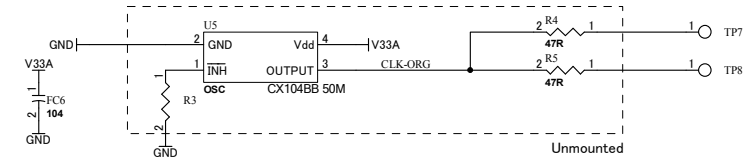
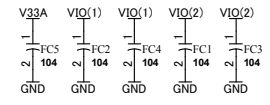
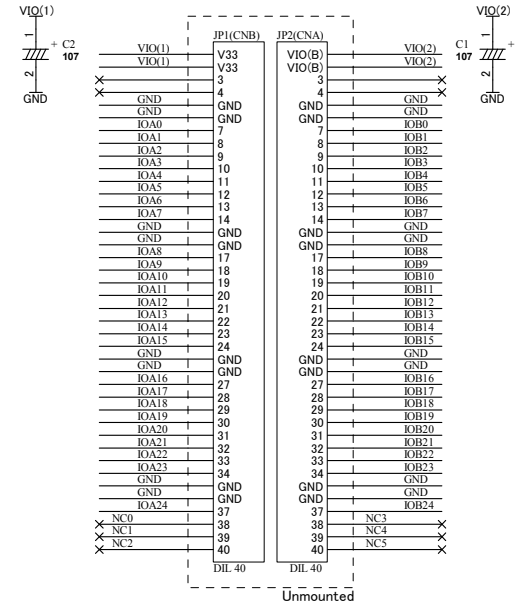

ZKB092R1-SCH-B2.pdf

HUMAN DATA
HuMANDATA LTD.
www.hdl.co.jp

DSN:	TITLE: Universal Board for AP/XP68 Series
DOC No:	ZKB-092
FILE: ZKB092B.sch	DATE: 17-Nov-2017 12:57:25
Sheet: 1	1 / 1