

電源コネクタ

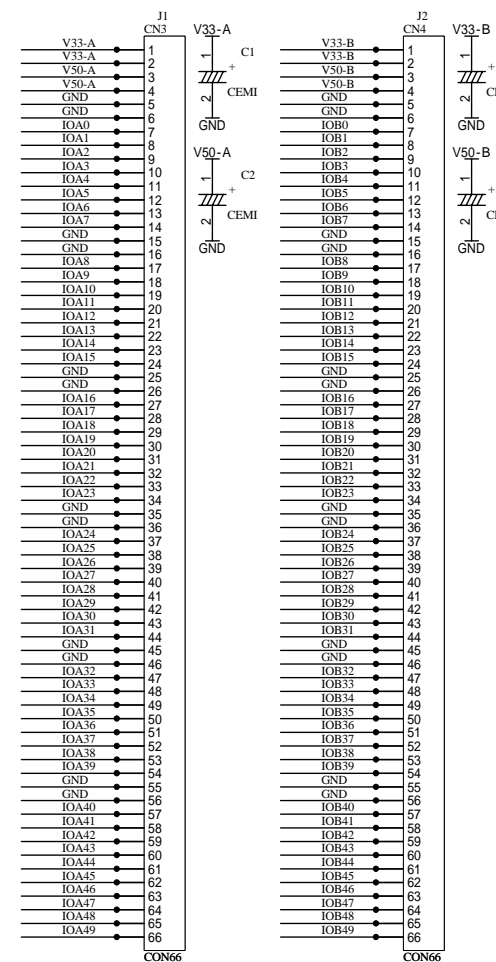

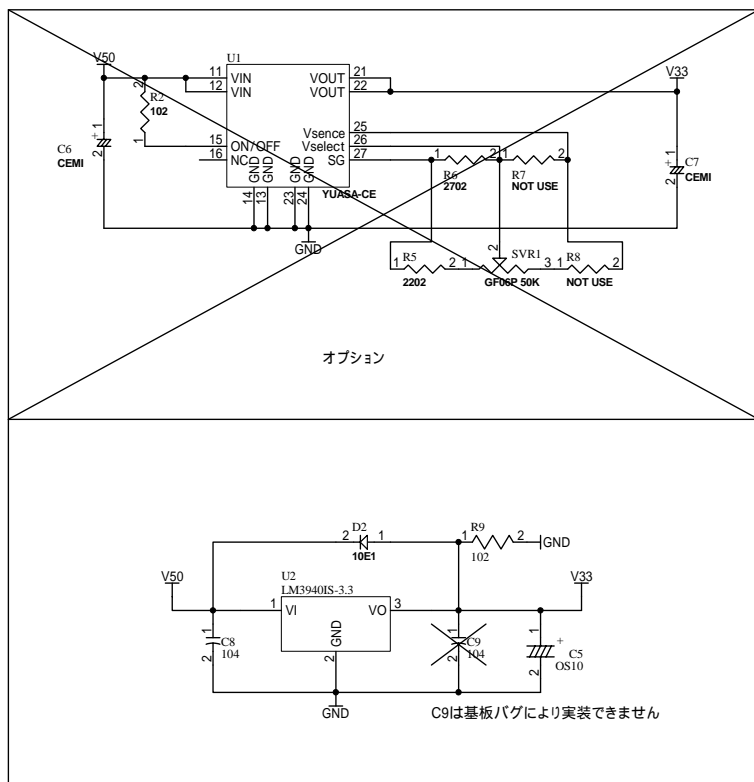

LCD I/F

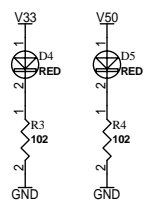
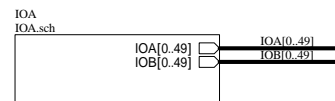
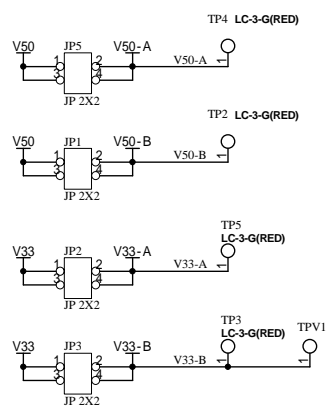
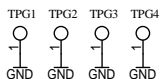
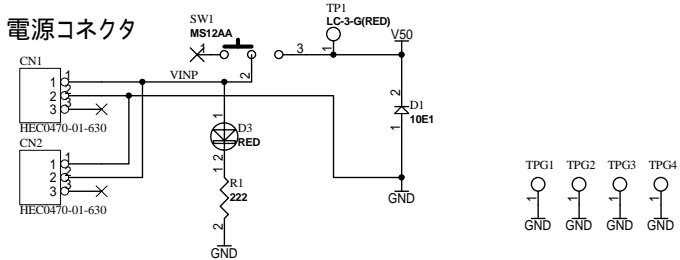
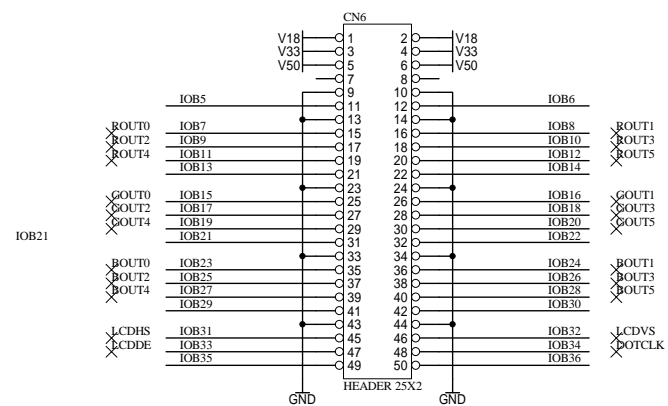
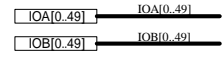
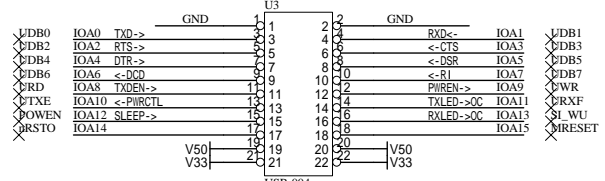

USB-004

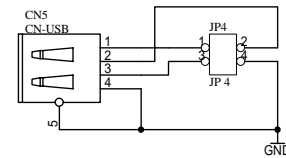

USB-IP

CF CARD

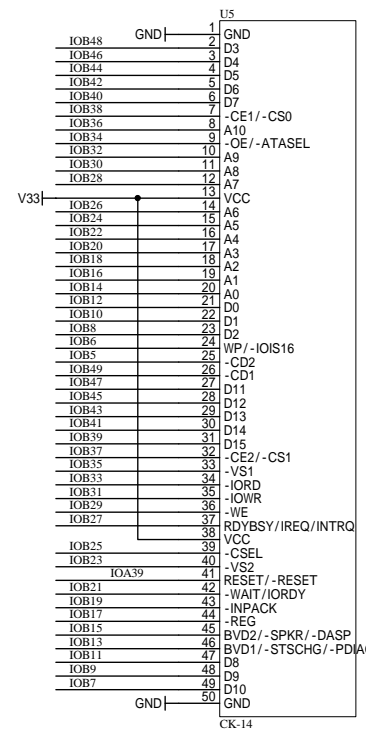

他に接続されていません

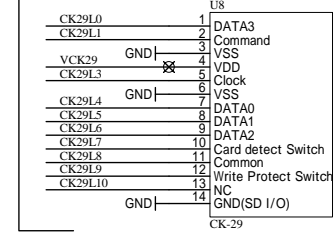

SD CARD

他に接続されていません

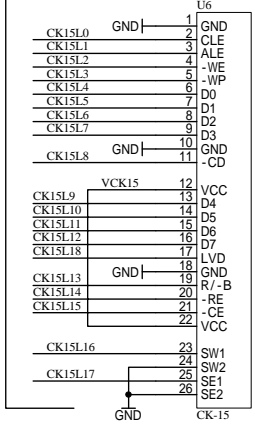

SMART MEDIA

他に接続されていません

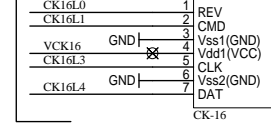

MMC CARD

他に接続されていません

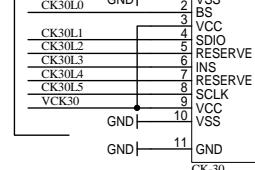

Memory Stick

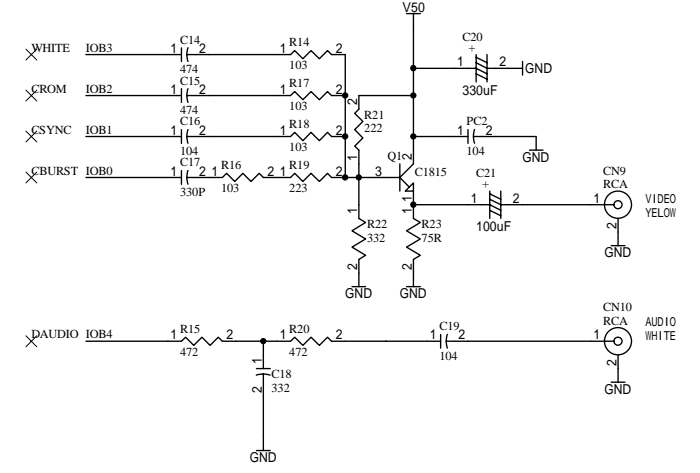

回路定数は一例です

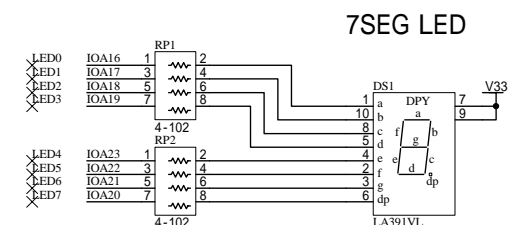

7SEG LED

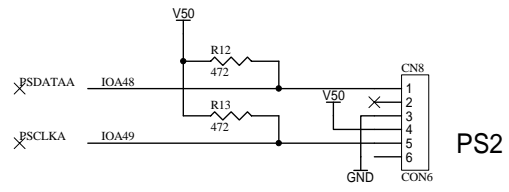

PS2

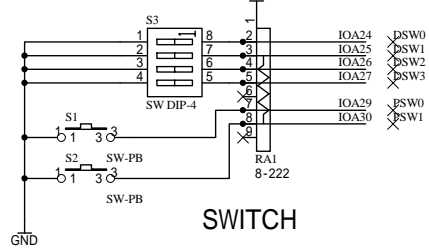

SWITCH

RS-232C

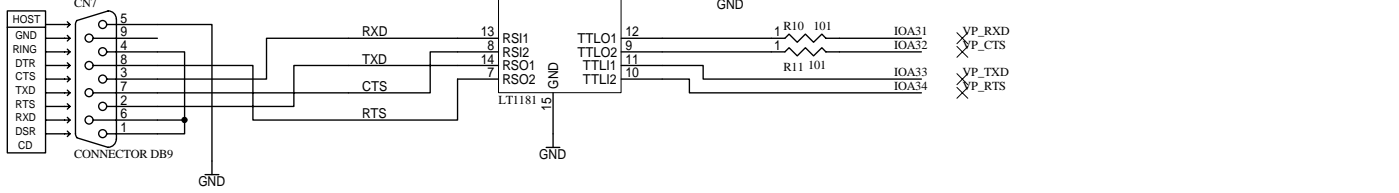

		<p>ACM/XCM対応実験基板</p>		
				DOC. No.
<p>HuMANDATA LTD. OSAKA JAPAN www.hdl.co.jp</p>		<p>Date: 9-Nov-2004 14:55:50</p>	<p>File: IOA.sch</p>	<p>Sheet 2 of 2</p>