

|        |        |
|--------|--------|
| V33P   | V33P   |
| VIO(A) | VIO(A) |
| VIO(B) | VIO(B) |
| V12    | V12    |
| GND    | GND    |

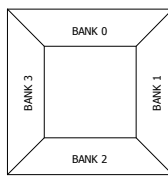
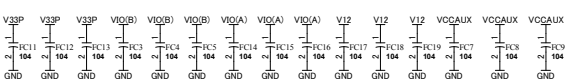
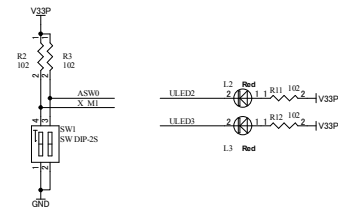
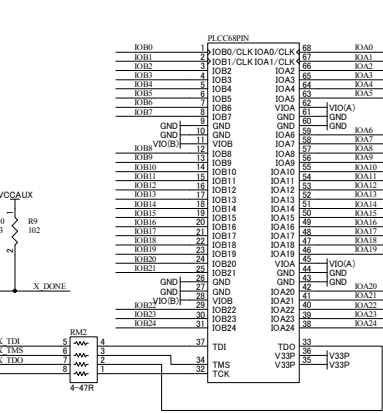
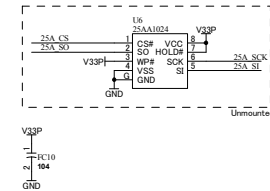
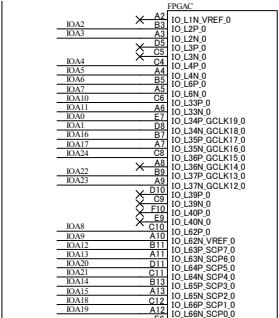
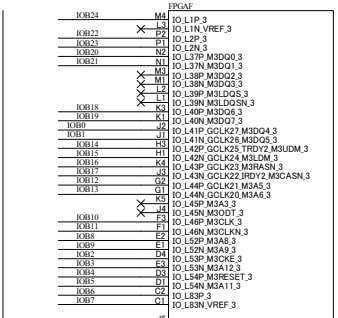
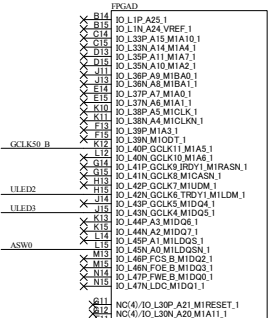
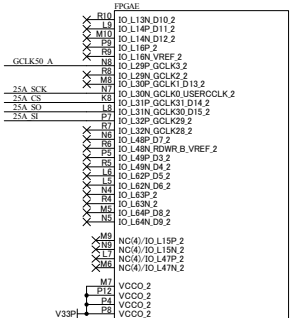
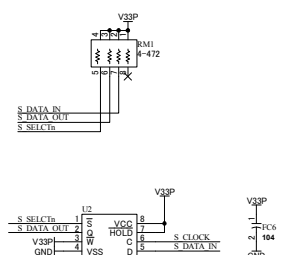
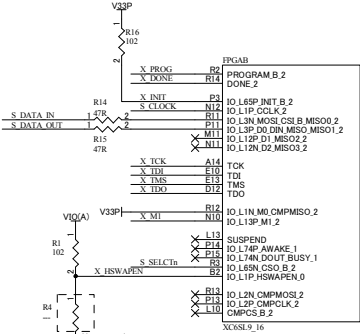
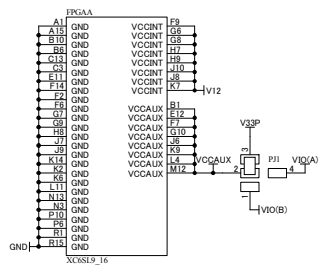
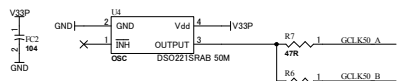
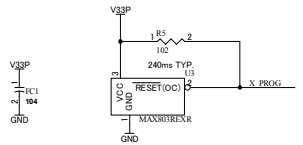
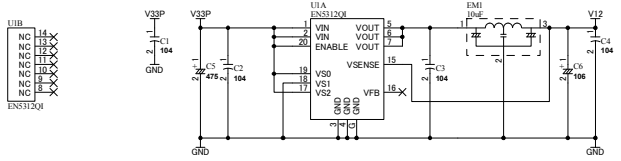

**HUMAN DATA**  
 HuMANDATA LTD.  
 OSAKA JAPAN  
 www.hdl.co.jp/en/(Global)  
 www.hdl.co.jp/(Japan)

SPARTAN-6 PLCC68 FPGA Module

DOC. No. XP68-01

A3

Date: 25-Apr-2012 14:50:09

File: BP68S6A.sch

Sheet 1 of 1

XP6801R1-SCH-A3.pdf