

V33A	V33A
VIO(B)	VIO(B)
V12	V12
V18	V18
V12 MGT	V12 MGT
V09_REF	V09_REF
V25	V25
GND	GND

V12	VCCINT
V25	VCCAUX
V18	VCCO_3
V33A	VCCO_2
V33A	VCCO_1
VIO(B)	VCCO_0

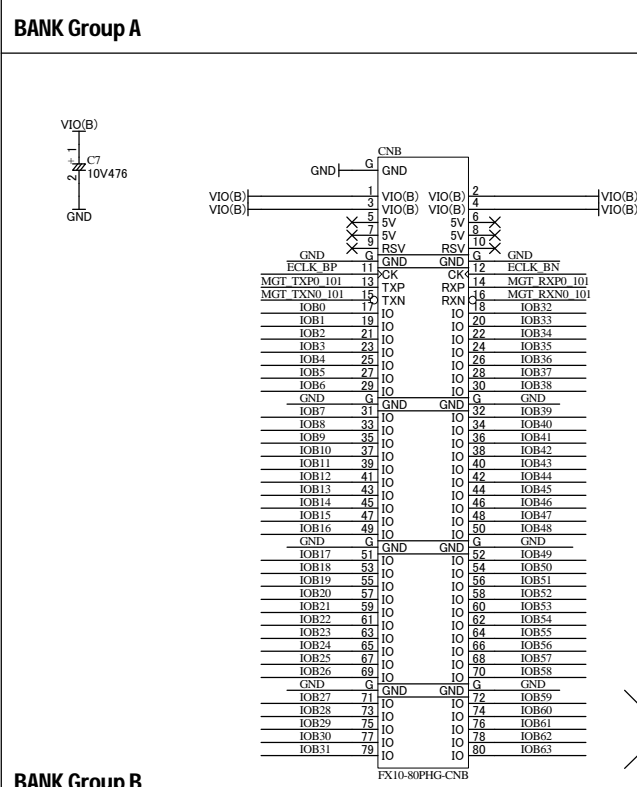
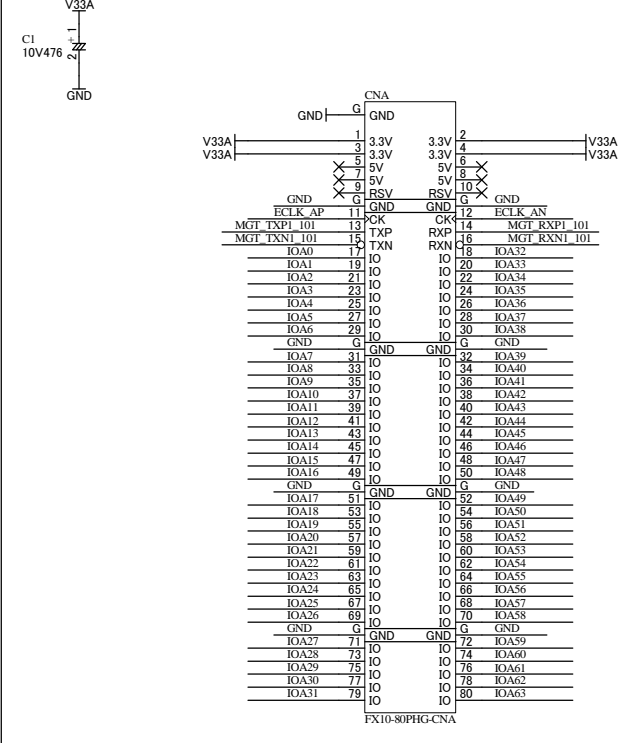
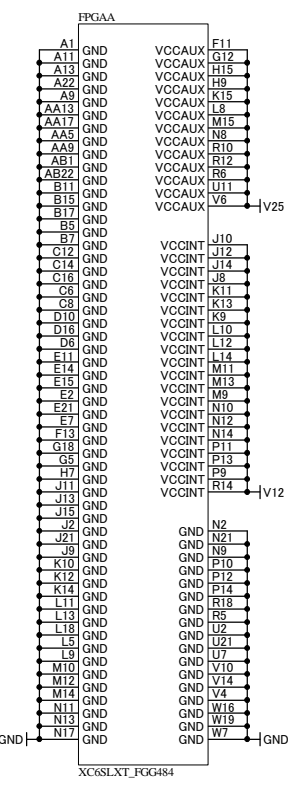
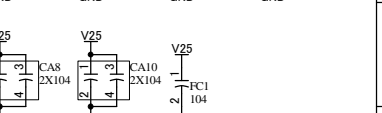
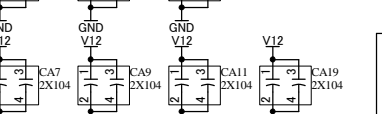
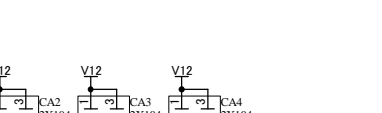
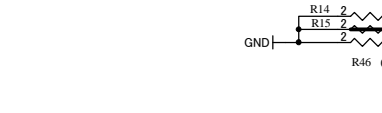
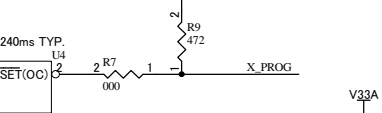
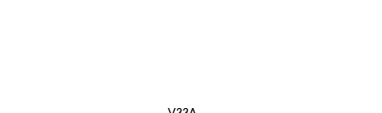
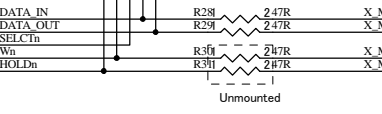
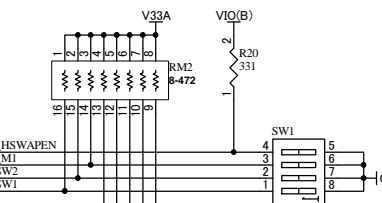
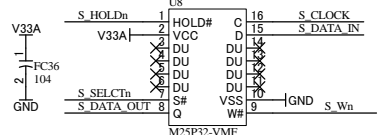
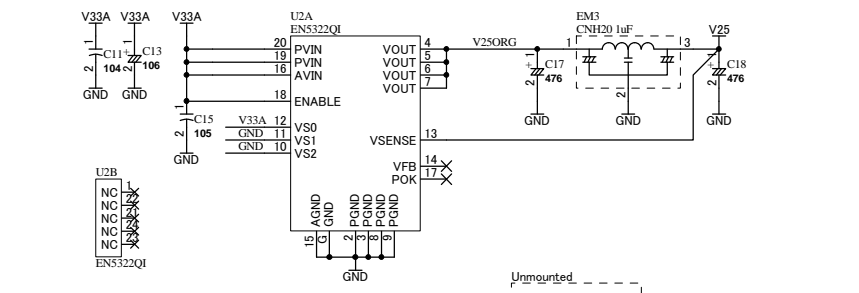
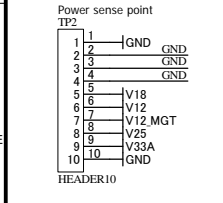
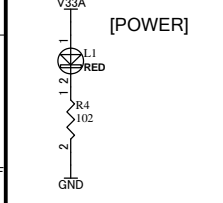
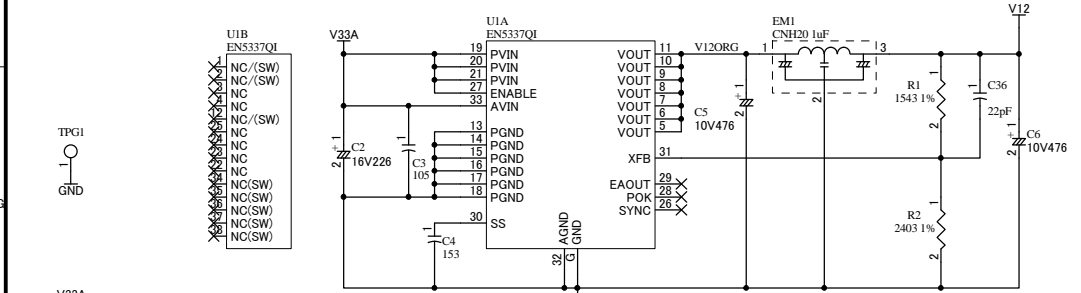

HUMAN DATA

HuMANDATA LTD.
OSAKA JAPAN
www.hdl.co.jp/en/(Global)
www.hdl.co.jp/(Japan)

Date: 9-May-2014 13:05:04

Spartan-6 LXT FGG484 FPGA Board

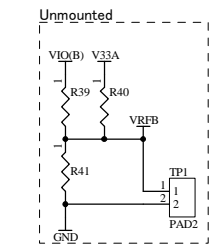
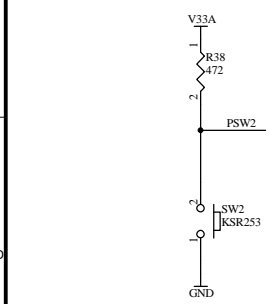
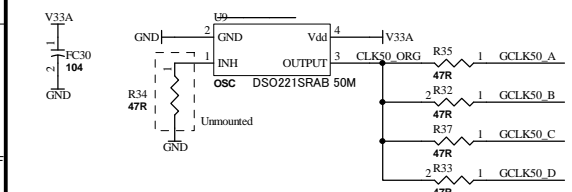
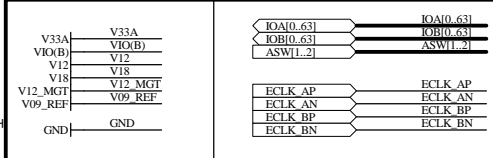

BANK Group B

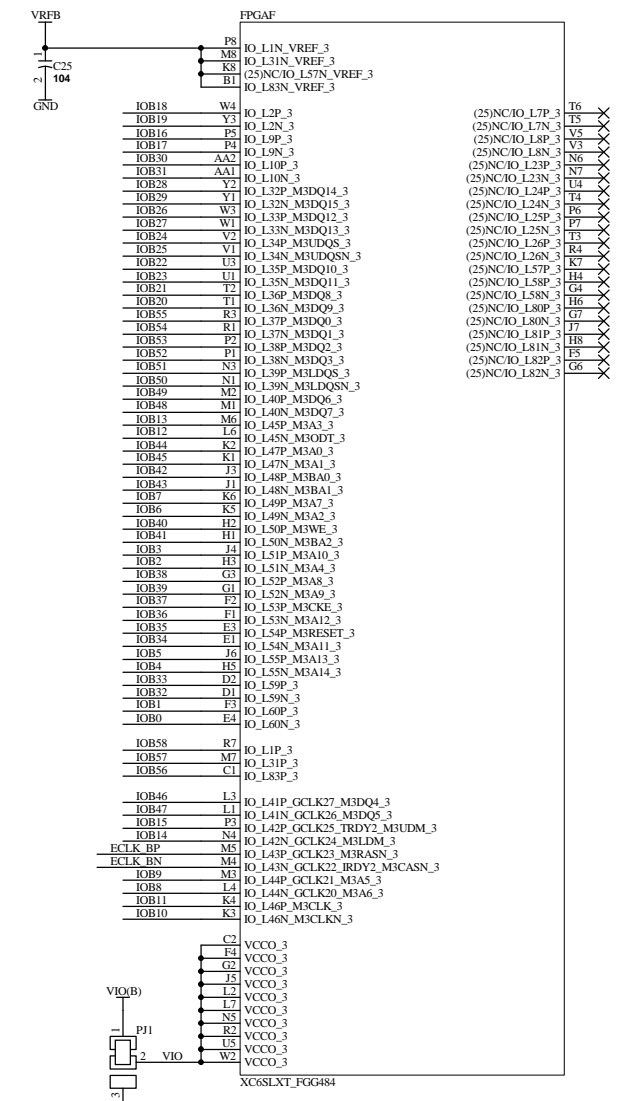

BANK Group A

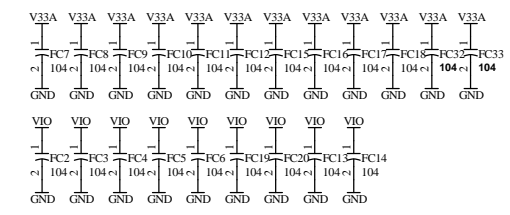
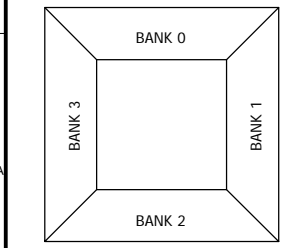
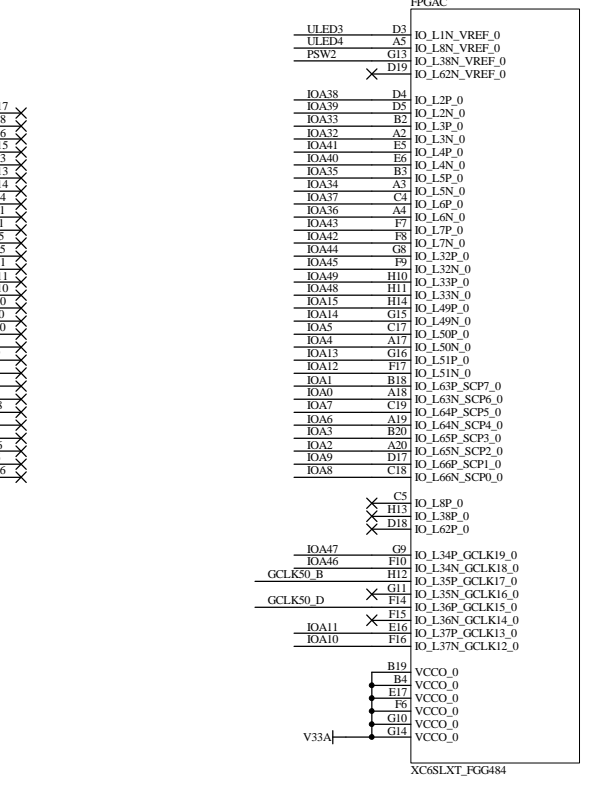
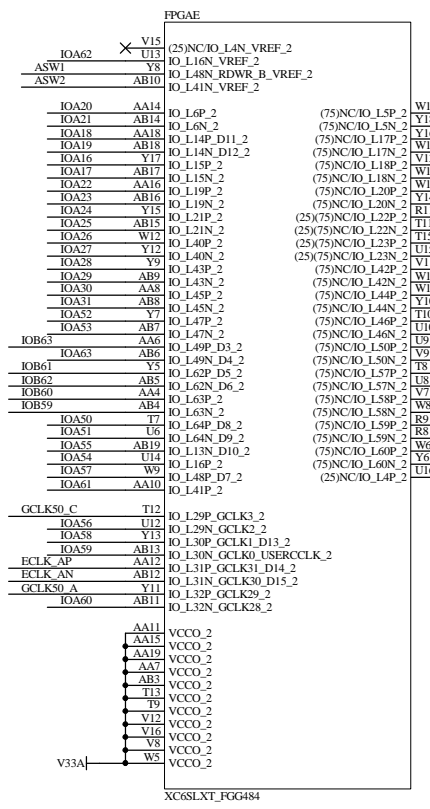

HuMANDATA LTD.
OSAKA JAPAN
www.hdl.co.jp/en/(Global)
www.hdl.co.jp/(Japan)

Spartan-6 LXT FGG484 FPGA Board

DOC. No. XCM-111

Date: 9-May-2014 13:05:04

File: IO_1.sch

Sheet 2 of 3

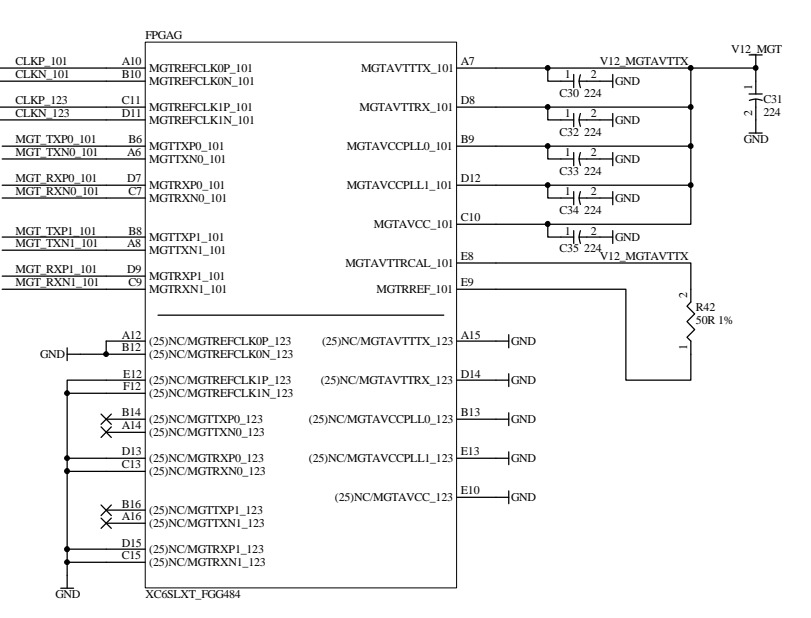
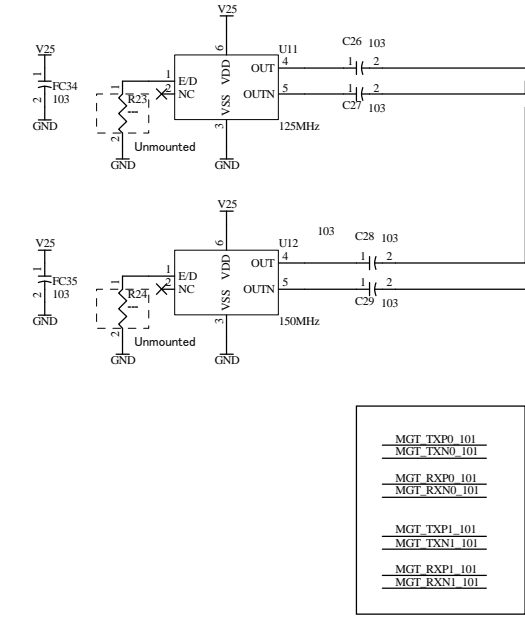
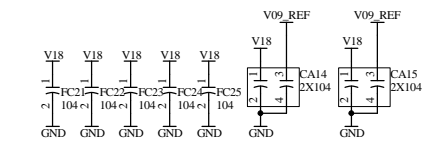
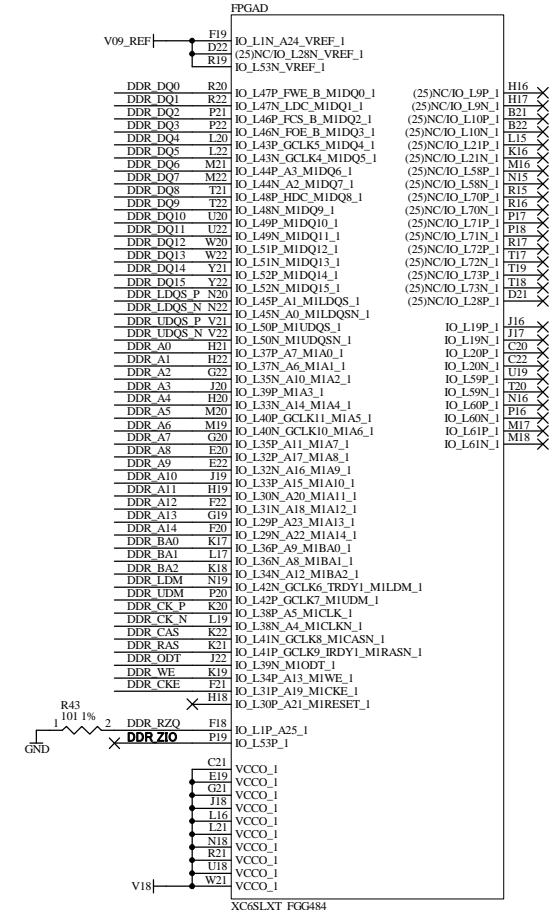
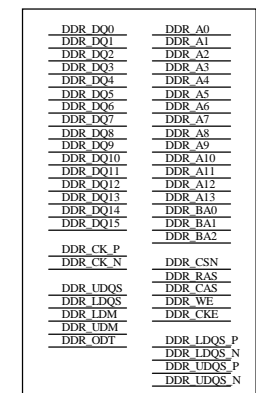
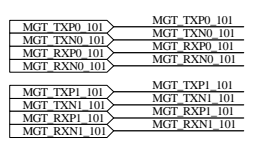
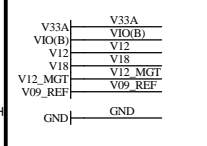

Hi-Speed Transceiver (RocketIO)

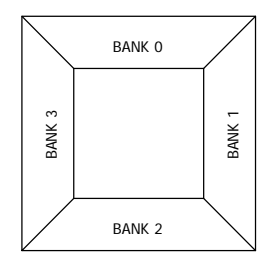
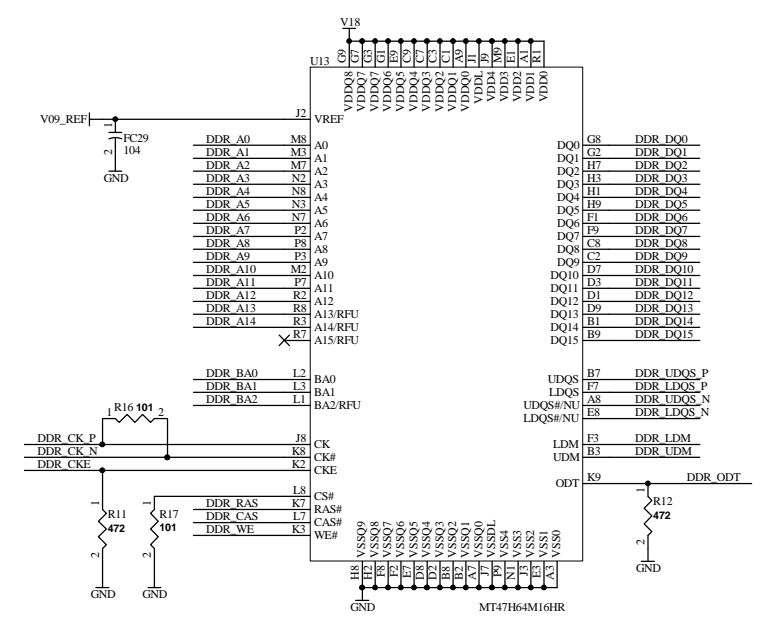
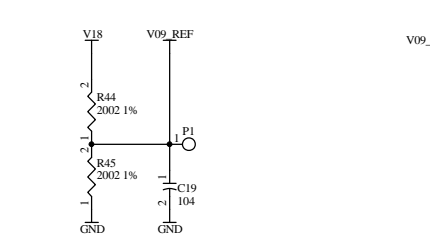

DDR2SDRAM



HuMANDATA LTD.
OSAKA JAPAN
www.hdl.co.jp/en/(Global)
www.hdl.co.jp/(Japan)

Spartan-6 LXT FGG484 FPGA Board

DOC. No. XCM-111

B