

V33_A
V33_A
V33_A
V12
V12
V18
V18
V18
V09_TTR
V09_REF
GND

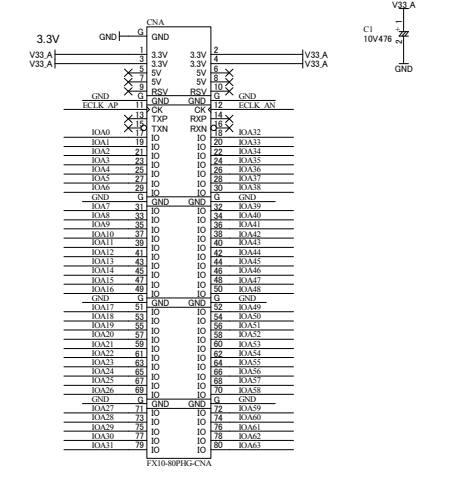

BANK A

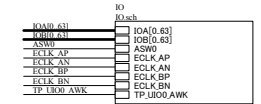
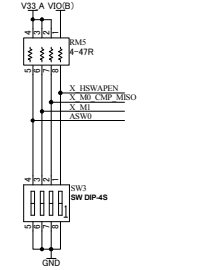
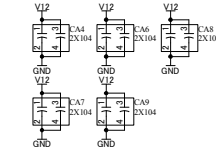
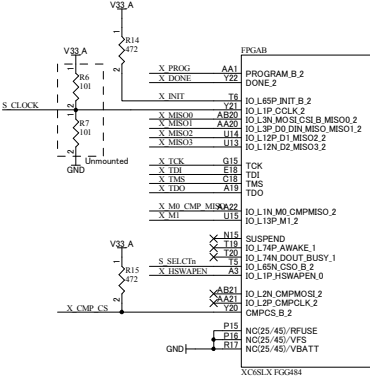
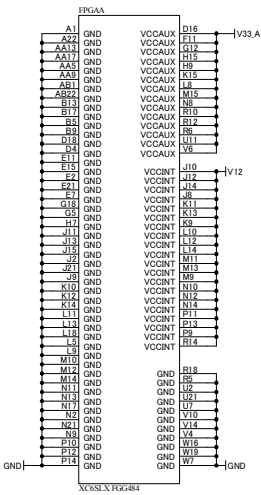
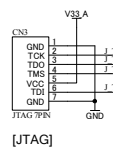
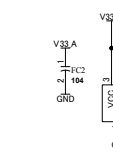
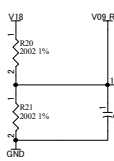
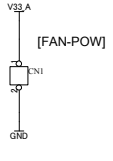
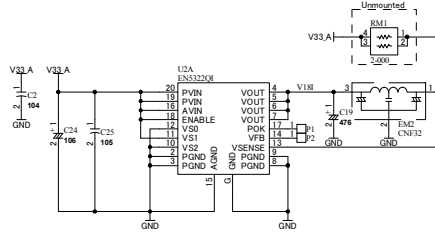
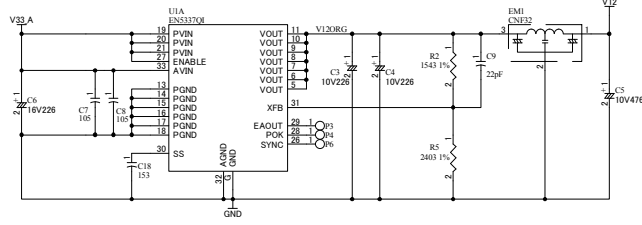
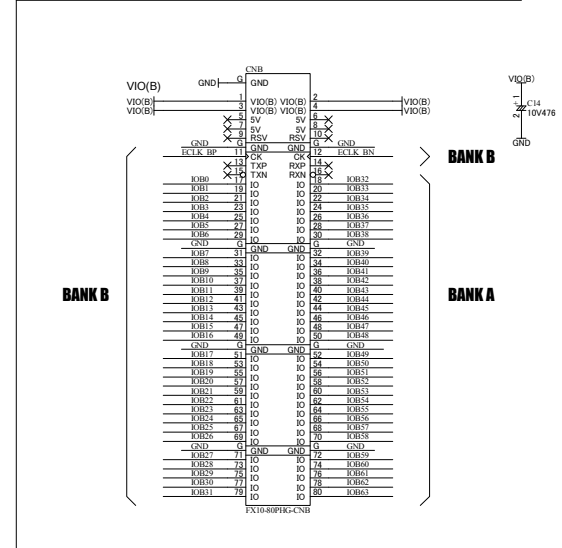

BANK B

XCM110R1-SCH-B3.pdf

HUMAN DATA		SPARTAN-6 FG484 FPGA Board	
HuMANDATA LTD. OSAKA JAPAN www.hdl.co.jp/en/(Global) www.hdl.co.jp/(Japan)		DOC. No.	XCM-110
Date:	11-May-2012	File:	XCM110B.sch
	14:25:04	Sheet	1 of 2

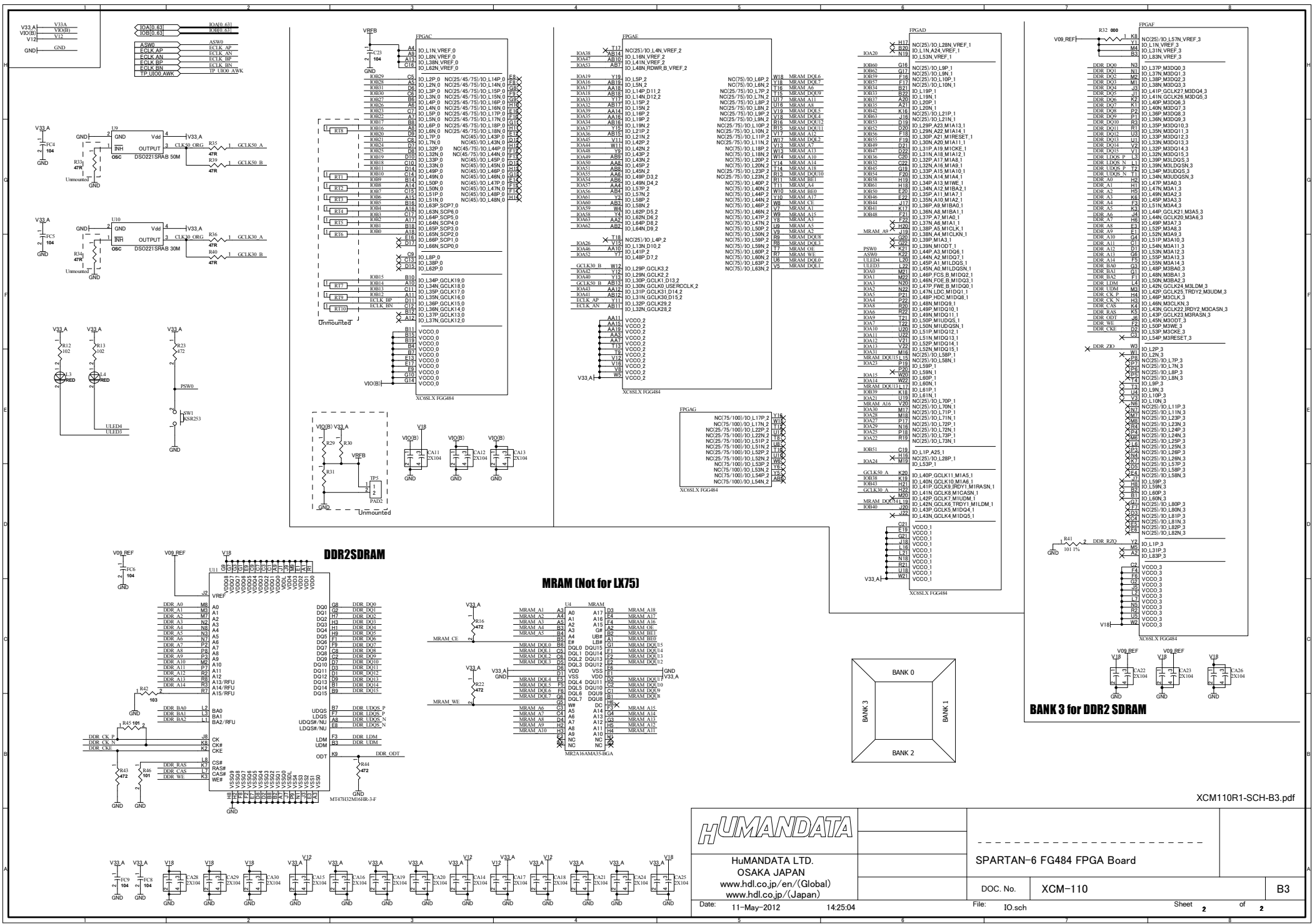

HUMAN DATA
HuMANDATA LTD.
OSAKA JAPAN
www.hdl.co.jp/en/(Global)
www.hdl.co.jp/(Japan)

SPARTAN-6 FG484 FPGA Board

DOC. No. XCM-110

Date: 11-May-2012 14:25:04

XCM110R1-SCH-B3.pdf

File: IO.sch Sheet 2 of 2