

XCM107R2-SCH-E.pdf

<p>HUMAN DATA</p>	2010/02/03	Virtex5 LX30T/50T FPGA Board	
	<p>HuMANDATA LTD. OSAKA JAPAN www.hdl.co.jp/en/(Global) www.hdl.co.jp/(Japan)</p>		<p>DOC. No. XCM-107</p>
Date: 3-Feb-2010 16:51:19		File: XCM107E.sch	
		Sheet 1 of 4	E

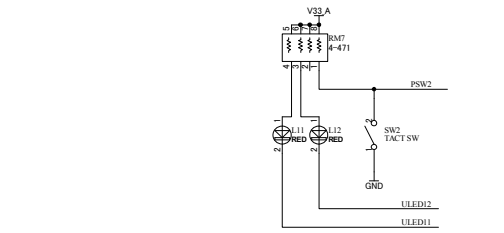
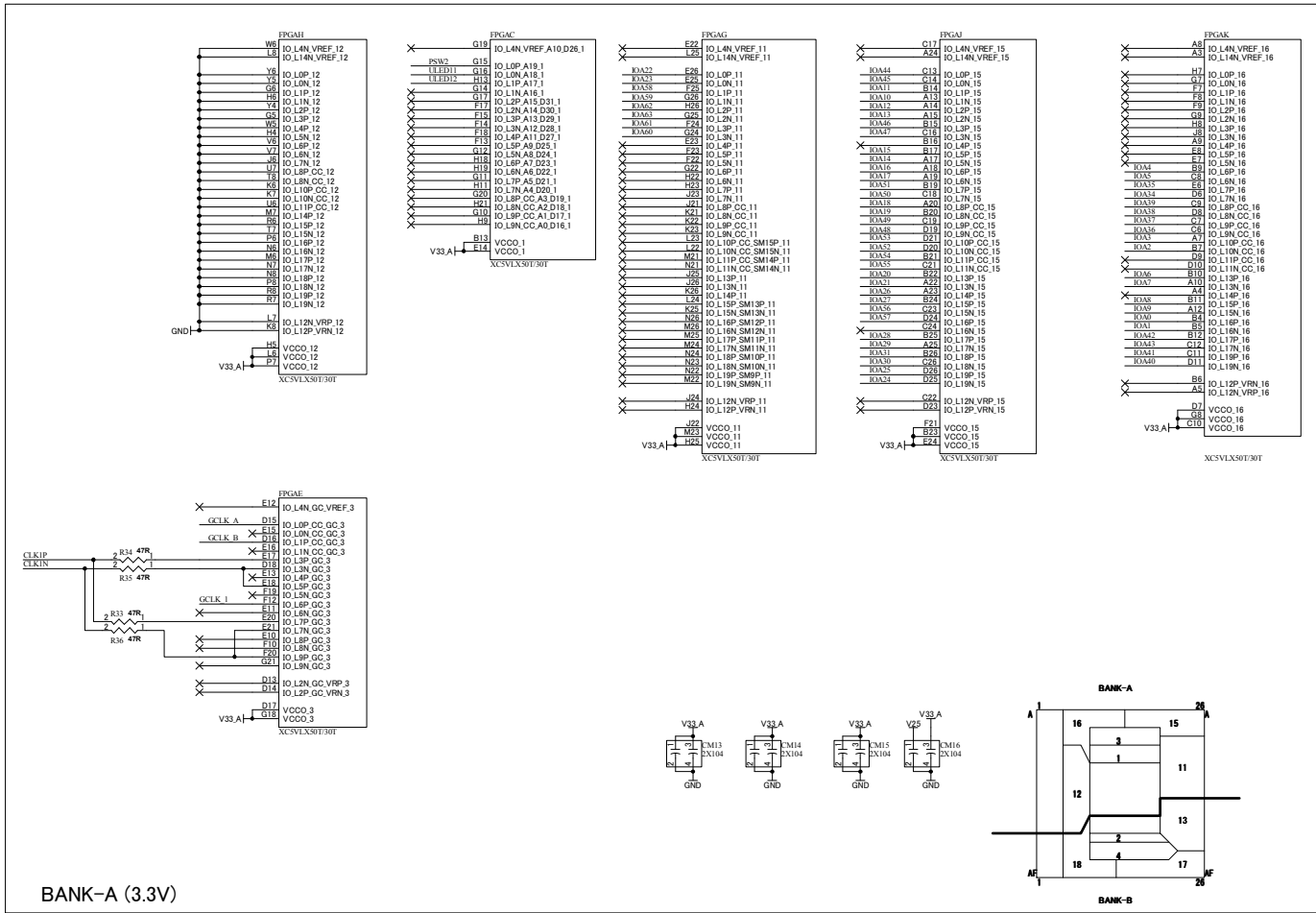
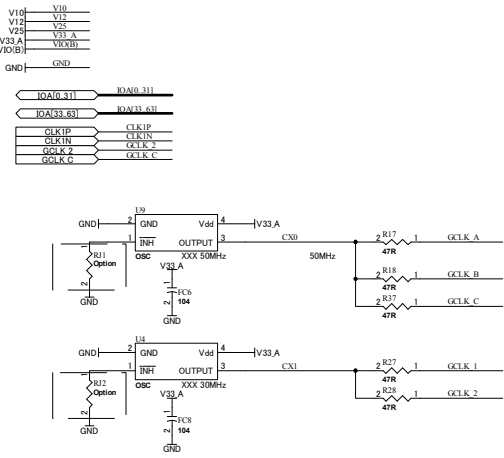

	2010/02/03			
	HuMANDATA LTD. OSAKA JAPAN www.hdl.co.jp/en/(Global) www.hdl.co.jp/(Japan)	Virtex5 LX30T/50T FPGA Board		
Date: 3-Feb-2010	16:51:20	File: X5IOA.sch	DOC. No. XCM-107	Sheet 2 of 4

XCM107R2-SCH-E.pdf

V10 V10
 V12 V12
 V25 V25
 V33_A V33_A
 VIO(B) VIO(B)
 GND GND
 VREF VREF

IOB17_63 IOB17_63
 CLK3P CLK3P
 CLK2N CLK2N
 GCLK_2 GCLK_2
 GCLK_C GCLK_C

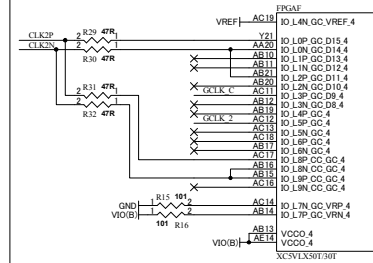
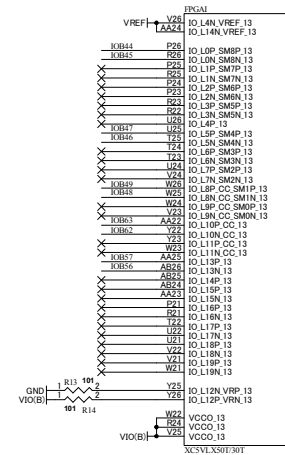
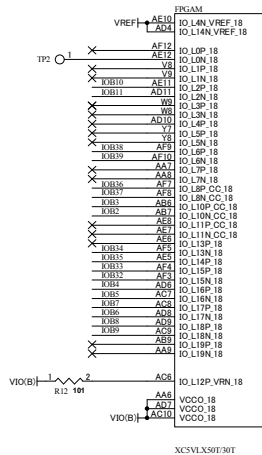
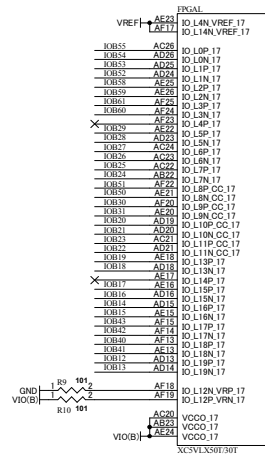

BANK-B

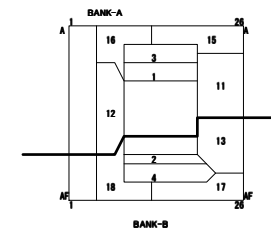
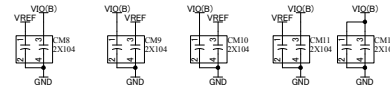

XCM107R2-SCH-E.pdf

	2010/02/03	Virtex5 LX30T/50T FPGA Board		E
	HuMANDATA LTD. OSAKA JAPAN www.hdl.co.jp/en/(Global) www.hdl.co.jp/(Japan)			
Date: 3-Feb-2010 16:51:20	File: X5IOB.sch	Sheet 3	of 4	

V10| V10
V12| V12
V25| V25
V33A| V33A
V10(B)| V10(B)
GND| GND
VREF| VREF

DEA_RXP| DEA_RXP
DEA_RZN| DEA_RZN
DEA_TXP| DEA_TXP
DEA_TXN| DEA_TXN
DEB_RXP| DEB_RXP
DEB_RZN| DEB_RZN
DEB_TXP| DEB_TXP
DEB_TXN| DEB_TXN
ROB0| ROB0
ROB1| ROB1
ROA32| ROA32
ROA33| ROA33

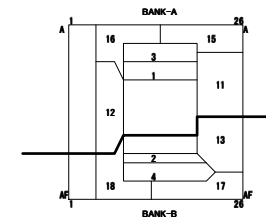
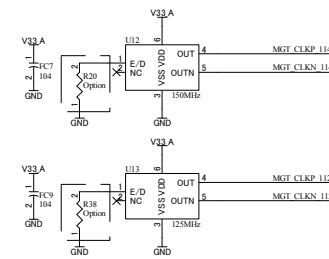
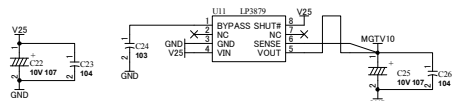
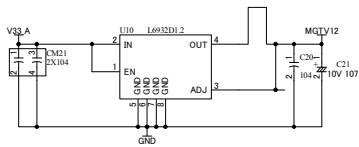
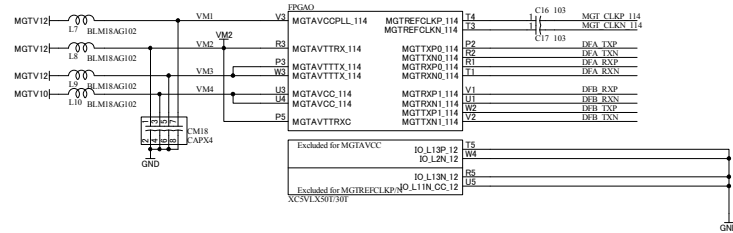
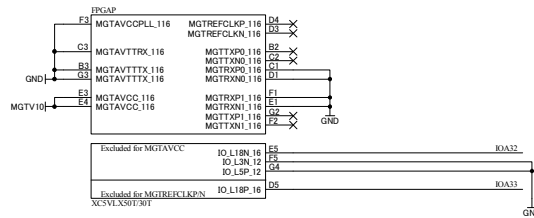
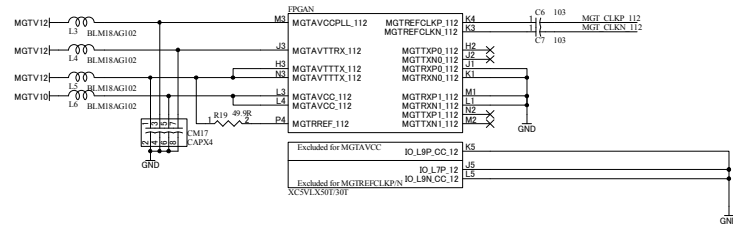
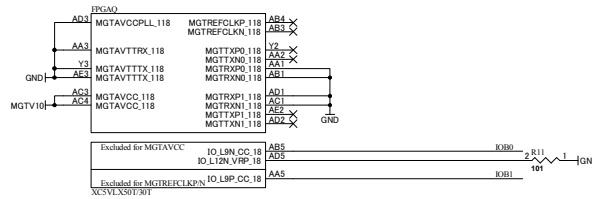

<p>HUMAN DATA LTD. OSAKA JAPAN www.hdl.co.jp/en/(Global) www.hdl.co.jp/(Japan)</p>	2010/02/03	Virtex5 LX30T/50T FPGA Board		E
	Date: 3-Feb-2010 16:51:20			