

1 2 3 4 5 6 7 8

A

A

View from Top side (Scale 2:1)

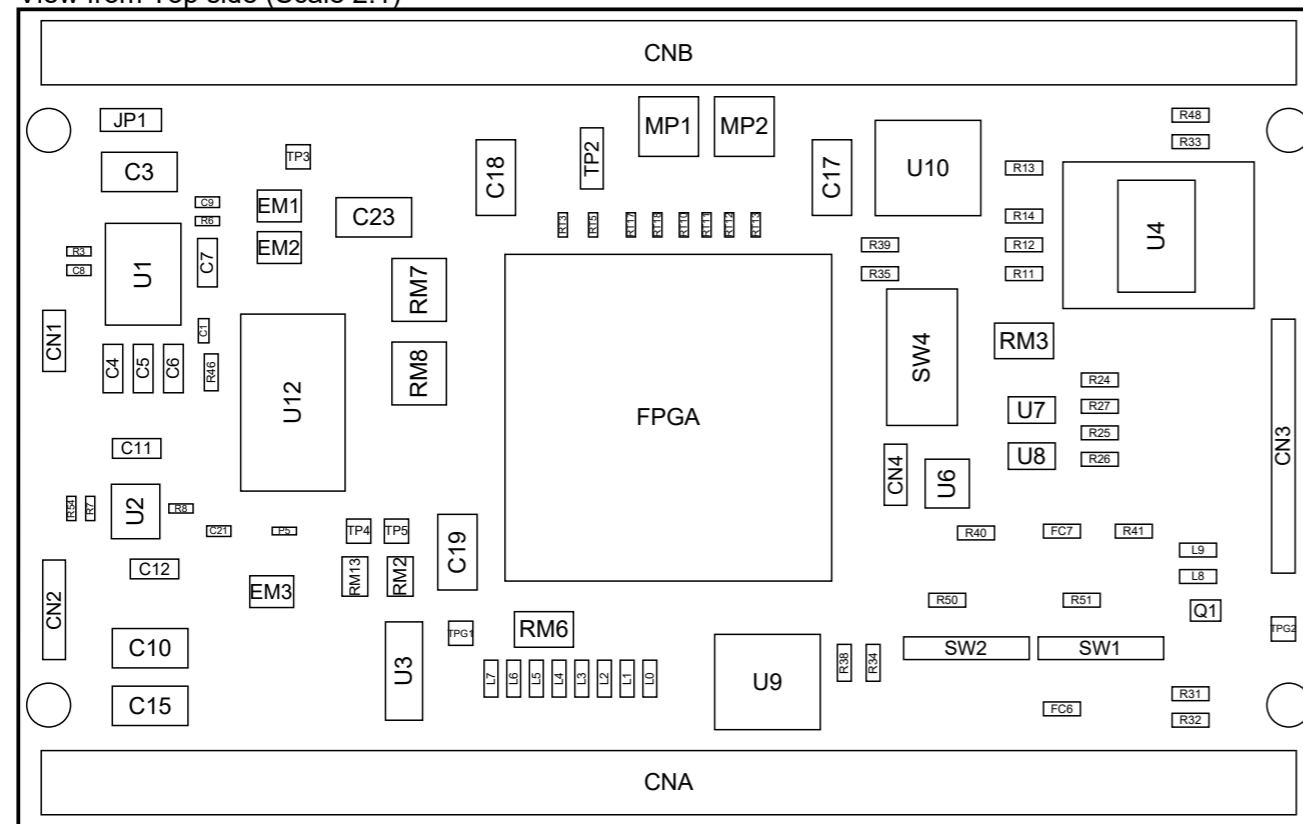

View from Bottom side (Scale 2:1)

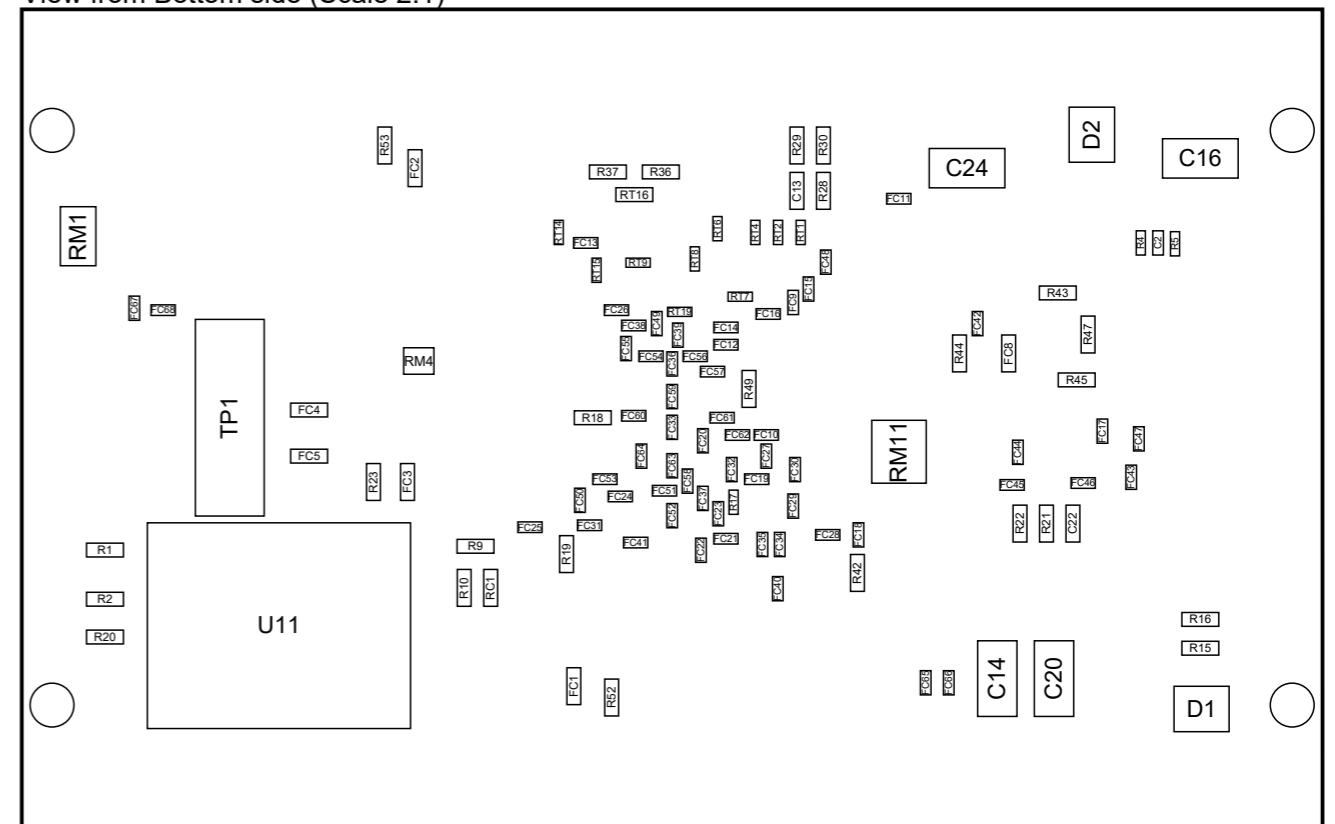

B

B

C

C

D

D

PCB Version : B

HUMANDATA
 HuMANDATA LTD.
 www.hdl.co.jp/ (Japan)
 www2.hdl.co.jp/en/ (Global)

DSN	TITLE: XCM-018 PCB Drawing	
	DOC.No: PCB-XCM-018	REV B
	FILE:	DATE: 2023/03/30 Sheet: 1 / 2

1 2 3 4 5 6 7 8

1 2 3 4 5 6 7 8

A

A

TopLayer (Scale 1:1)

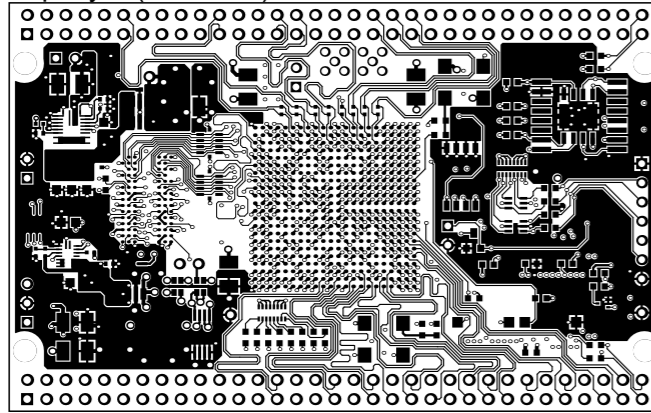

MidLayer1 (Scale 1:1)

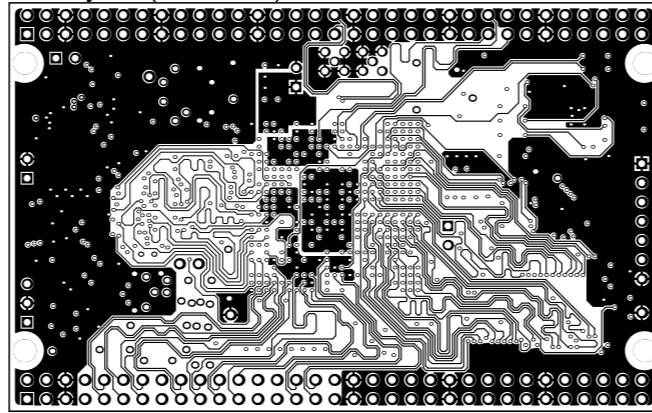

InternalPlane3 (Scale 1:1)

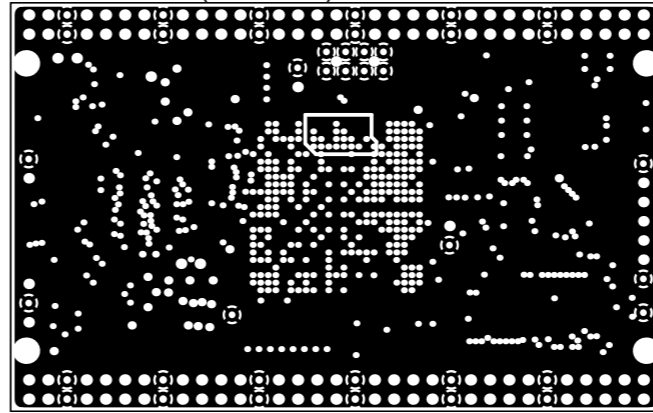

InternalPlane2 (Scale 1:1)

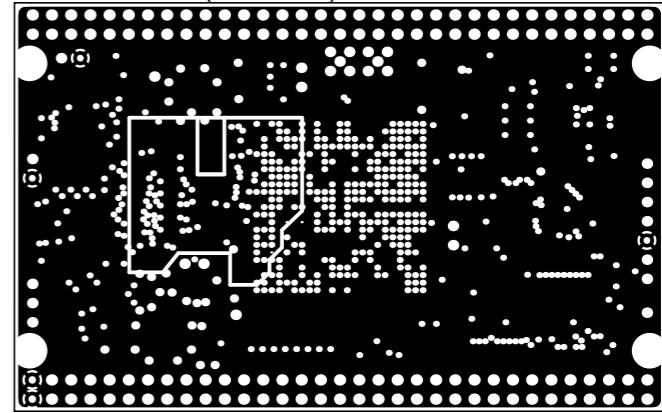

B

B

InternalPlane1 (Scale 1:1)

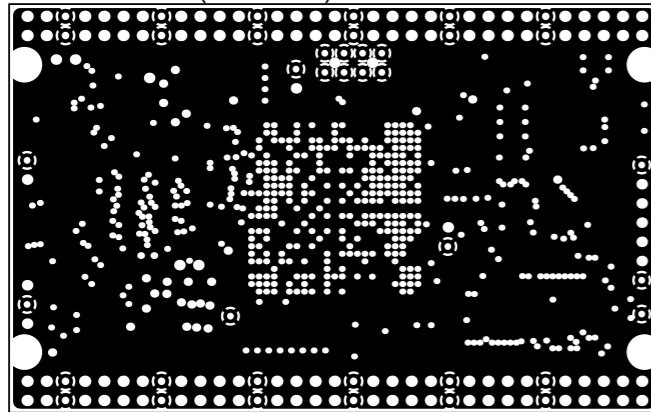

MidLayer3 (Scale 1:1)

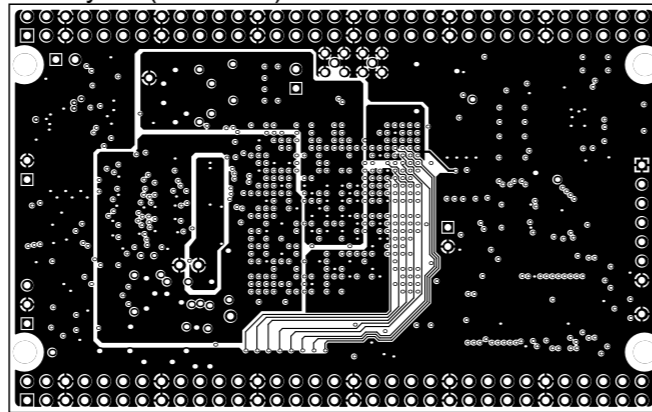

MidLayer2 (Scale 1:1)

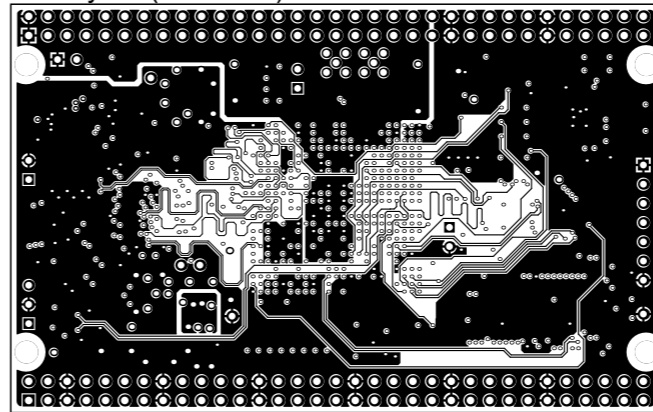

BottomLayer (Scale 1:1)

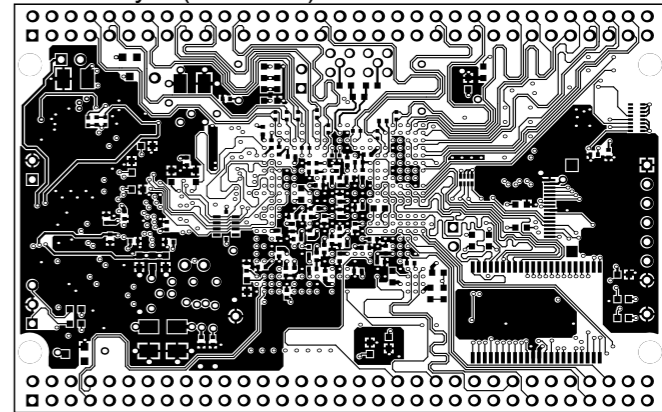

C

C

PCB Version : B

D

D



HuMANDATA LTD.
www.hdl.co.jp/ (Japan)
www2.hdl.co.jp/en/ (Global)

DSN	TITLE: XCM-018 PCB Drawing	
	DOC.No: PCB-XCM-018	REV B
	FILE:	DATE: 2023/03/30 Sheet: 2 / 2

1 2 3 4 5 6 7 8