

V33| V33
 V33.A| V33.A
 V33.B| V33.B
 V12| V12
 V25| V25
 GND| GND

電源回路

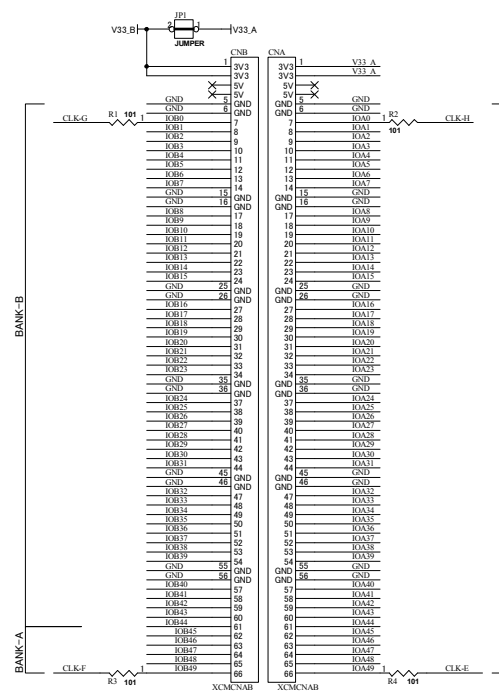

HUMAN DATA		2008/07/16	
HuMANDATA LTD. OSAKA JAPAN www.hdl.co.jp		CycloneIII FPGA Board(PQ240)	
Date: 16-Jul-2008	13:53:36	DOC. No. ACM-018	C
File: ACM018C.sch		Sheet 1 of 2	

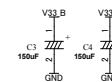
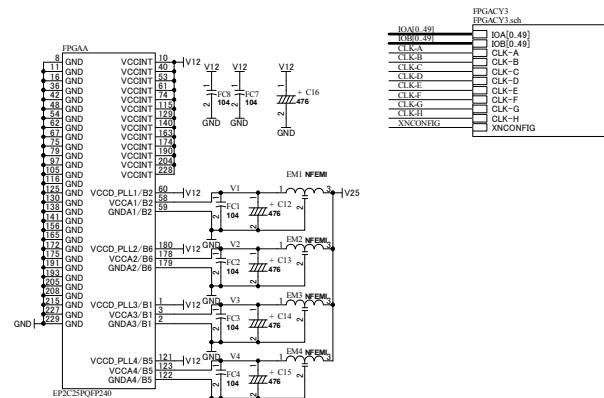
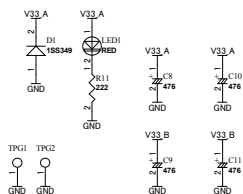
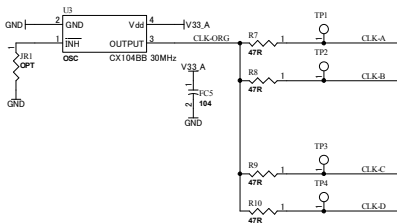
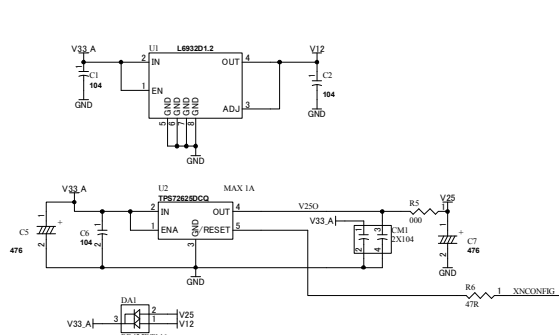
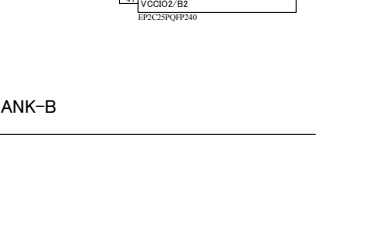
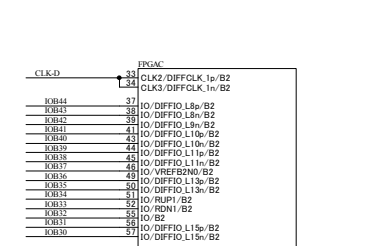
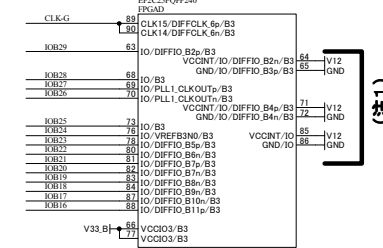
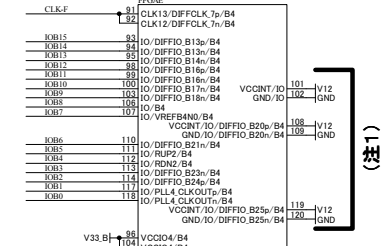
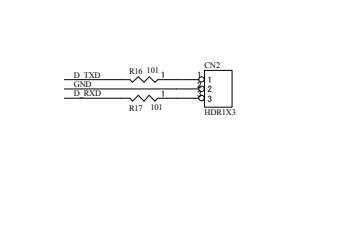
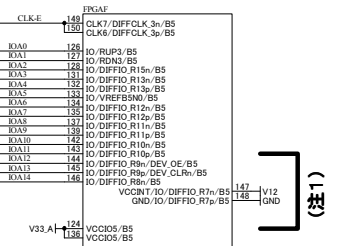
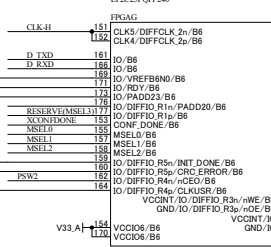
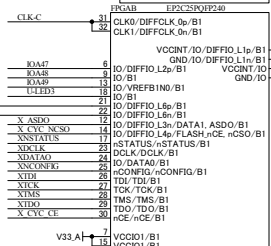
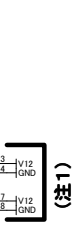
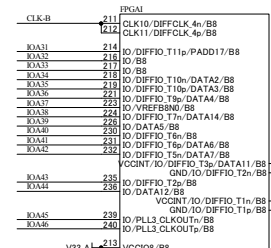
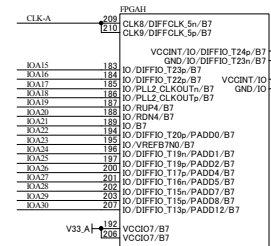
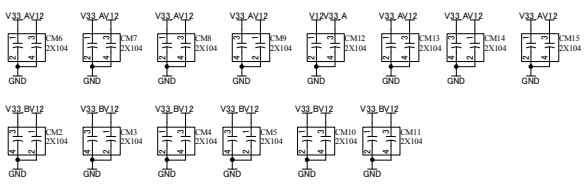
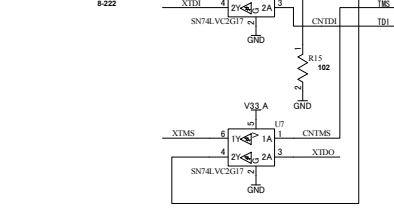
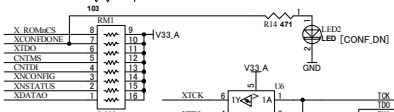
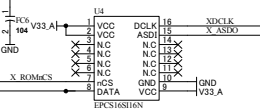
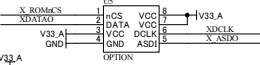
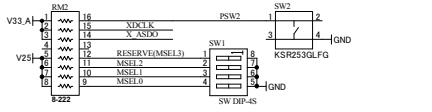
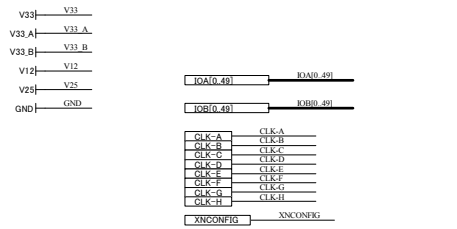

(注1) これらのピンはGNDまたは電源に接続されています。
 (注2) この回路図はEP3C25を基本にしています。