

View from Top side (Scale 2:1)

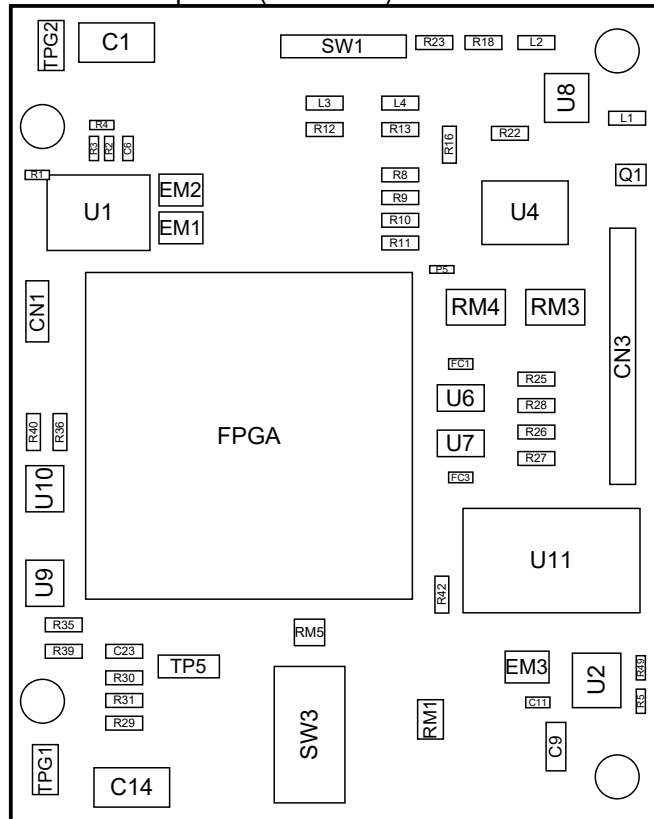

View from Bottom side (Scale 2:1)

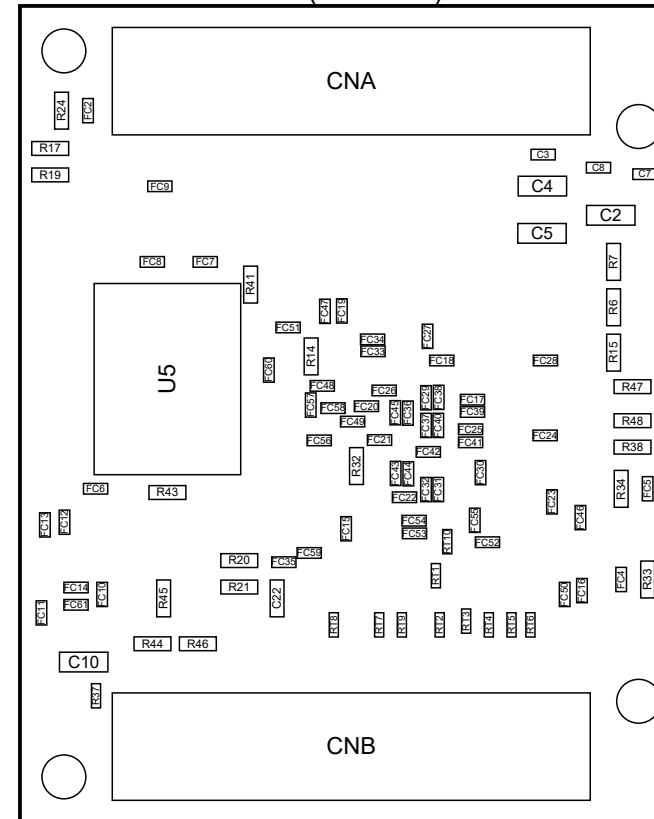

PCB Version : D



HuMANDATA LTD.
www.hdl.co.jp/ (Japan)
www2.hdl.co.jp/en/ (Global)

DSN	TITLE: XCM-110 PCB Drawing	
	DOC.No: PCB-XCM-110	REV C
FILE:	DATE: 2023/07/04	Sheet: 1 / 2

1

2

3

4

5

A

A

B

B

C

C

D

D

TopLayer (Scale 1:1)

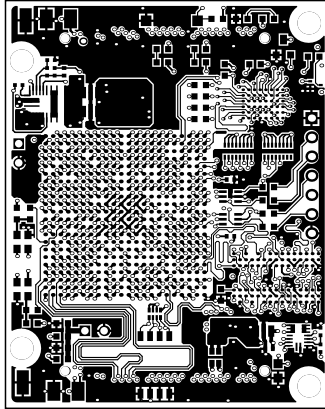

MidLayer1 (Scale 1:1)

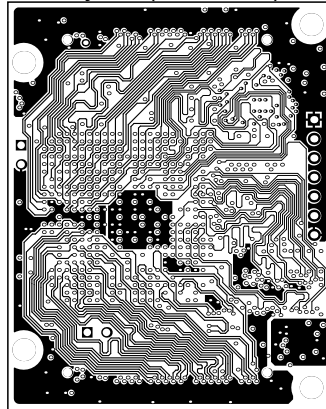

MidLayer3 (Scale 1:1)

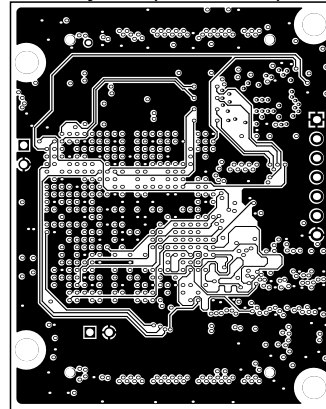

InternalPlane2 (Scale 1:1)

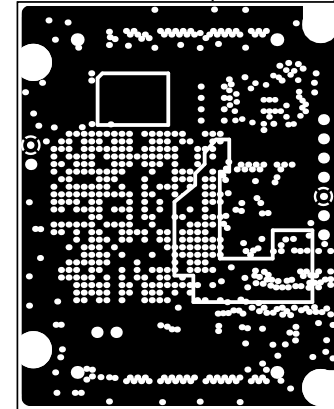

InternalPlane1 (Scale 1:1)

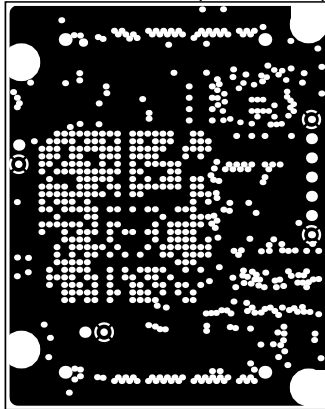

MidLayer2 (Scale 1:1)

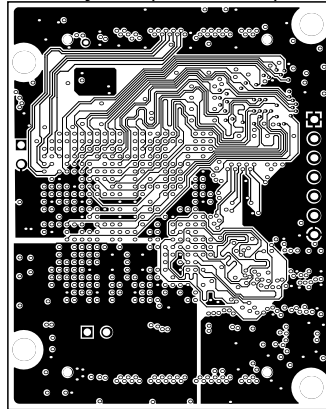

MidLayer4 (Scale 1:1)

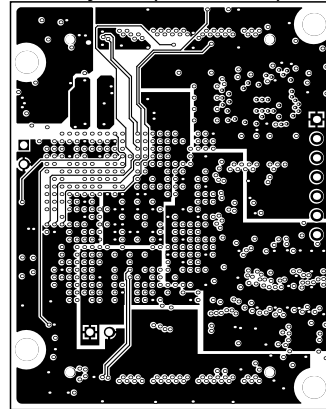

BottomLayer (Scale 1:1)

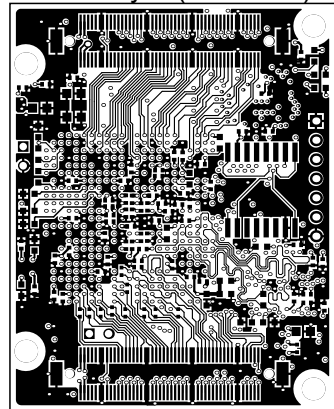

PCB Version : D



HuMANDATA LTD.
www.hdl.co.jp/ (Japan)
www2.hdl.co.jp/en/ (Global)

DSN

TITLE:

XCM-110 PCB Drawing

DOC.No:

PCB-XCM-110

REV

C

FILE:

DATE: 2023/07/04

Sheet: 2 / 2

1

2

3

4

5

V1_20191224