

REV.	DESCRIPTION	DRW.	CHK.	APP.	DATE
A	RELEASE				
B	增修圖面料號	王日賜	王盛富	郭豐榮	95.05.30

Ordering information: $\triangle B$
 22X8572-XXS10X-XXX-A

B PBT
 N Nylon-6T
 L LCP
 Number of Contact
 04~80

G Gold Plated
 T Tin Plated
 H Duplex plated

Contact Plating
 01 Normal
 10 10 μ "
 :
 :

Color

SPECIFICATIONS

Current Rating:
 3 Amp
 Insulator resistance:
 5000 Megohms Min.
 Contact Resistance:
 20 m ohms Max.
 Dielectric withstanding:
 AC 500V/minute
 Operating Temperature:
 -40 $^{\circ}$ ~ +105 $^{\circ}$ C
 Contact Material:
 Phosphor Bronze
 Insulator Material:

High Temperature Thermoplastic
 +Glass Fibre UL94V-0
 Color: Black
 Finish:
 Gold, Tin or Duplex plated
 Standard: Gold flash all over
 Duplex plated:
 Gold plated on contact area
 Tin on solder area

2.54 \pm 0.05

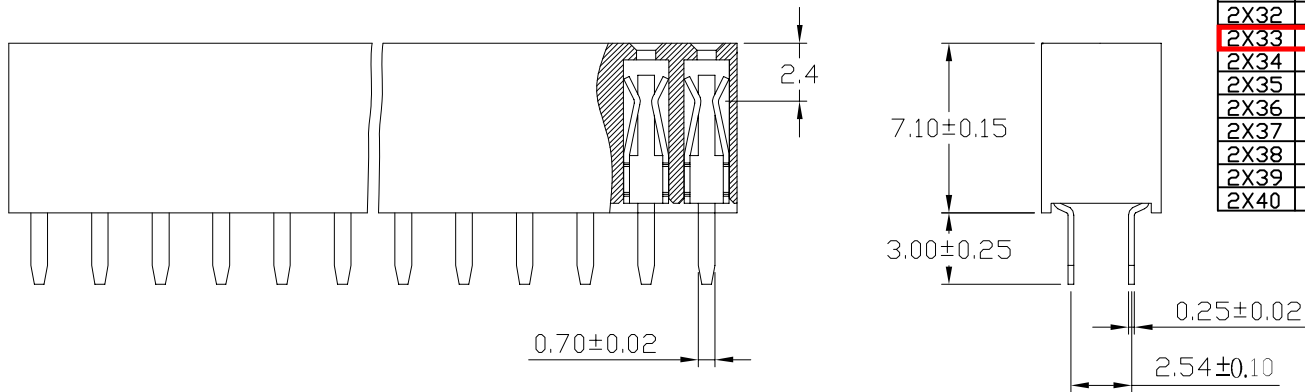
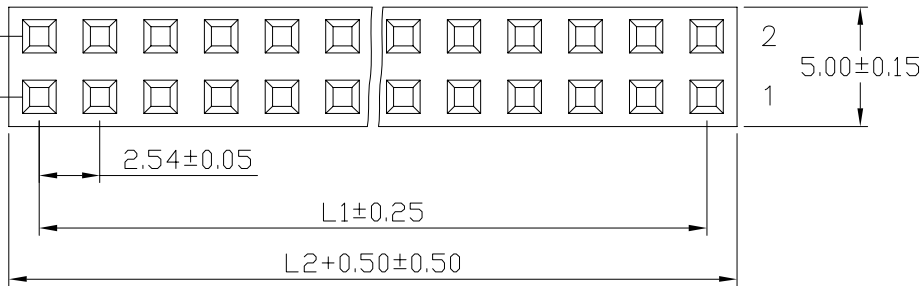

RoHS Compliant

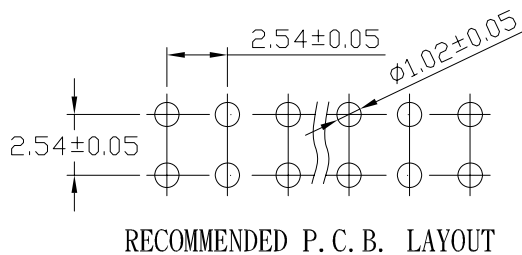

Cir-cuits	Dimension mm	
	L1	L2
2X2	2.54	5.08
2X3	5.08	7.62
2X4	7.62	10.16
2X5	10.16	12.70
2X6	12.70	15.24
2X7	15.24	17.78
2X8	17.78	20.32
2X9	20.32	22.86
2X10	22.86	25.40
2X11	25.40	27.94
2X12	27.94	30.48
2X13	30.48	33.02
2X14	33.02	35.56
2X15	35.56	38.10
2X16	38.10	40.64
2X17	40.64	43.18
2X18	43.18	45.72
2X19	45.72	48.26
2X20	48.26	50.80
2X21	50.80	53.34
2X22	53.34	55.88
2X23	55.88	58.42
2X24	58.42	60.96
2X25	60.96	63.50
2X26	63.50	66.04
2X27	66.04	68.58
2X28	68.58	71.12
2X29	71.12	73.66
2X30	73.66	76.20
2X31	76.20	78.74
2X32	78.74	81.28
2X33	81.28	83.82
2X34	83.82	86.36
2X35	86.36	88.90
2X36	88.90	91.44
2X37	91.44	93.98
2X38	93.98	96.52
2X39	96.52	99.06
2X40	99.06	101.60

10-66S10B-01G

成品規格圖		APP.	ANGLES	$\pm 3^{\circ}$	SIZE	A4
TITLE	2.54mm Female Header Straight Type	CHK.	LINEAR	0.0 \pm 0.38	SCALE	1:1
PART NO	22X8572-XXS10X-XXX-A			0.00 \pm 0.25	SHEET	1/1
DRW NO	22P850090	DR.				
UNIT	mm(INCH)	PROJECT				